

APRIL 2019

Funded by



STIFTUNG
MERCATOR

Deutsche Bundesstiftung Umwelt

GLOBAL ENERGY SYSTEM BASED ON 100% RENEWABLE ENERGY

Power, Heat, Transport and Desalination Sectors



Study by



P.O.Box 20
FI-53851 Lappeenranta
Finland
Tel.: +358 408171944
Email: manish.thulasi.ram@lut.fi

Albrechtstr. 22
10117 Berlin
Germany
Tel.: +49 30 609 898 810
Email: office@energywatchgroup.org

Authors

LUT Manish Ram, Dmitrii Bogdanov, Arman Aghahosseini, Ashish Gulagi, Solomon A. Oyewo, Michael Child, Upeksha Caldera, Kristina Sadovskaia, Javier Farfan, Larissa S.N.S. Barbosa, Mahdi Fasihi, Siavash Khalili, Christian Breyer

EWG Hans-Josef Fell, Thure Traber, Felix De Caluwe, Georg Gruber, Bernhard Dahlheimer

Please cite this report:

Ram M., Bogdanov D., Aghahosseini A., Gulagi A., Oyewo A.S., Child M., Caldera U., Sadovskaia K., Farfan J., Barbosa LSNS., Fasihi M., Khalili S., Dahlheimer B., Gruber G., Traber T., De Caluwe F., Fell H.-J., Breyer C. Global Energy System based on 100% Renewable Energy – Power, Heat, Transport and Desalination Sectors. Study by Lappeenranta University of Technology and Energy Watch Group, Lappeenranta, Berlin, March 2019.

ISBN: 978-952-335-339-8

ISSN-L: 2243-3376

ISSN: 2243-3376

**Lappeenranta University of Technology Research Reports 91. ISSN: 2243-3376
Lappeenranta 2019**

Acknowledgements

The authors gratefully acknowledge the financial support of the German Federal Environmental Foundation (DBU) and Stiftung Mercator, which made this study possible. The authors would like to acknowledge Werner Zittel and the Ludwig Bölkow Foundation, the umbrella organisation of the Energy Watch Group, the Haleakala Foundation and personally Paul Grunow, as well as DWR eco GmbH and in particular David Wortmann and Doreen Rietentiet.

The development of the LUT Energy System Transition model and the collection of global datasets required enormous financial resources, which were provided by Tekes (Finnish Funding Agency for Technology and Innovation) for the 'Neo-Carbon Energy' project (40101/14) and the 'Finnish Solar Revolution' project (880/31/2016). We also appreciate the support from LUT University and several foundations, in particular, the LUT Foundation, Reiner Lemoine Foundation and Fortum Foundation.

The high passion of current and former team members of scientific coordinator, Christian Breyer, contributed to the milestones achieved by this study. They include Alla Toktarova, Svetlana Afanasyeva, Maulidi Barasa, Marzella Görig, Solomon A. Asfaw, Narges Ghorbani, Abdelrahman Azzuni, Alena Poleva, Otto Koskinen, Dominik Keiner, Peter Greim, Stephen Horvath, Eetu Rantanen Markus Hlusiak, Lotta Gruber, Guido Pleßmann, Chris Werner, Ann-Katrin Gerlach, Alexander Gerlach, and more, in particular Pasi Vainikka, Jero Ahola, Olli Pyrhönen and Jarmo Partanen.

The authors would also like to thank the remaining team of the Energy Watch Group for valuable comments, project management, communications, overall support and untiring dedication, especially: Charlotte Hornung, Erica Johnson, Komila Nabiyeveva and Siglinde Svilengatyin.

Thanks to all those involved, and congratulations for achieving these new scientific insights. Together, we have now built the foundation for the necessary transition towards a global energy system based on 100% renewables.

To Greta Thunberg and to the whole #FridaysForFuture movement,
for your relentless courage for the preservation of our planet,
and a better future for us all.

Foreword

The ongoing Fridays For Future movement initiated by young climate activist Greta Thunberg shall serve as a wake-up call for all of us to collectively do our best to hand over our planet to the next generation in the best condition possible. We need to radically change the status quo in which we have put our planet and our children; threatened by the challenges of climate change, air pollution, nuclear threats, conflicts over resources, poverty and refugee crises. With the scientific findings and elaborated set of policy measures of this study, we have developed a roadmap to achieve what our young generation calls for with great dedication and courage.

This research, jointly undertaken by Finland's LUT University and the Energy Watch Group, does not only add one more study about climate-benign future energy systems, but rigorously opens up a new perspective towards a shift to 100% renewable energy within the next two to three decades. It features a cost-efficient vision of a deep electrification of the heat and transport sectors around the globe based on a detailed assessment of spatially highly resolved renewable energy potentials that are domestically available in hourly resolution of a full year. The outlined global transition pathway stands out as the first to present a 1.5°C scenario that is technology-rich, multi-sectoral, multi-regional and cost-optimal. Notably, it achieves a cost decline without the reliance on high-risk technologies such as nuclear power and carbon capture and sequestration (CCS). A full energy transition to 100% renewable energy is not only feasible, but also cheaper than the current global energy system.

The study was set up with the belief that rapid and effective climate protection is the only way to save a planet worth living on for generations to come. From the start of the project, the team was also fully conscious about the anachronism of saving parts of the old, centralised conventional energy system based on fossil and nuclear fuels. Instead, this project was set up to show how techno-economic facts open the door for a much faster and more rigorous shift to renewable energy sources in order to trigger an even more dynamic technology development worldwide, and in addition a chance for all world regions to gain energy independence and benefit from the associated prospects of peace and conflict resolution.

The global report marks the finalisation of an intensive, ground-breaking and very rewarding project, that was executed over a span of more than four and a half years and included several milestones such as the publication of the power sector study in 2017 and the presentation of the regional European chapter at COP24 in Katowice last December.

We need to change the conversation: A transition to a global 100% renewable energy system is no longer a matter of technical feasibility or economic viability, but one of political will. Not only do we need ambitious targets, but also stable, long-term, and reliable policy frameworks, adapted to regional conditions and environments. We call on the global community to urgently pursue a forward-looking pathway towards net zero GHG emissions by launching a rapid change of the way we use natural resources and provide electricity, heat and transport.

Hans-Josef Fell

A 100% Renewable Energy System is Cheaper than the Current Global Energy Supply Zero GHG Emissions from Power, Heat, Transport and Desalination Sectors is possible before 2050

KEY FINDINGS

A global transition to 100% renewable energy across all sectors – power, heat, transport and desalination before 2050 is feasible¹. Existing renewable energy potential and technologies, including storage, is capable of generating a secure energy supply at every hour throughout the year. The sustainable energy system is more efficient and cost effective than the existing system, which is based primarily on fossil fuels and nuclear. A global renewable transition is the only sustainable option for the energy sector, and is compatible with the internationally adopted Paris Agreement. The energy transition is not a question of technical feasibility or economic viability, but one of political will.

The state-of-the-art scientific modelling of the “Global Energy System based on 100% Renewable Energy – Power, Heat, Transport and Desalination Sectors” study simulates a transition to 100% renewable energy of the entire world, structured in nine major regions and 145 sub-regions on an hourly resolution of 5-year time periods from 2015 until 2050. The modelling computes the cost-optimal mix of technologies, based on locally available renewable energy sources.

By 2050, the world’s population is expected to grow from 7.2 billion in 2015 to 9.7 billion. Final energy demand is expected to grow by about 1.8% annually, driven by energy services for higher level of living standard, and is accompanied by massive energy efficiency gains.

Electrification and decentralisation lead to more efficiency

Electrification across all energy sectors is inevitable (see Figure KF-1) and is more resource efficient than the current system. Electricity generation in 2050 will exceed four to five times that of 2015, primarily due to high electrification rates of the transport and heat sectors. Final energy fuel consumption is reduced by more than 2/3 (68%) from 2015 numbers, as fossil fuels are phased out completely and remaining fuels are either electricity-based or biofuels. Electricity will constitute for more than 90% of the primary energy demand in 2050. This electrification results in massive energy efficiency gains when compared to a low electrification trajectory (see KF-1). Almost all of the renewable energy supply will come from local and regional generation.

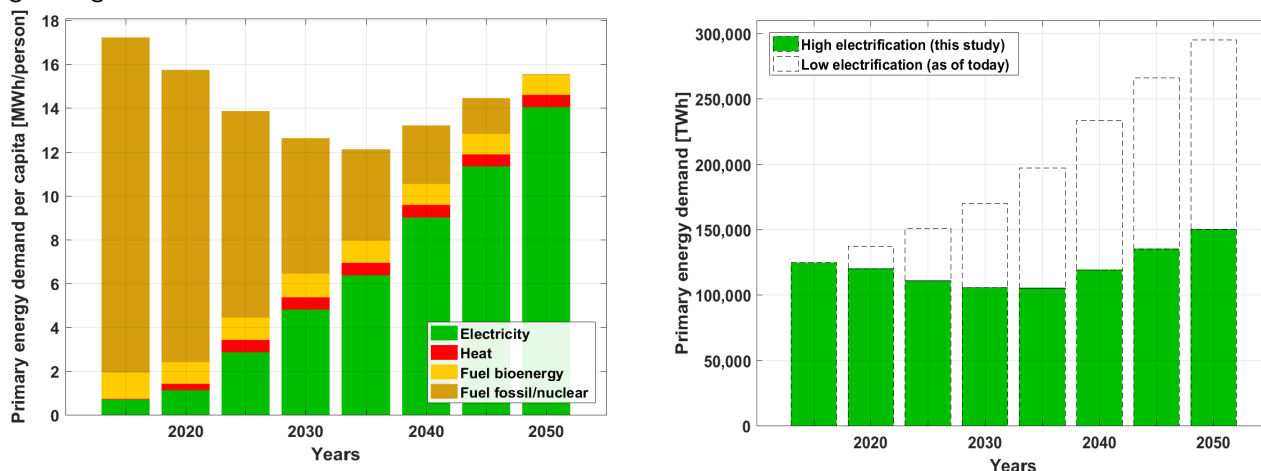

Figure KF-1: Primary energy demand per capita (left) and primary energy demand with high electrification and low electrification (right) through the transition.

¹ Energy transition simulations in this study are until 2050. However, with favourable political frameworks, the transition to 100% renewable energy can be realised well before 2050.

Solar PV and wind energy lead the transition

Primary energy supply in the 100% renewable energy system will be covered by a mix of sources, with solar PV generating 69%, followed by wind energy (18%), biomass and waste (6%), hydro (3%) and geothermal energy (2%) by 2050 (see Figure KF-2). Wind energy and solar PV make up 96% of total electricity, and approximately 88% of the total energy supply, which will have a synergetic balancing effect.

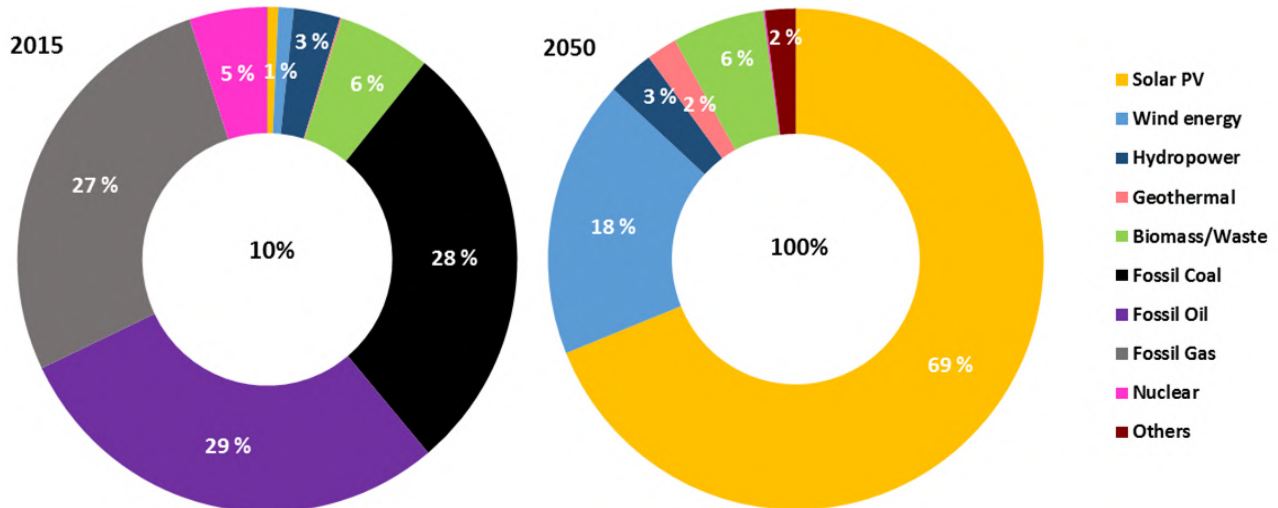

Figure KF-2: Shares of primary energy supply in 2015 and 2050.

100% renewable energy is cheaper than the current energy system.

- The levelised cost of energy for a fully sustainable global energy system will be slightly cheaper than for the current system, reducing from approximately 54 €/MWh in 2015 to 53 €/MWh by 2050 (see Figure KF-3). When taking into account negative externalities of the current system, which have been cited in numerous other contemporary studies, the 100% renewable global energy system is a substantially cheaper option.
- A 100% renewable energy system provides a win-win for the global community at large; with both economical and environmental benefits.
- Major regions can realise a substantial cost reduction including Middle East and North Africa (-31%), North America (-22%), South America (-34%), and Europe (-15%), while achieving zero emissions by 2050. The levelised cost of electricity decreases substantially from around 78 €/MWh in 2015 to around 53 €/MWh by 2050, while the levelised cost of heat increases from around 39 €/MWh in 2015 to around 49 €/MWh by 2050.
- It can be concluded from the results that the transition eliminates international energy dependencies and helps to solve energy-related conflicts.
- A trend develops where the levelised cost of energy becomes increasingly dominated by capital costs, as fuel costs lose importance through the transition period.
- Investments in the energy sector increase through the transition and are spread across a variety of technologies with major investments in solar PV, wind energy, batteries, heat pumps, and synthetic fuel conversion (see Figure KF-3).

The total annual transport energy costs decrease through the transition period from around 2.09 trillion euros in 2015 to about 1.9 trillion euros by 2050. Final transport passenger costs decline for road transport, whereas there is a marginal increase in costs for marine and aviation transport. Final transport freight costs decline in case of road, remain stable for rail and marine and increase slightly for aviation.

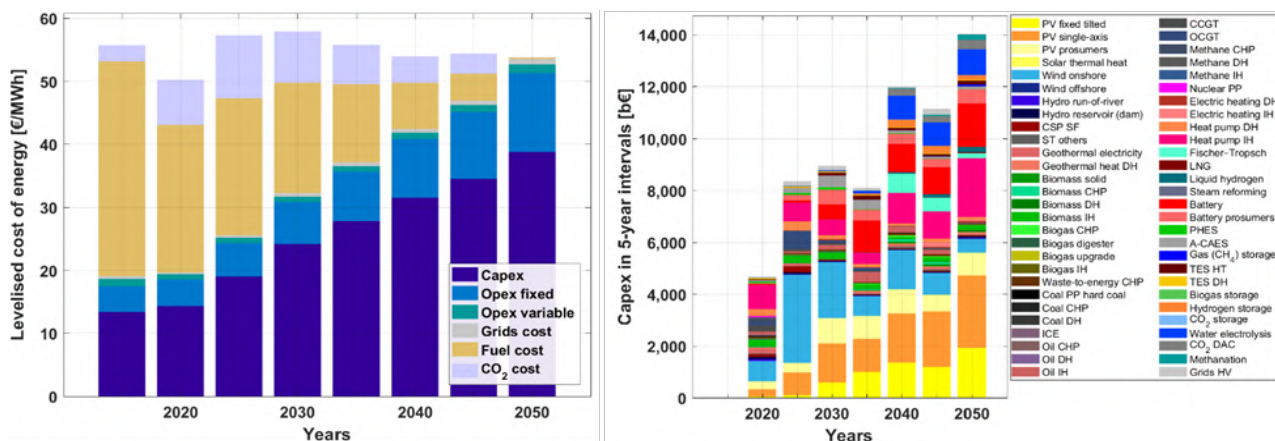

Figure KF-3: Levelised cost of energy (left) and investments in five-year intervals (right) during energy transition from 2015 to 2050.

Global energy-related greenhouse gas emissions can be reduced to zero by 2050, or sooner, across all energy sectors

- Annual global greenhouse gas (GHG) emissions in the energy sector decline steadily through the transition from approximately 30 GtCO_{2eq} in 2015 to zero by 2050 (see Figure KF-4). The remaining cumulative greenhouse gas emissions are approximately 422 GtCO_{2eq} from 2018 to 2050. Energy-related GHG emissions account for more than 60% of total global GHG emissions in 2015.
- In contrast to popular claims, a deep decarbonisation of the power and heat sectors is possible by 2030. The transport sector will lag behind, with a massive decline of greenhouse gas emissions from 2030 to 2050 (see Figure KF-4).

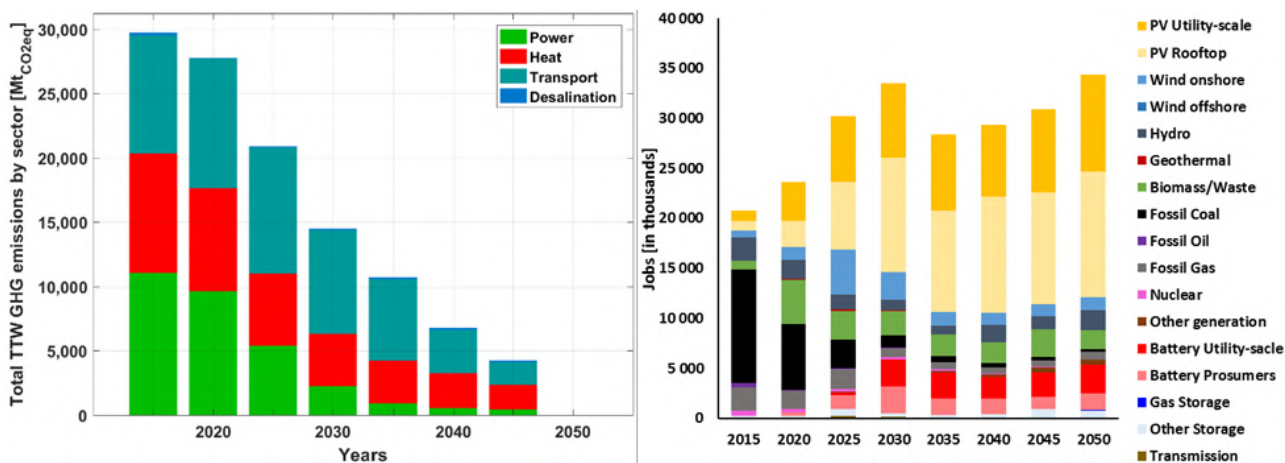

Figure KF-4: Total GHG emissions (left) and jobs in the power sector (right) during the energy transition from 2015 to 2050 worldwide.

A 100% global renewable energy system will support millions of local jobs in the power sector

- In 2015, the global power sector employed approximately 20 million people, with more than 70% in the fossil fuel sector (see Figure KF-4).
- A 100% renewable power system will employ 35 million people and solar PV emerges as the major job creating industry, employing more than 22 million by 2050, followed by battery, biomass, hydro and wind industries.
- The approximate 9 million jobs in the global coal industry of 2015 will be reduced to nearly zero by 2050 and will be overcompensated by more than 15 million new jobs in the renewable energy sector.

Global renewable energy generation and storage capacities will improve efficiencies and create energy independence

- Approximately 96% of renewable electricity generation will come from solar and wind energy by 2050, and with a significant amount of local generation, the system will be more efficient.
- Energy storage will meet nearly 23% of electricity demand and approximately 26% of heat demand. Batteries will emerge as the most relevant electricity storage technology and thermal energy storage emerges as the most relevant heat storage technology by 2050.

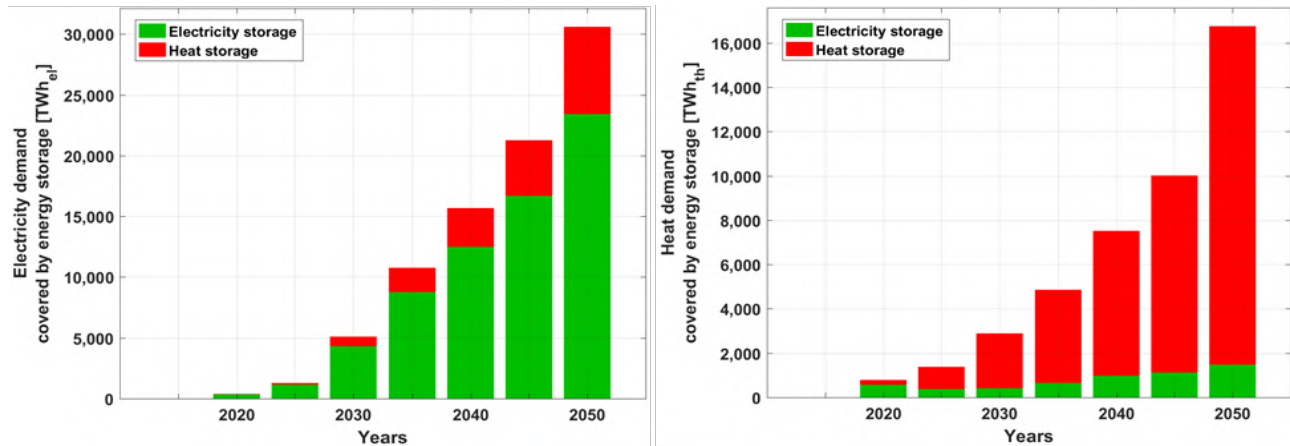

Figure KF-5: Electricity demand covered by energy storage (left) and heat demand covered by energy storage (right) during the transition from 2015 to 2050 worldwide.

Sustainable biofuels and natural carbon sinks will offset emissions

- Biofuels will be produced only in a sustainable way on degraded lands. Globally, around 6.7 million km² of degraded arid lands are available, on which 263 million tons of sustainable Jatropha plant oil could be harvested up to 2050. The potential to offset emissions range from 1 to 15 tCO₂/(ha·a). Up to 10 gigatons of annual natural carbon sinks might be created on jatropha basis on degraded land.

Desalination

- By 2050, water desalination will be nearly 40 times the amount of 2015. This will require substantial desalination capacities and some water storage. Desalination will account for approximately 4% of total primary energy demand in 2050, which can be fully met with renewables.
- Eurasia, the Middle East and North Africa, SAARC with India, Northeast Asia and North America will demand 91% of the global energy used for desalination. Europe, Southeast Asia, Sub-Saharan Africa, and South America share just 9%.

Regional differences in electricity supply

- The energy transition will have some key regional renewable energy generation differences (see Figure KF-6). Almost all Sun Belt countries will use solar PV as their primary source of electricity.
- South Asia (SAARC)² has a world record share of 95% solar PV electricity generation by 2050 in its cost-effective generation mix.
- In Eurasia, onshore wind dominates electricity generation, with the highest shares worldwide. Onshore wind ranges from 61% in 2025 to 47% in 2050, with solar PV generation only gradually increasing towards 2050.
- Few regions have a diversified mix of renewables with solar PV, wind energy, and hydropower in their energy supply, such as: the Nordic region, Western Eurasia, Central China, Chile, and New Zealand.
- By 2025, North America is set to have approximately 25% of the global wind energy provision. Towards 2050, the costs of electricity provision in North America can be reduced by more than a third. The transition will be accompanied by an increase in jobs from around 1.8 million to about 2.7 million by 2050.
- The diverse range of energy systems is induced by locally available resources, which enhances energy security around the world; this could lead to a more peaceful and prosperous global community.

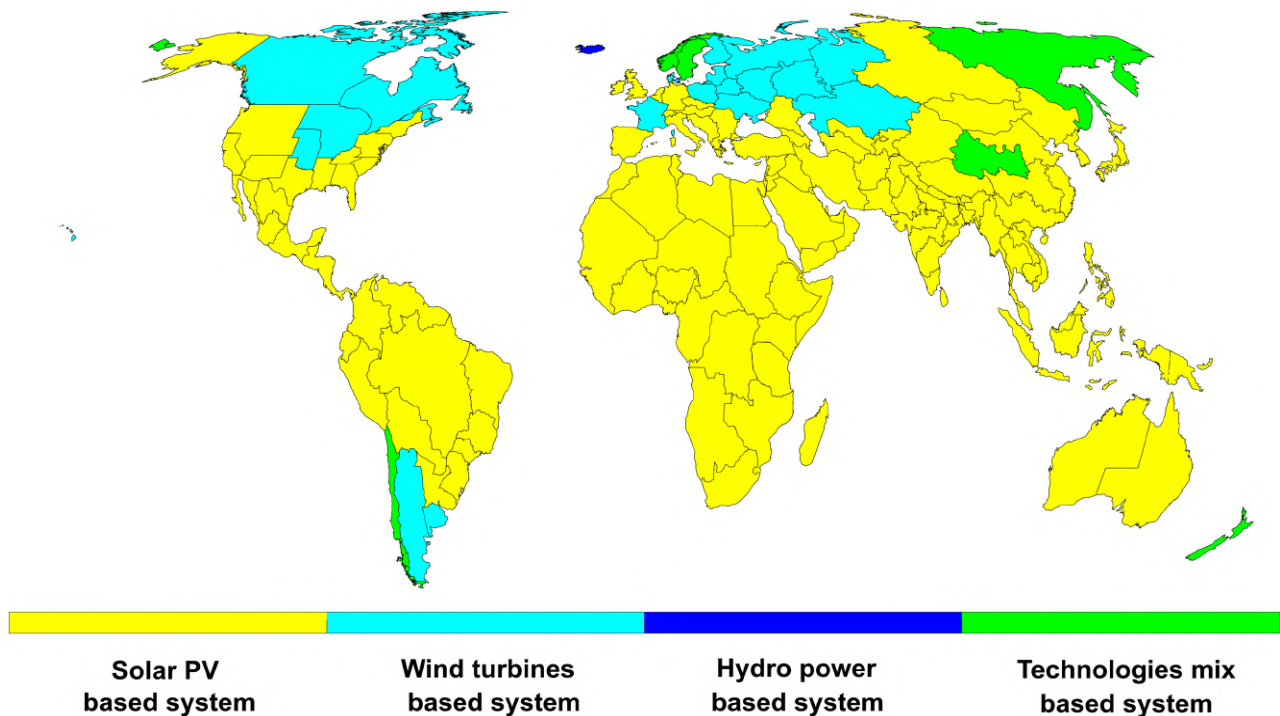

Figure KF-6: Main types of 100% renewable electricity systems.

² Countries of the South Asian Association for Regional Cooperation

Policy Recommendations

To ensure a smooth, fast, and cost-effective transition to 100% renewable energy across all sectors, governments need to adopt national legislative acts that will ensure the swift uptake in the development of renewable energy, storage technologies, sector coupling, and smart energy systems. Frameworks should include favourable investment conditions for all actors, including businesses and communities. The following key political support measures will accelerate the energy transition:

- Policies and instruments focused on sector coupling and enabling direct private investment in renewable energy and other zero emission technologies.
- Feed-in Tariff laws should be adopted to enable investments (under 40 MW) from decentralised actors, such as small and medium enterprises, cooperatives, communities, farmers and citizens. Tendering procedures for large scale investors should only be applied for utility-scale capacities above 40 MW.
- A responsible phase-out of all state subsidies to fossil fuel and nuclear energy generation is necessary.
- Introduction of carbon, methane and radioactivity taxes.
- Incentives created to spur the growth of renewable energy technologies; such as tax exemptions, direct subsidies, and legal privileges.
- Policies and frameworks that promote research, education and information sharing on renewable energy and zero emission technologies.

Executive Summary

Climate change is impacting every continent on Earth at increasing intervals. The detrimental impacts of climate change are projected to get much worse at a temperature rise of 2°C above pre-industrial levels. Limiting global warming to 1.5°C by mid-century could reduce the exposure to both climate-related risks and the corresponding susceptibility to economic burdens. Rapid and fundamental change is required across all carbon emitting sectors of the global economy, most particularly in the energy sector, which is the primary contributor to greenhouse gas (GHG) emissions. There is an urgent need for the global community to collectively pursue a pathway towards net zero GHG emissions by launching a rapid transition of the energy sector. There are still many countries and regions that have yet to initiate plans which will align their short-term actions and long-term energy goals with the degree of ambition that is required to realise the objectives of the Paris Agreement.

This research study undertaken by Finland's LUT University (LUT) and the Energy Watch Group (EWG) presents a first of its kind technology-rich, multi-sectoral, multi-regional and cost-optimal global energy transition pathway. Led by Dr. Christian Breyer, a group of 14 of the world's leading energy transition scientists conducted the study over a period of four and a half years. Using LUT's state-of-the-art energy transition modelling simulation, full hourly geo-spatial resolutions were used to compute the cost-optimal mix of technologies based on local available renewable

energy sources. The research conducted in this study provides cost optimised simulations of energy systems for 145 global regions, the study has been aggregated into nine major world regions. The study is a techno-economic blueprint demonstrating the least-cost and feasible energy mix with the transitioning of the global power, heat, transport and desalination sectors to net zero GHG emissions by 2050.

The study showcases that a global 100% renewable energy system can be achieved with zero GHG emissions before 2050 and more cost-effectively than the current fossil fuel and nuclear-based energy system. Solar photovoltaics (PV) and wind energy emerge as the new workhorses of the future global energy system. Solar PV emerges as the most prominent electricity supply source accounting for approximately 69% of the total energy supply by 2050, complemented by wind energy at 18%, hydropower at 3% and bioenergy at 6%. This translates to a total installed capacity of approximately 63,400 gigawatts of solar PV and 8,000 gigawatts of wind energy across the world by 2050. PV prosumers will drive a more decentralised energy transition across the different regions of the world, contributing to approximately 19% of electricity generation. Low-cost renewable energy supply enables electrification across the power, heat, transport and desalination sectors. A 100% renewable energy system is more efficient and cost competitive than the current fossil fuel and nuclear power based system.

Energy Demand

A fundamental shift in the energy sector is shaping the energy transition, which is currently predominantly based on fossil fuels. As indicated in Figure ES-1, electrification across the energy sector, comprising of power, heat, transport and desalination results in a primary energy share of

90% renewable electricity by 2050 and zero fossil fuels. This is a complete shift from the primary energy supply of the 2015 energy system, which depended primarily on fossil fuels (89%) and just 4% electricity from renewables.

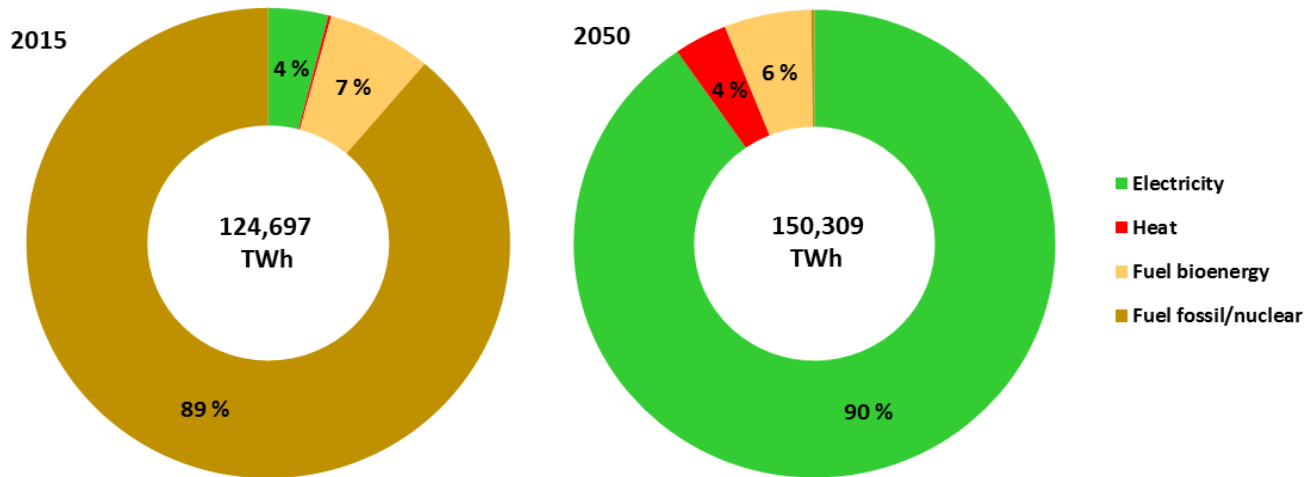

Figure ES-1: Shares of main fuels in the total primary energy demand globally, in 2015 and 2050.

A global cumulative average annual growth rate of approximately 1.8% in final energy demand triggers the transition (see Figure ES-2). This is driven by a growth in demand for energy-related services including power and heat, desalinated water and transportation, and additionally, by more energy efficient conversion and demand side technologies. The comprehensive electrification massively increases overall energy efficiency, which implies an even higher growth rate in provided energy services. The primary energy demand

decreases from roughly 125,000 TWh in 2015 to nearly 105,000 TWh by 2035 and increases to over 150,000 TWh by 2050. By comparison, current practices and low electrification would result in a primary energy demand of nearly 300,000 TWh by 2050 (see Figure ES-2). This massive gain in energy efficiency is primarily due to the high level of electrification of around 90% of primary energy demand, and will save nearly 150,000 TWh compared to the continuation of current practices with low shares of electrification.

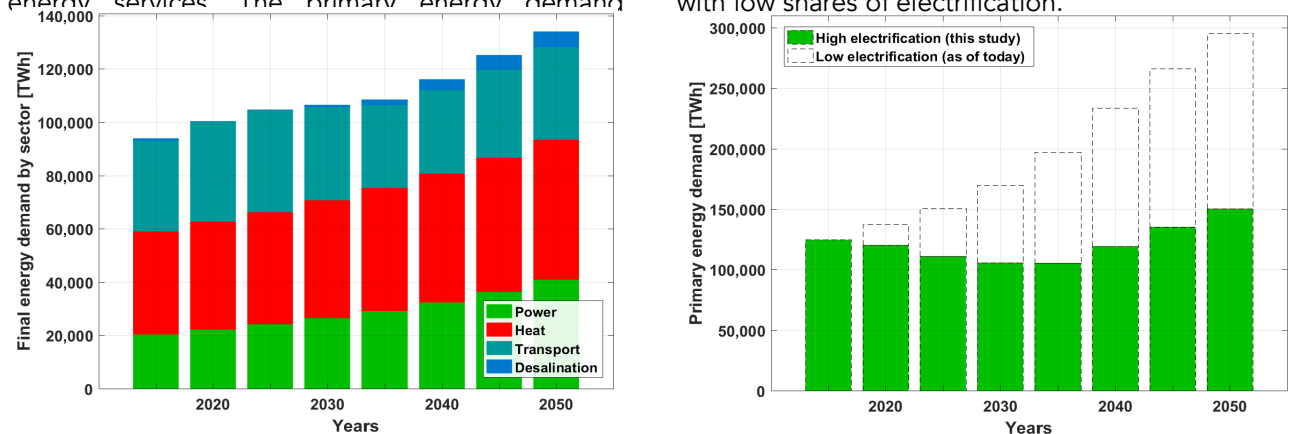

Figure ES-2: Sectoral final energy demand through the transition (left) and primary energy demand with high electrification and low electrification through the transition (right).

Primary Energy Supply

As the primary energy supply increasingly shifts toward electricity, correspondingly, the share of renewable energy increases from around 10% in 2015 to 100% by 2050. Solar PV and wind energy emerge as the most prominent electricity supply sources with approximately 76% and 20%, respectively, of the total primary electricity supply by 2050 across the power, heat, transport and

desalination sectors (see Figure ES-3). Solar PV is comprised of prosumer rooftop PV, fixed-tilted and single-axis tracking PV power plants. Additionally, hydropower contributes to around 3%, biomass 6%, and geothermal energy 2% and a further 2% by other renewables contribute to the lowest cost energy mix in 2050.

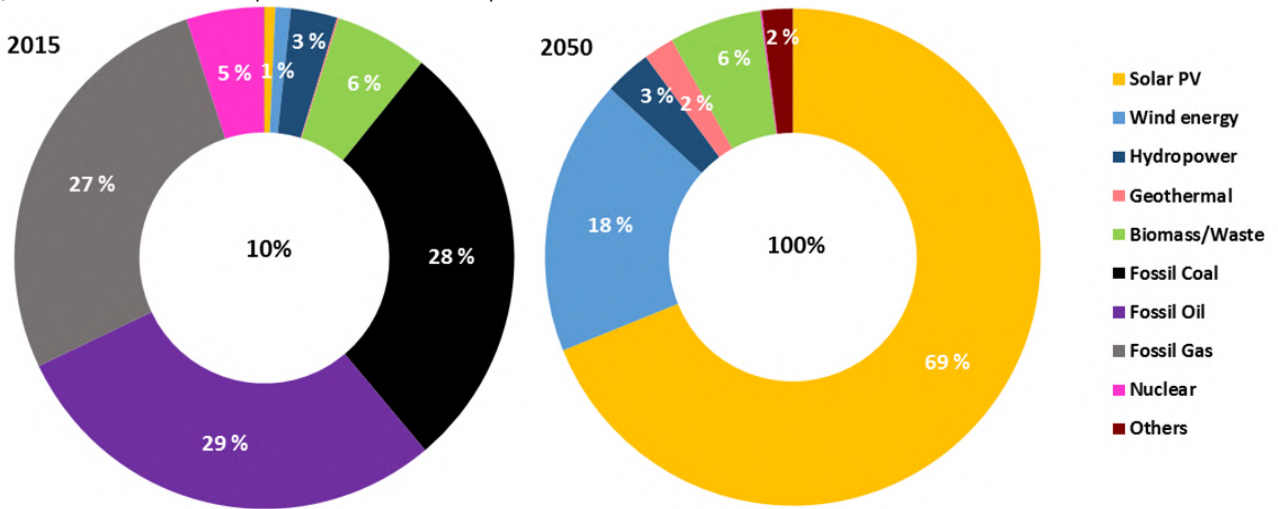

Figure ES-3: Shares of primary energy supply in 2015 and 2050.

Heat Supply

The heat supply shifts from being dominated by 85% fossil fuels in 2015, towards 100% renewable energy sourcing in 2050. Heat pumps play a significant role accounting for an approximate 44% share, followed by direct electric heating at 26%, and biomass-based heat accounting for 12% of the

mix (see Figure ES-4). Additionally, renewables-based gas provides around 12% of heat supply in 2050. Gas as a fuel shifts from extracted fossil fuels towards synthetically produced gas by renewable electricity along with biomethane throughout the transition.

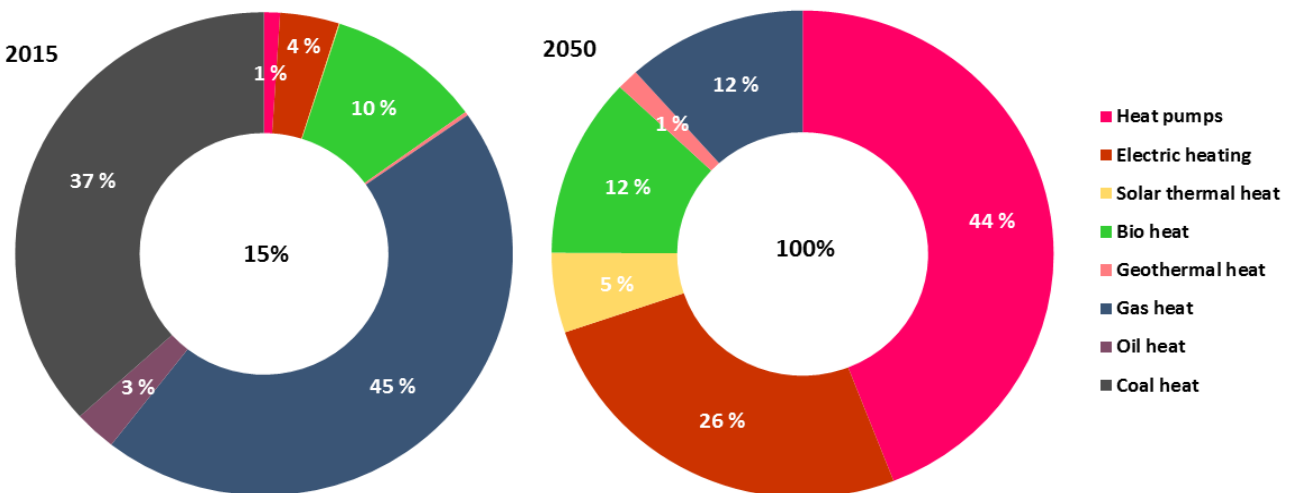

Figure ES-4: Shares of heat supply in 2015 and 2050.

Energy Storage

Energy storage plays a critical role in the transition of the global energy system toward 100% renewables. A combination of both electricity and

demand throughout the transition period (see Figure ES-5). Energy storage covers about 23% of the electricity demand and about 26% of heat

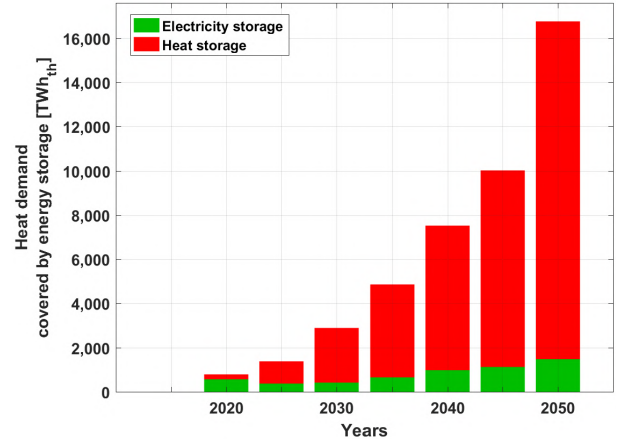
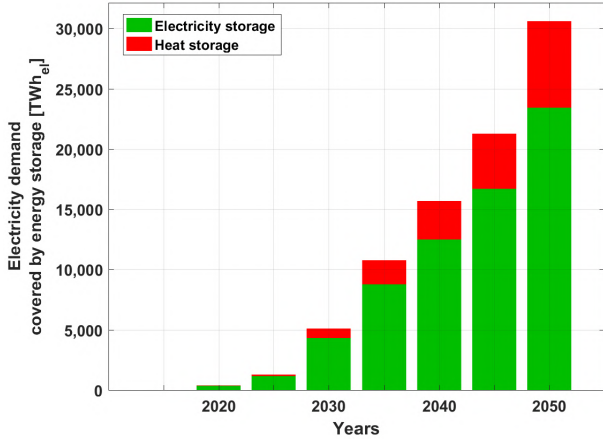

Figure ES-5: Energy Storage through the transition from 2015 to 2050 for electricity demand (left) and heat demand (right).

heat storage technologies cover the energy

demand in 2050.

Synthetic Fuel Production

A critical aspect to enabling a 100% renewable energy system is the production of synthetic fuels. Fuel conversion technologies such as Fischer-Tropsch, water electrolysis, methanation, and others supply renewables-based fuels through the energy transition. Along with sustainably produced biofuels, such as jatropha plantations on degraded land, electrification, and renewables-based synthetic fuels, ensure a 100% renewable energy-based transport sector across the different regions of the world. The corresponding capacities of fuel production technologies are phased-in predominantly beyond 2035 (see Figure ES-6).

Heat management plays a vital role in efficiently producing synthetic fuels. Recovered heat can provide a high share of the energy needed for CO₂ direct air capture, which in turn provides carbon from the atmosphere for the production of synthetic fuels. Utilisation of recovered heat and excess heat are vital for a cost optimal energy transition in the transport sector. This occurs significantly beyond 2035 (see Figure ES-6).

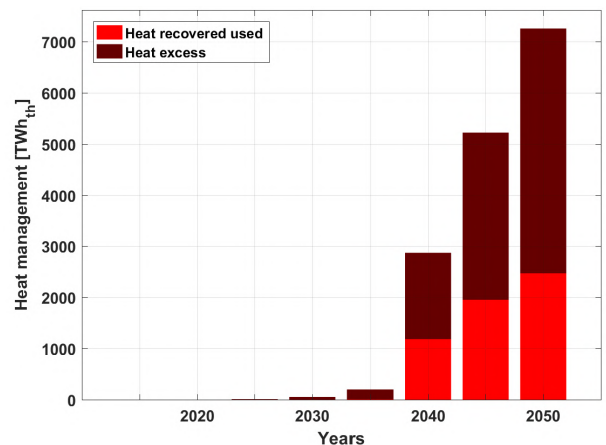
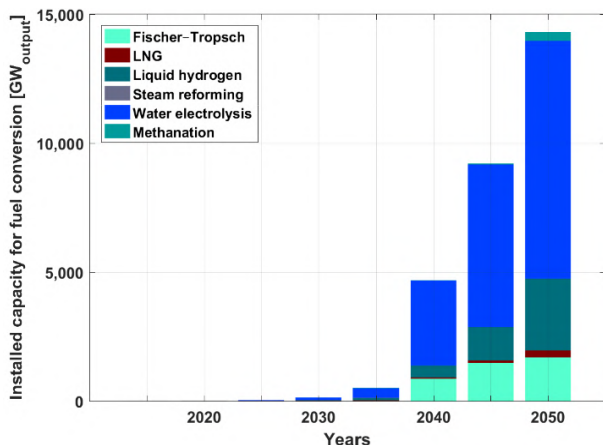

Figure ES-6: Installed capacities of fuel conversion technologies (left) and heat management (right) through the energy transition from 2015 to 2050.

Energy Costs and Investments

A shift to a 100% renewable energy sourced system results in a stable levelised cost of energy across the different regions of the world throughout the transition. The levelised cost of energy for a fully sustainable global energy system remains stable in the range of 50-57 €/MWh throughout the transition from 2015 to 2050 (see Figure ES-7). A trend develops where the levelised cost of energy shares become increasingly dominated by capital costs, as fuel costs lose significance through the transition period. There could be increased energy

diversification and local self-reliance across the different regions of the world by 2050.

Investments in the energy sector increase through the transition and are well spread across a range of technologies with major investments for solar PV, wind energy, batteries, heat pumps, and synthetic fuel conversion (see Figure ES-7). Investments are also well distributed across the three major sectors of power, heat and transport through 2050.

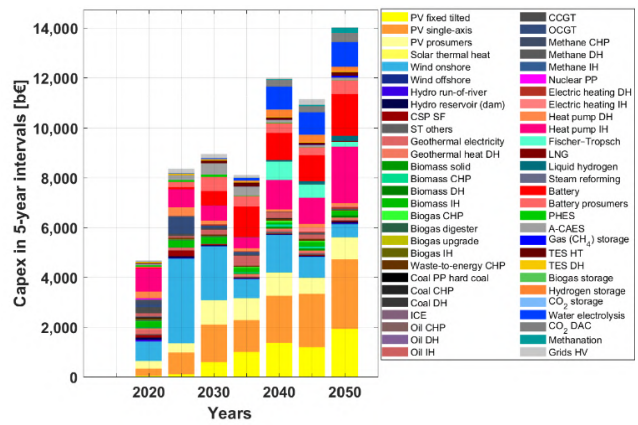
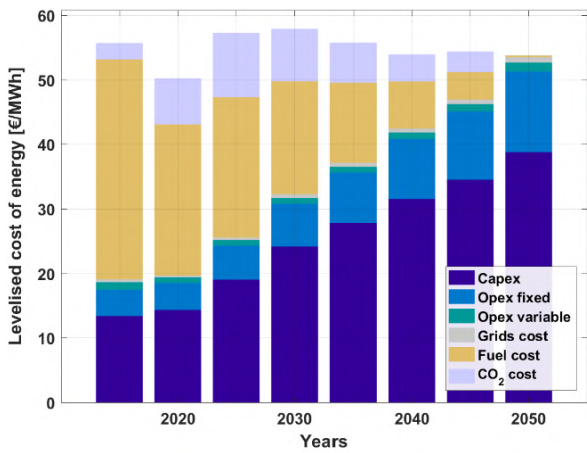

Figure ES-7: Levelised cost of energy (left) and investments in five-year intervals (right) through the energy transition from 2015 to 2050.

Emissions Reduction

The most important result of the global energy transition is that GHG emissions can be reduced from nearly 30,000 mega tonnes CO₂ equivalent (MtCO_{2eq}) in 2015 to zero by 2050 (see Figure ES-

8). The remaining cumulative GHG emissions of around 422 gigatonnes CO₂ equivalent (GtCO_{2eq}) are in adherence to the ambitious goals of the Paris Agreement of limiting temperature rise to 1.5°C.

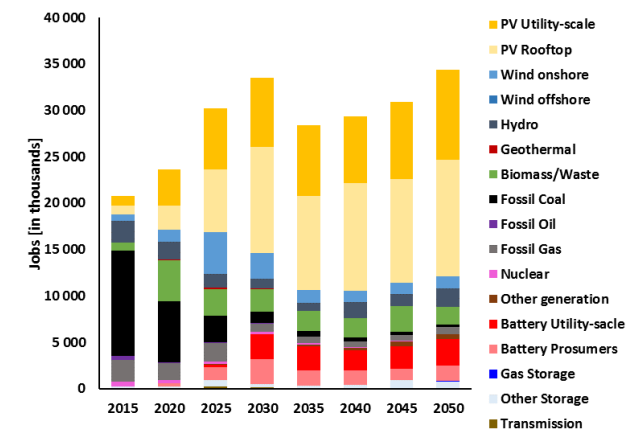
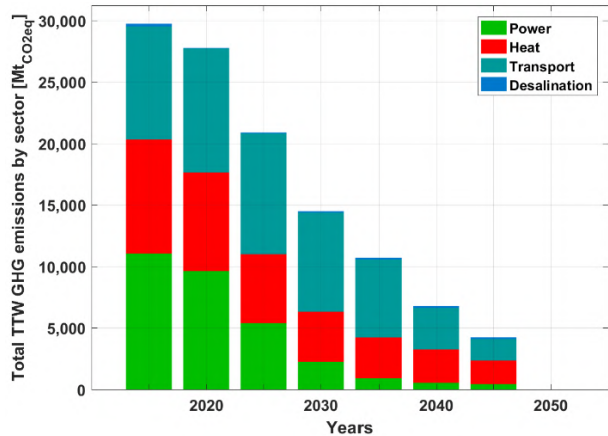

Figure ES-8: Sectoral GHG emissions (left) jobs created by different energy resources (right) through the energy transition from 2015 to 2050

Job Creation

Approximately 35 million direct energy jobs are created over the transition in the power sector across the different regions of the world (see Figure ES-8). Jobs shift from the fossil fuel sectors toward renewable energy and storage sectors, with solar

PV and batteries providing the majority of energy jobs by 2050. Jobs lost in the fossil fuel sectors are more than compensated with an additional 15 million jobs being created by 2050.

Policy Recommendations

To achieve a 100% renewable energy system, ambitious targets must be set and supported by stable, long-term, and reliable policies. Policy frameworks will need to be locally adapted to regional conditions and environments on the basis of subsidiarity. The energy transition can be spurred by:

- Feed-in policies, such as tariffs, guarantee a minimum price per unit of electricity. They stimulate local and regional, private and public, small-and medium-scale investments.
- Tendering procedures that are recommended for utility-scale projects with capacities above 40 MW. For projects below 40 MW of capacity, feed-in tariffs should apply to encourage distributed generation.
- Tax exemptions, direct subsidies, and legal privileges for renewable energy technologies.
- Introduction of carbon, methane, and radioactivity taxes.
- Regulation, mandates, and infrastructure planning that encourage heightened efficiency in buildings, lighting, electric appliances, electronic devices, and other energy loads.
- Co-generation (particularly bioenergy and power-to-gas) with full heat recovery.
- Levelling the playing field of energy supply through the removal of subsidies and by pricing negative externalities.
- An essential scaling-up of both public and private funding.
- Consistency of financial support from local, national, and regional governments.
- Divestment, investment, and setting up of new and innovative financing schemes.
- Creating stakeholder engagement across sectors to inclusively identify and take advantage of opportunities and eliminate barriers throughout the energy transition.
- Cooperative funding and share-based models combined with open and accessible online tools to monitor public expenditures (e.g. participatory budgeting schemes).

→ **Further sectoral and regional results of this global energy transition are presented in the report.**

Table of Contents

Foreword

Key Findings

Executive Summary

Table of Contents

1. Introduction	1
Status of the Global Energy Sector	1
Energy Transition Pathways	4
2. Transitioning to a fully Renewable Energy System: Methodology and Influencing Factors	6
LUT Energy System Transition Model	7
Data Preparation	8
Model Setup and Simulation	12
3. The Global Energy Transition: Regional and Sectoral Outlook	15
3.1. Global	15
Energy Supply	16
Energy Storage	18
Costs and Investments.....	19
Outlook across Sectors.....	20
Regional Outlook	31
3.2. Europe	39
Energy Supply	40
Energy Storage	41
Costs and Investments.....	42
Outlook across Sectors.....	43
Regional Outlook.....	52
3.3. Eurasia	60
Energy Supply	61
Energy Storage	62
Costs and Investments.....	63
Outlook across Sectors.....	64
Regional Outlook.....	73
3.4. Middle East and North Africa (MENA).....	80
Energy Supply	81
Energy Storage	82
Costs and Investments.....	83
Outlook across Sectors.....	84
Regional Outlook	93
3.5. Sub-Saharan Africa.....	101
Energy Supply	102
Energy Storage	103
Costs and Investments.....	104
Outlook across Sectors.....	105
Regional Outlook	114

3.6. South Asian Association for Regional Cooperation (SAARC).....	122
Energy Supply	123
Energy Storage	124
Costs and Investments.....	125
Outlook across Sectors.....	126
Regional Outlook	135
3.7. Northeast Asia	143
Energy Supply	144
Energy Storage	145
Costs and Investments.....	146
Outlook across Sectors.....	147
Regional Outlook	156
3.8. Southeast Asia and the Pacific Rim	162
Energy Supply	163
Energy Storage	164
Costs and Investments.....	165
Outlook across Sectors.....	166
Regional Outlook	175
3.9. North America.....	183
Energy Supply	184
Energy Storage	185
Costs and Investments.....	186
Outlook across Sectors.....	187
Regional Outlook	196
3.10. South America	201
Energy Supply	202
Energy Storage	203
Costs and Investments.....	204
Outlook across Sectors.....	205
Regional Outlook	214
4. Critical features of the Global 100% Renewable Energy System	222
Cost Optimal Energy Transition Pathway	222
Electrification of Energy Services	223
Synthetic Fuels	224
Local Resource Driven Energy Systems.....	226
Decentralisation	227
Biomass for Cooking	227
Prosumers – Power and Heat.....	228
A fair, inclusive and just Energy Transition	229
Future Research.....	230
Industrial Sector	232
Carbon Sinks and Negative CO ₂ Emission Technologies (NETs)	233
Cradle-to-cradle	233
5. Sustainable Jatropha Oil:	
Alternative Fuel for Semi-Arid Areas and Carbon Sink.....	234

6. Policy Recommendations	
towards a Rapid Transition to 100% Renewable Energy.....	238
6.1. Public & Government Support.....	238
General Approaches to Policy Making for the Energy Transition.....	238
6.2. Clear Legislative Frameworks	241
6.2.1. Rapid & Exponential Growth for Renewables.....	241
6.2.2. Phase-Out of Fossil and Nuclear Energy	246
6.3. Financial Instruments and Building New Institutions.....	247
6.3.1. Financing the Transition.....	247
6.3.2. New & Reformed Institutions as the Backbone of the Transition	248
6.4. Decentralisation of the Energy System.....	250
Benefits of Community Energy	250
7. Abbreviations.....	253
8. References	254
9. Appendix.....	263
Supplementary Data.....	263
Supplementary Presentations	264
A.1. Methodology	265
Power and Heat Sectors	265
Transport Sector.....	267
Industry Sector	267
Industrial Fuels Production	268
Desalination Sector	268
CO ₂ Removal Sector.....	269
Integrated System	270
A.2. Model description	270
Target Function.....	271
Energy Balance Constraints	272
Power and Heat Generation	273
Power and Heat storage.....	274
Power Transmission.....	275
Desalination	276
CO ₂ Removal.....	277
Transport and Fuel Production	277
Fuel Production for Transport.....	278
Biogas and Biomethane	278
PV Prosumers.....	278
A.3. Results preparation and cost calculations.....	279
Technical and Financial Assumptions.....	283

1. Introduction

Projections from the Intergovernmental Panel on Climate Change (IPCC)¹ has made it evident that a temperature rise of 2°C in comparison to pre-industrial levels would be far more devastating than previously expected both from the environmental and economic perspectives. Limiting warming to a rise of 1.5°C compared with pre-industrial levels will require cutting emissions by 45% by 2030 and reaching net zero around 2050¹. This means unprecedented efforts across the world and predominantly in the energy sector. Moreover, the United Nations has for the first time included energy in its new Sustainable Development Goals (SDG no. 7 - Ensure access to affordable, reliable, sustainable and modern energy for all), calling for a significant acceleration of renewable energy deployment². In this context, a transition of the global energy sector is of utmost relevance as the sector is responsible for the majority of global greenhouse gas (GHG) emissions. Defossilising all energy sectors and electrification of end-use along with smarter energy utilisation are essential components for a broader energy system transformation. The objective of this research conducted by the LUT University (LUT) and the Energy Watch Group (EWG) is to simulate and visualise a global energy system transition towards 100% renewables, in hourly resolution for the period 2015 until 2050 across the power, heat, transport, and desalination sectors, and to derive

recommendations for a supportive policy framework. The industrial sector is indirectly included regarding demand covered by the aforementioned sectors, except the non-energetic feedstock demand. Furthermore, the research has been conducted on a significantly high level of geo-spatial, technical and economic detail resulting in the most cost effective pathway to achieve a global energy system transition towards 100% renewable energy.

Status of the Global Energy Sector

As of 2016, modern renewables accounted for approximately 10.4% of total final energy demand (TFED), with the inclusion of traditional use of biomass the share was around 18.2%. Renewable electricity contributed the greatest portion of the new renewable technologies that accounted for 5.4% of TFED, most of which was generated by hydropower at 3.7%. Renewable thermal energy contributed an estimated 4.1% of TFED and biofuels for the transport sector about 0.9%. Traditional use of biomass, primarily for cooking and heating in developing countries, accounted for an additional 7.8%. Overall, the share of renewables grew by an estimated 0.25%, to around 19% of global TFED in 2017. All data are from REN21, (2018)³.

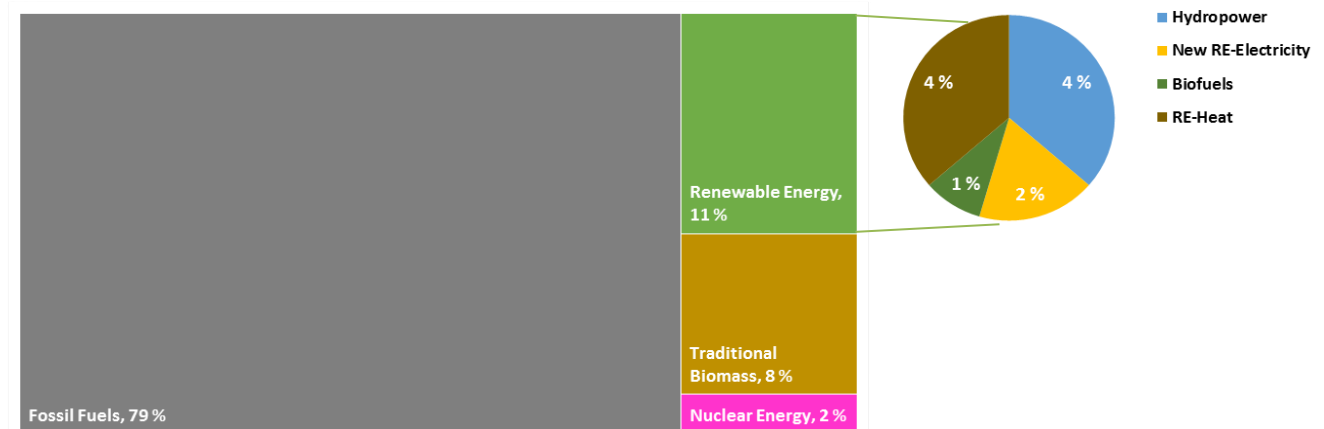

Figure 1-1: Shares of resources in the total final energy demand globally in 2017, adopted from REN21, (2018)³

Global renewable power capacity including hydropower has more than doubled since 2007, from around 1000 GW to about 2195 GW by the end of 2017³. The addition of renewable power capacities in the year 2017, of nearly 180 GW, are equivalent to 70% of all generation capacities added globally, the highest proportion in any year until now. Solar PV, accounting for nearly 55% of newly installed renewable power capacities, was

the most preferred investment technology in the power sector⁴. More solar PV capacity was installed in 2017 than the net installations of fossil fuels and nuclear power combined. (see Figure 1-2). In addition, renewable energy contributed around 27% of global electricity generation in 2017, of which wind energy and solar PV contributed around 8% as indicated in Figure 1-3.

Total Installed Renewable Energy Capacity - 2017

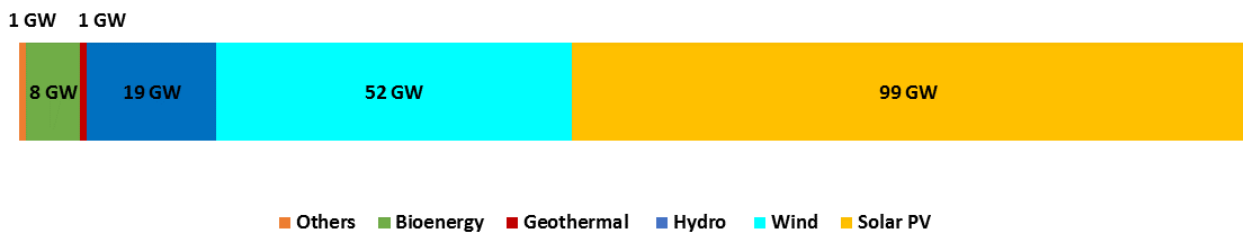

Figure 1-2: Global shares of annual renewable energy capacities installed in 2017, adopted from REN21, (2018)³.

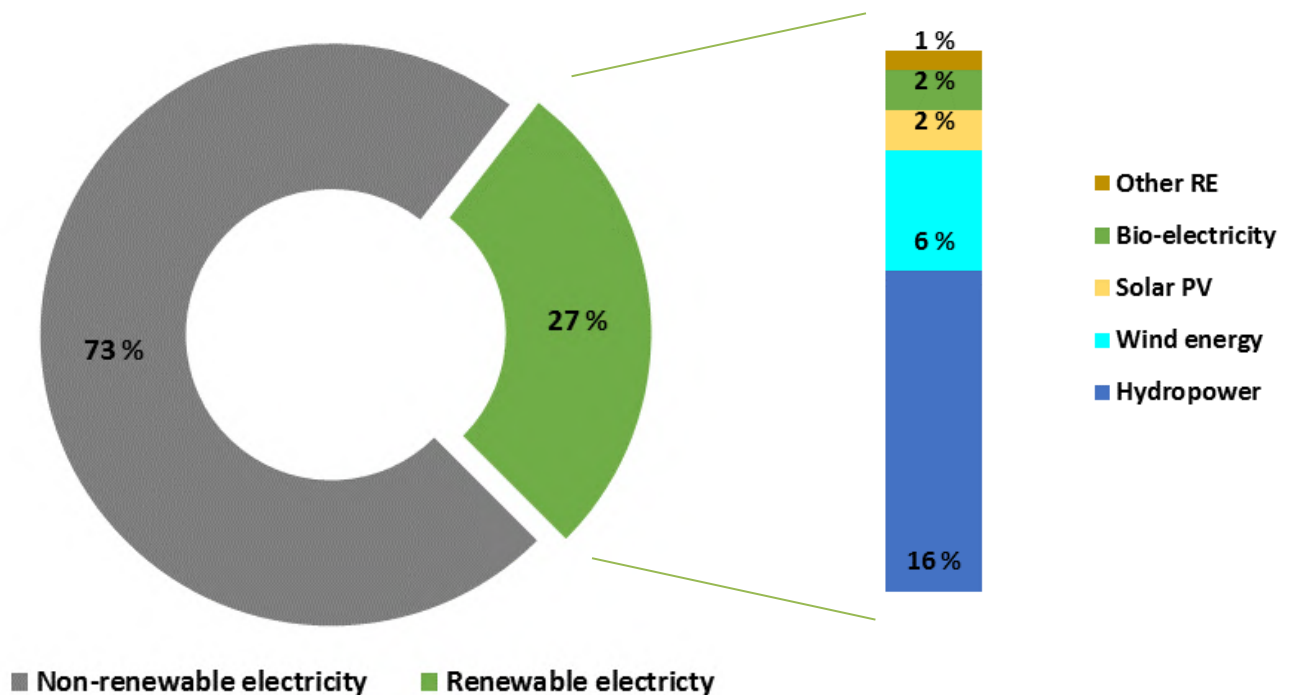

Figure 1-3: Global shares of annual electricity generation from renewable energy sources in 2017, adopted from REN21, (2018)³.

Despite the growth of renewables in the power sector, the remaining energy sectors are still lagging behind. The global heat consumption remains heavily based on fossil fuels. The largest share of renewable heating is associated with traditional biomass for heating and cooking in developing countries, which accounts for around

16.4% of global heat demand³, but causes major health burdens in particular for biomass-based cooking in developing countries. Only 10.3% of the heat used worldwide in 2015 was produced from new renewable energy technologies, including renewable electricity.

However, there is increasing application of renewables in various heating processes. Renewable energy can serve thermal demand when supplied by electricity, either directly or using heat pumps⁵. Furthermore, electrification of heating is on the rise, mainly using electricity from solar PV for heat to increase self-consumption rates in the face of reductions in feed-in tariffs and growing retail electricity prices⁶. District heat systems supply about 11% of global space and domestic hot water heating and are particularly suitable for use in densely populated regions that have an annual heating demand of four or more months, such as in the northern latitudes of Asia, Europe and North America³. In many regions in the world, renewable based district heating with seasonal storage is also a viable option⁵.

Energy for the transport sector makes up nearly one-third of global TFED⁷. The transport sector comprises several modes, namely road, rail, marine and aviation across passenger and freight categories⁸. Despite gains in efficiency, global energy demand in the transport sector increased 39% between 2000 and 2016, a rise attributed to the increased movement of freight globally and to the overall increase in transportation demand in emerging and developing countries, among other factors⁷. Currently, road transport accounts for 79% of global transport energy use, with passenger vehicles representing more than half of this. Additionally, marine transport consumes over 11% of the global energy used in transport, which is mainly from freight and is responsible for approximately 2% of CO₂ emissions. Moreover, aviation accounts for around 9% of the total energy used in transport, while rail accounts for less than 1% of the total energy used in transport and is the most electrified transport sector. However, there is a movement towards electrification in the transport sector with the evolution of the global electric car stock reaching nearly 2 million within six years from 2010 to 2016⁷. With more than 1.2 million electric vehicles sold in 2017 (or 1.5% of the global car market), the penetration of this technology in the transport sector could reach the same level as the PV penetration in the power sector, in the coming years and possibly evolve even faster⁴. The

cumulative global EV sales has reached 4 million in 2018 and the growth of EV sales is accelerating⁹. Likewise, the marine sector has options with increasing availability of alternative fuels such as biofuels in existing engines, which could be an immediate option, thereafter use of electricity-based synthetic fuels, such as synthetic natural gas, Fischer-Tropsch based fuels or hydrogen¹⁰. The production and use of sustainable aviation fuels, specifically bio-based jet fuel or synthetic jet fuel apart from direct electrification for short-distance flights can propel the aviation sector towards being more sustainable¹¹. Whereas, the rail sector with a share of electricity at 39% in 2015 is well underway for maximum electrification³. However, just one-fourth of the electricity is estimated to be renewable, contributing 9% of rail energy, which is expected to change along with the power sector. In addition, synthetic fuels, including hydrogen and biofuels could cover the non-electrified rail transport.

Energy for desalination is gaining importance globally, with growing levels of water stress across various regions. At the end of 2015, there were approximately 18,000 desalination plants worldwide, with a total installed production capacity of 86.55 million m³/day. Around 44% of this capacity (37.32 million m³/day) is located in the Middle East and North Africa¹². While desalination in that region is projected to grow continuously at a rate of 7 to 9% per year, the hot spots for accelerated desalination development over the next decade are expected to be in Asia, the USA and South America. Recent trends indicate that most of the new installations in desalination is electricity-based reverse osmosis. The integration of renewable energy resources in desalination and water purification is becoming economically even more viable as costs of conventional systems increase. Moreover, solar PV could provide a sustainable alternative to drive the desalination plants, especially in countries that lie in the Sun Belt, which is the region within 35° latitude above or below the equator with high solar irradiation. This includes countries in Africa and the Middle East, along with India and China¹³.

These recent trends across the different sectors show clearly that growth in renewable energy is on the rise. Nevertheless, current growth rates are insufficient to achieve the levels of defossilisation necessary by 2050 to limit warming to 1.5°C compared with pre-industrial levels. Significant additional electrification of the heat, transport, desalination and other energy sectors will be required. In this regard, rapid growth in renewable electricity must continue to accelerate the energy transition and pathways to make this possible have to be explored.

Energy Transition Pathways

Many global energy scenarios have tried to project the future transition of energy systems based on a wide ranging set of assumptions, methodologies and targets from a national as well as global perspective ¹⁴. The report from Centre for Alternative Technology ¹⁵ outlines scenarios at global, regional, national and sub-national scales that illustrate how the Paris Agreement targets could be realised. Moreover, conclusions are drawn from analyses of over 130 scenarios that demonstrate how deep decarbonisation or net-zero GHG emissions can be achieved before mid-century using prevailing technologies, whilst supporting social and economic development ¹⁵. Most of the studies lay out pathways to phase out non-sustainable technologies, such as nuclear energy and fossil fuel based energy conversion, while integrating sustainable renewable energy options to satisfy an increasing energy demand of the future global society. However, limitations of the methodology of global energy scenarios lead some of them to fail to acknowledge the role of storage technologies in future energy systems ¹⁴. Battery storage technologies that are currently experiencing trends similar to solar PV in terms of growth and cost reduction cannot be ignored much longer. Moreover, the increasing adoption of variable renewable energy and the opportunity for new flexible energy systems to be designed based on high shares of renewable generation eliminate the dependence on costly and less flexible traditional baseload generation ¹⁶. Furthermore, many studies are limited to the power sector and transitions across all energy sectors are yet to be explored in detail ¹⁷. Whereas, recent research

indicate that achieving 100% renewable energy and zero GHG emissions is possible, and most likely before the mid of this century ^{18,19,20,21,22,23,24}.

Current trends worldwide indicate that energy systems in this century will increasingly be based on electricity, mainly due to high technical efficiencies, comparably lower costs and the availability of prospective power-to-X technologies. These power-to-X technologies include power-to-heat (electric heat pumps ^{25,26}), power-to-water (reverse osmosis desalination ²⁷), power-to-hydrocarbons (hydrogen ^{28,29}, methanation ^{28,29,30,31}, synthetic fuels ^{31,32,33}, synthetic chemical feedstock ^{34,35,36,37}), a directly or indirectly electrified transport sector ⁸ (battery electric vehicles ^{38,39}, marine ^{40,41}, aviation ³²) and power-to-CO₂ for negative emission technologies ⁴², but also sustainable or non-avoidable carbon capture and utilisation (CCU) ⁴³. In consideration of these recent trends, decision-makers across the world increasingly seek out energy transition analyses on high geo-spatial and temporal resolutions along with technical and economic details. In this context, LUT University (LUT) and the Energy Watch Group (EWG) initiated this research to present an energy transition pathway encompassing all countries globally, which is required for a comprehensive societal discourse on national government levels, as well as for international institutions and companies. Research results for 100% renewable energy systems in hourly resolution across 145 regions of the world for the power sector have been previously made available by Breyer et al. ^{8,44} Bogdanov et al. ⁴⁵ and Ram et al ⁴⁶. However, this research presents for the first time a global energy transition towards 100% renewable energy and zero GHG emissions by 2050 in full hourly resolution, and for 145 regions in five-year time periods across the power, heat, transport and desalination sectors. It further demonstrates that 100% renewable energy can contribute to the utmost relevant societal requirement of achieving a zero-emission energy sector by 2050 globally, while energy costs remain stable.

This report presents an overview of the methodology (chapter 2), followed by the results for the energy transition across the various energy sectors globally, as well as in the nine major regions of the world (chapter 3). In addition, the economic perspectives of the energy transition globally as well as in major regions are presented and the socioeconomic benefits, such as job creation prospects and GHG emissions reduction potential of 100% renewable energy systems are showcased. Additionally, some of the critical aspects of this research are highlighted (chapter 4). Also, sustainable Jatropha oil as an alternative fuel

as well as a potential carbon sink is presented (chapter 5). Lastly, the report concludes with policy perspectives on enabling 100% renewable energy systems globally as well as locally (chapter 6).

A detailed documentation of the methodology and modelling aspects, along with the key technical and financial assumptions are presented in the Appendix. It also includes a link to a supplementary data file, which presents the key results of the global energy transition on a sectoral and regional basis.

2. Transitioning to a fully Renewable Energy System: Methodology and Influencing Factors

The transition to a fully renewable energy system has been carried out for the whole world, which is categorised into nine major regions. These nine major regions are further constituted by 145 sub-regions as shown in the Figure 2-1.

The corresponding countries in the nine major regions are enlisted in Table 2-1. Moreover, some of these countries (geographically large) are further divided into sub-regions, while some countries (geographically small) are aggregated to a single region. Therefore, resulting in an overall 145 sub-regions globally.

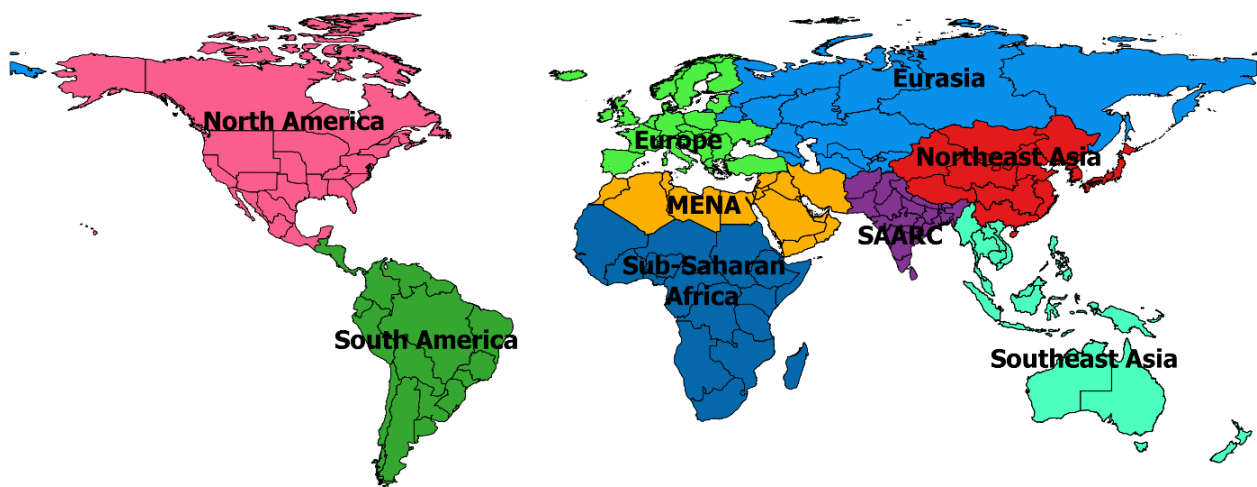

Table 2-1: The nine major regions and the corresponding countries imparted into the LUT Energy System Transition model.

Major Regions	Countries
Europe	Norway, Denmark, Sweden, Finland, Iceland, Estonia, Latvia, Lithuania, Poland, Portugal, Spain, Gibraltar, France, Monaco, Andorra, Belgium, Netherlands, Luxembourg, Ireland, United Kingdom, Isle of Man, Guernsey, Jersey, Germany, Czech Republic, Slovakia, Austria, Hungary, Slovenia, Croatia, Romania, Bulgaria, Greece, Bosnia and Herzegovina, Serbia, Montenegro, Macedonia, Albania, Italy, San Marino, Vatican, Switzerland, Liechtenstein, Turkey, Cyprus, Ukraine, Moldova
Euraisa	Russia, Belarus, Armenia, Azerbaijan, Georgia, Kazakhstan, Kyrgyzstan, Tajikistan, Uzbekistan, Turkmenistan
MENA	Algeria, Bahrain, Qatar, Egypt, Iran, Iraq, Israel, Jordan, West Bank and Gaza Strip as State of Palestine, Kuwait, Lebanon, Libya, Morocco, Oman, Saudi Arabia, Tunisia, United Arab Emirates, Yemen, Syria
Sub-Saharan Africa	Gambia, Cape Verde Islands, Guinea, Guinea Bissau, Liberia, Mali, Mauritania, Senegal, Sierra Leone, Benin, Burkina Faso, Cote d' Ivoire, Ghana, Togo, Chad, Niger, Nigeria, Sudan, Republic of South Sudan, Eritrea, Ethiopia, Somalia, Djibouti, Kenya, Uganda, Tanzania, Rwanda, Burundi, Cameroon, Central Africa Republic, Equatorial Guinea, Gabon, São Tomé and Príncipe, Congo Brazzaville, Congo, Angola, Botswana, Namibia, South Africa, Lesotho, Malawi, Mozambique, Swaziland, Zambia, Zimbabwe, Comoros Islands, Madagascar, Mayotte, Seychelles, Mauritius

SAARC	Afghanistan, Pakistan, India, Nepal, Bhutan, Bangladesh, Sri Lanka
Northeast Asia	China, Japan, Republic of Korea, Democratic People's Republic of Korea, Mongolia
Southeast Asia	Myanmar, Malaysia, Brunei, Singapore, Indonesia, Thailand, Laos, Vietnam, Cambodia, Philippines, Australia, New Zealand
North America	Canada, United States of America, Mexico
South America	Panama, Costa Rica, Nicaragua, Honduras, El Salvador, Guatemala, Belize, Colombia, Venezuela, Guyana, French Guiana, Suriname, Ecuador, Peru, Bolivia, Paraguay, Brazil, Argentina, Uruguay, Chile

Figure 2-1: The global map with the nine major regions constituted by the corresponding sub-regions.

LUT Energy System Transition Model

The LUT Energy System Transition model applied for the power sector in Ram et al., (2017) ⁴⁶, Bogdanov et al. ⁴⁵ and Breyer et al. ⁴⁴ is further expanded to other energy sectors and its fundamental aspects for application across various energy sectors as is shown in Figure 2-2. The unique feature of the model enables a global-local energy system transition towards 100% renewables

in hourly resolution for the transition period from 2015 until 2050 across the power, heat, transport, and desalination sectors. The results are visualised and presented in five-year intervals through the transition from 2015 to 2050 for the nine major regions across the world and further on aggregated into global results.

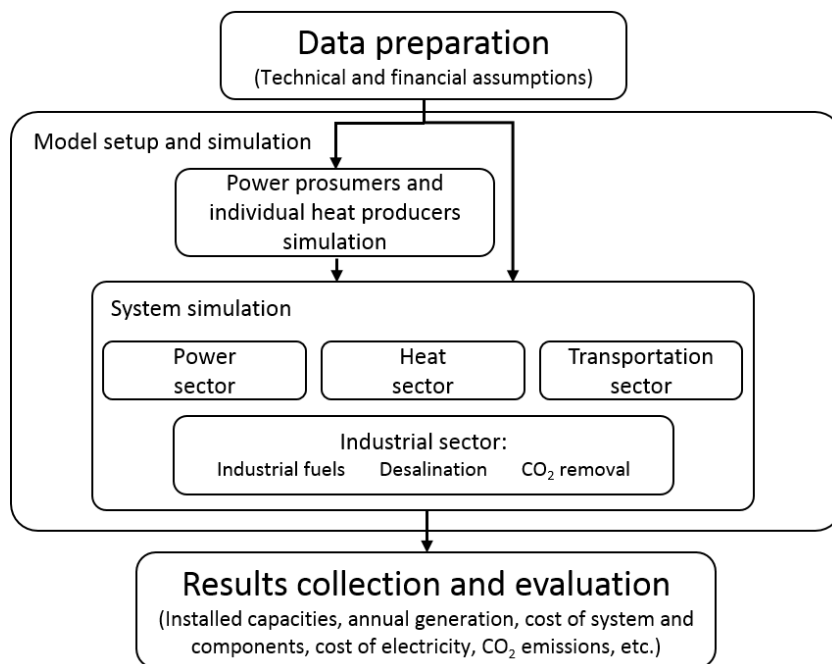

Figure 2-2: Fundamental structure of the LUT Energy System Transition model.

The Figure 2-2 shows a simple process flow of the tasks associated with utilising the LUT Energy System Transition modelling tool. As a first step, all relevant energy data across power, heat, transport and desalination sectors are collated into 145 sub-regions. This is further entered into the model for cost optimal simulations, which occur in 2 stages. Firstly, a prosumer optimisation is conducted to

determine the least cost energy options for prosumers across the world in 145 sub-regions. As cost optimal options for prosumers depend on annual energy cost savings in relation to local retail energy costs across the 145 sub-regions. The detailed prosumer methodology can be found in the Appendix.

The next stage involves an overall energy system simulation across the different sectors, wherein the power and heat sectors are integrated, while the transport and desalination sectors are individually simulated for the 145 sub-regions to derive cost optimal energy mixes for the years 2015 to 2050. This approach enables a more decentralised energy transition across the 145 sub-regions of the world that can satisfy their energy demands by

resources found within the corresponding sub-regions. Lastly, a post processing of the results involving analyses and visualisation is applied across the 145 sub-regions producing compiled results for the nine major regions, which is further aggregated into global results.

The various components of the modelling for this research study are further described.

Data Preparation

This includes determining long-term energy demand across the different sectors of power and heat, transport and desalination. In addition, it involves generating hourly demand profiles across all energy sectors, but also creating a global database of power plants across the world. Additionally, assessing the resource potentials of various renewable energy technologies across the different regions of the world is of importance. Furthermore, technical and financial details including assumptions, for all technologies are collated. All relevant data are organised across the 145 sub-regions through the transition period from 2015 to 2050, in five-year intervals.

Development of Energy Demand

The development of the energy demand across the sectors of power, heat, transport and desalination are estimated for the different regions of the world. The increasing demand for electrification of other sectors such as heat, transport and desalination is factored in, which results in a massive efficiency gain of primary energy over the final energy demand. The global final energy demand, which consists of electricity, heat and fuel, increases across the different sectors from around 95,000 TWh in 2015 to nearly 135,000 TWh by 2050, as shown in Figure 2-3.

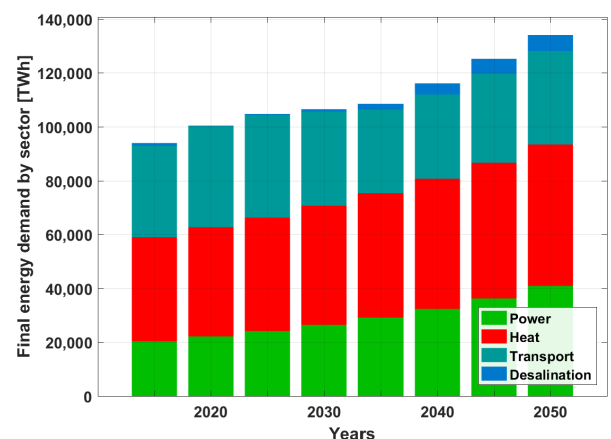
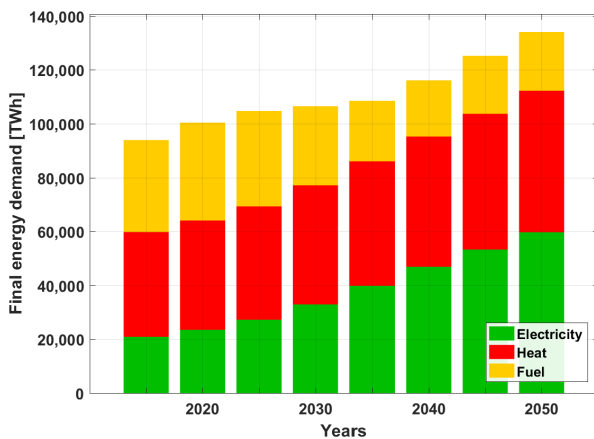

Figure 23: Development of final energy demand globally from 2015 to 2050, according to different forms of energy (left) and the different energy sectors (right).

The growth in electricity demand of the global power sector is estimated to represent a global average compound annual growth rate of 2.2% in the energy transition period, and is comparable to the assumption of 1.9% by the IEA ⁴⁷. Moreover, the demand profiles on an hourly basis for the different energy sectors based on regional variation were computed through the transition from 2015 to

2050, in five-year intervals. The synthetic electricity demand profiles from 2015 until 2050 are generated based on the methodology from Toktarova et al. ⁴⁸. The global electricity demand and synthetic load profile in 2020 are shown in Figure 2-4.

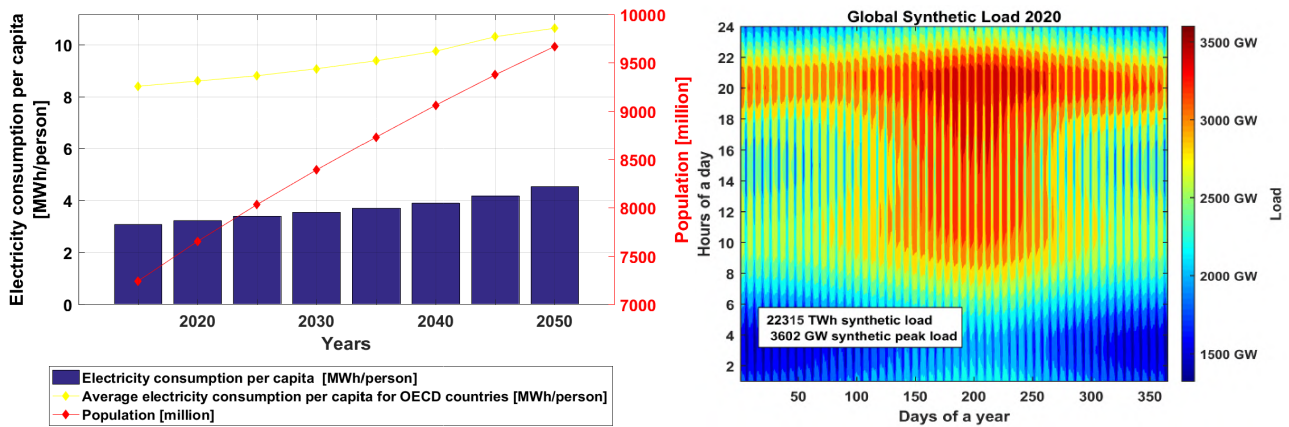

Figure 2-4: Development of average electricity consumption per capita globally and in OECD countries, growth in population from 2015 to 2050 (left) and the global synthetic load profile in 2050 (right) ⁴⁸.

Heat demand is categorised into space heating, domestic hot water heating, industrial process heat and biomass for cooking. Moreover, the heat is categorised as low temperature (LT), medium temperature (MT) and high temperature (HT) heat demand. Low temperature heat demand has the highest share through the transition, with minor shares of medium and high temperature heat demands. In addition, biomass-based cooking which is predominantly in least developed and

developing countries is expected to diminish almost fully by 2030, as people around the world are expected to get access to modern energy supply. The demand across the 145 sub-regions is collated through the transition period. The global heat demand on a sector-wise and operational basis is shown in Figure 2-5. It grows through the transition from around 38,000 TWh_{th} in 2015 to around 54,000 TWh_{th} in 2050.

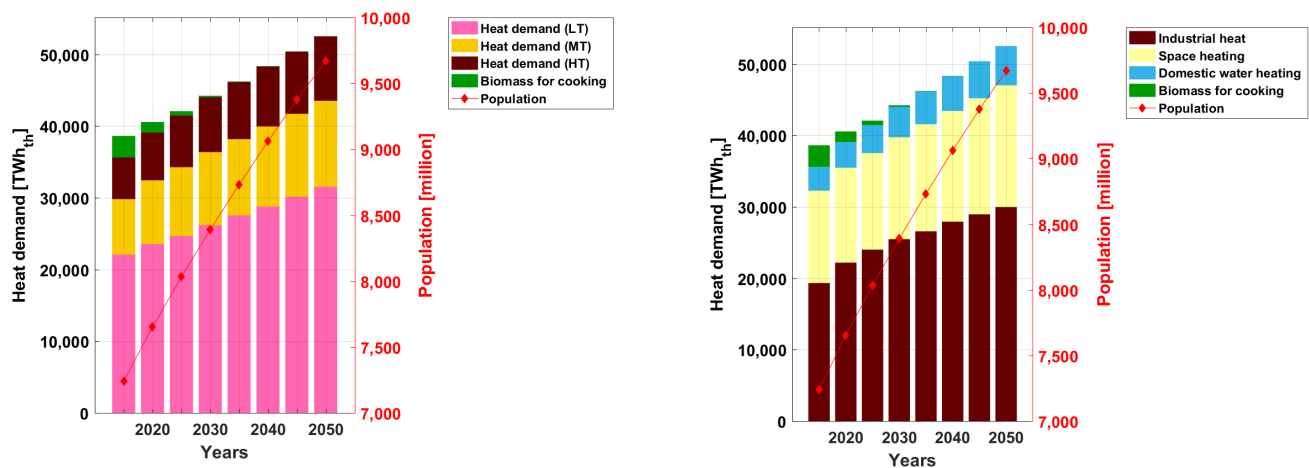

Figure 2-5: Development of heat demand globally category-wise (left) and application-wise (right) from 2015 to 2050.

Transportation demand is derived for the modes: road, rail, marine, and aviation for passenger and freight transportation. The road segment is subdivided into passenger light duty vehicles (LDV), passenger 2-wheelers/3-wheelers (2W/3W), passenger bus, freight medium duty vehicles (MDV), and freight heavy duty vehicles (HDV). The other transportation modes are comprised of

demand for freight and passengers. The demand is estimated in passenger kilometres (p-km) for passenger transportation and in (metric) ton kilometres (t-km) for freight transportation. The global final passenger demand and freight demand through the transition from 2015 to 2050 is shown in Figure 2-6.

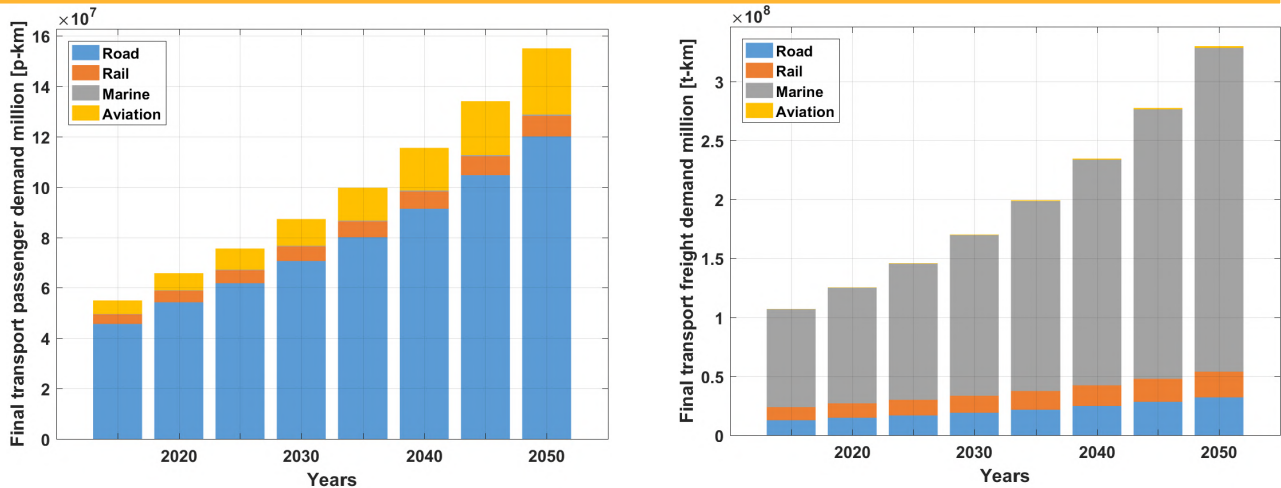

Figure 2-6: Development of global final transport passenger demand (left) and freight demand (right) from 2015 to 2050.

The corresponding final energy demand in the transport sector undergoes an increase and thereafter a decline and subsequent increase during the transition, from around 34,000 TWh in 2015 to below 35,000 TWh in 2050. The road transport energy demand declines through the transition with massive gains from high level of direct electrification, whereas the energy demand increases for marine and aviation in the last few years with higher level of energy demand from production of synthetic fuels. Energy demand for

the rail mode remains fairly stable through the transition, as it already has a high level of electrification. The development of energy demand for the different transport modes through the transition is shown in Figure 2-7. The low efficiency of the present transport sector is highlighted by the projection of a threefold increase in transportation demand, but stabilised final energy demand for the transport sector. More discussions, from a primary energy demand point of view, follow in the discussion of the results in chapter 3 and 4.

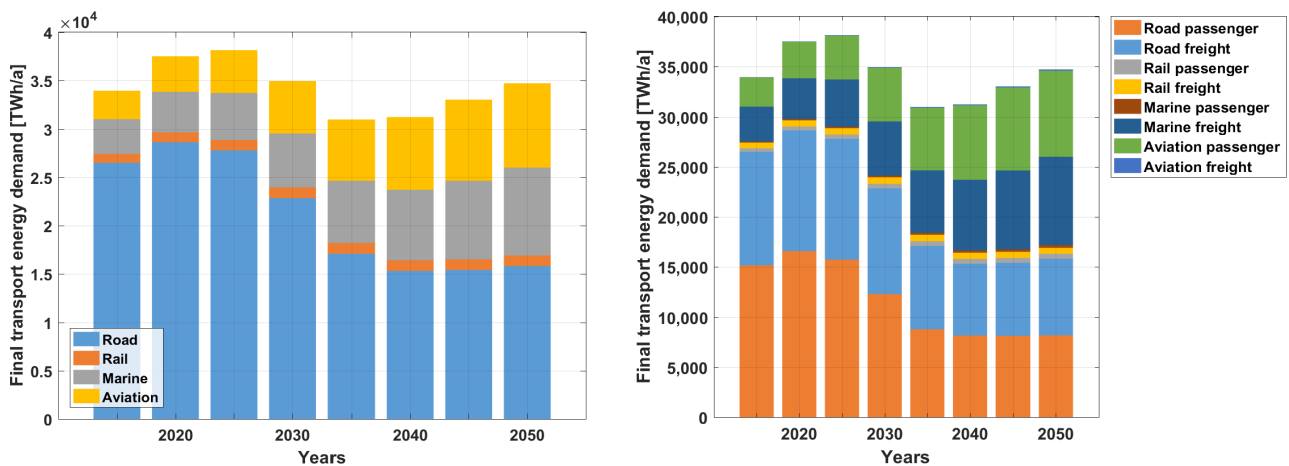

Figure 2-7: Development of global final transport energy demand based on transport mode (left) and passenger and freight of different modes (right) from 2015 to 2050.

The desalination demand is estimated for all regions with water stress greater than 40% and is a function of the water stress and total water demand for specific years as highlighted in Figure 2-8. This translates into energy demand for desalinated water. Currently, Seawater Reverse Osmosis

(SWRO) is becoming an important practical tool to deal with water scarcity in arid countries and to satisfy the growing water demand worldwide. Moreover, SWRO is expected to become widely adopted, mainly driven by diminishing unit production costs and increasing water prices ⁴⁹.

The total water demand is the sum of the projected demand from the municipal, industrial and agricultural sectors. Irrigated agriculture accounts for 70% of the global water withdrawals. However, the average global irrigation efficiency is estimated to be as low as 33% and experiences a maximum relative growth rate of 0.3% per annum. Therefore, the desalination demand presented in the report

addresses the demands of the municipal, industrial and agricultural sector with improved irrigation efficiency. The global demand for desalinated seawater and corresponding installed capacities of desalination technologies is shown in Figure 2-8.

A detailed description is available in the Appendix, and the energy demand across all sectors on a regional basis is presented in Table A7.

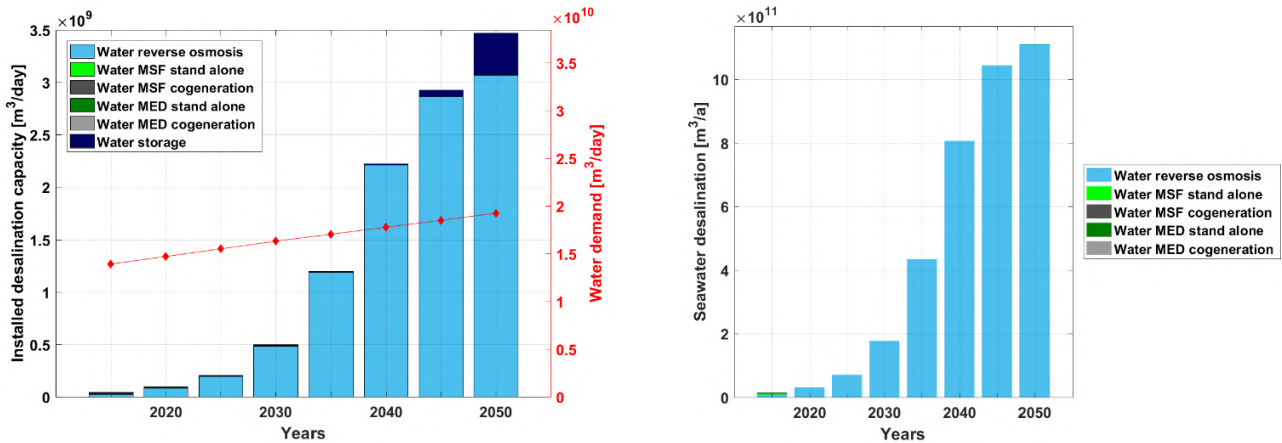

Figure 2-8: Development of global installed desalination capacity (left) and seawater desalination (right) from 2015 to 2050.

Global Power Plant Database

The global power plant capacities are structured according to the major technologies and their corresponding location in respective countries, along with the year of commissioning in an annual resolution⁵⁰. This facilitates proper accounting of power plant capacities that need to be phased out after reaching their end of technical lifetimes. This

is applied to all of the 145 sub-regions globally, in order to improve the accuracy of determining power capacity requirements during the transition period. Figure 2-9 shows the time-resolved installations of the global power plant capacities differentiated into the main electricity generation technologies.

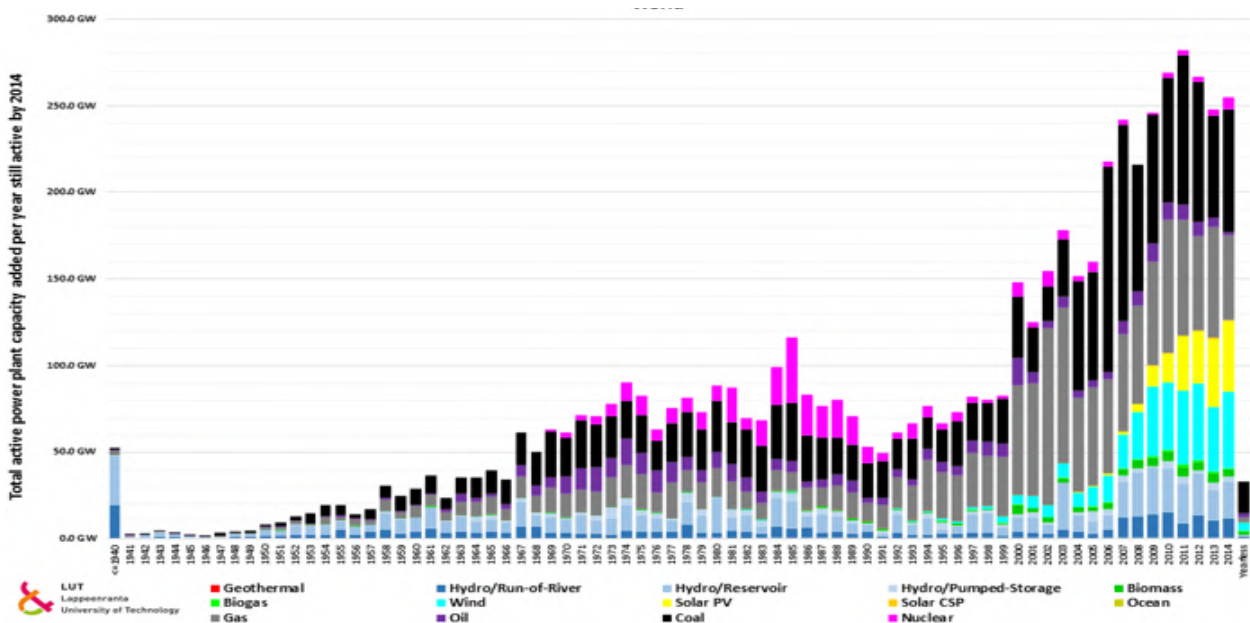

Figure 2-9: Historical power plant infrastructure development with annual installed capacities⁵⁰.

Resource Potential for Renewable Energy Technologies

The generation profiles for optimally fixed-tilted PV, solar CSP and wind energy are calculated according to Bogdanov and Breyer⁵¹ and for single-axis tracking PV according to Afanasyeva et al.⁵². The hydropower feed-in profiles are computed based on daily resolved water flow data for the year 2005⁵³. The potentials for biomass and waste resources were obtained from Bunzel et al.⁵⁴ and further classified into categories of solid wastes, solid residues and biogas. Geothermal energy potential is estimated according to the method described in Gulagi et al.⁵⁵. The global distribution of full load hours (equivalent to annual generation) of solar PV, for the case of single-axis tracking, and wind onshore at 150 m hub-height, which are the two most vital sources of electricity in

the energy transition, are shown in Figure 2-10. It can be observed that countries in the Sun Belt region (between the tropic of Cancer and tropic of Capricorn) have great potential for solar energy all year round, while regions in the northern and southern temperate zones have exceptional wind energy potential.

Financial and Technical Assumptions

Financial details of all technologies are a critical element in determining a cost optimal energy transition pathway. Moreover, the learning curves of all relevant technologies have been considered directly or indirectly in determining future costs. The financial and technical assumptions are obtained from various sources, which are enlisted in the Table A5 in the Appendix.

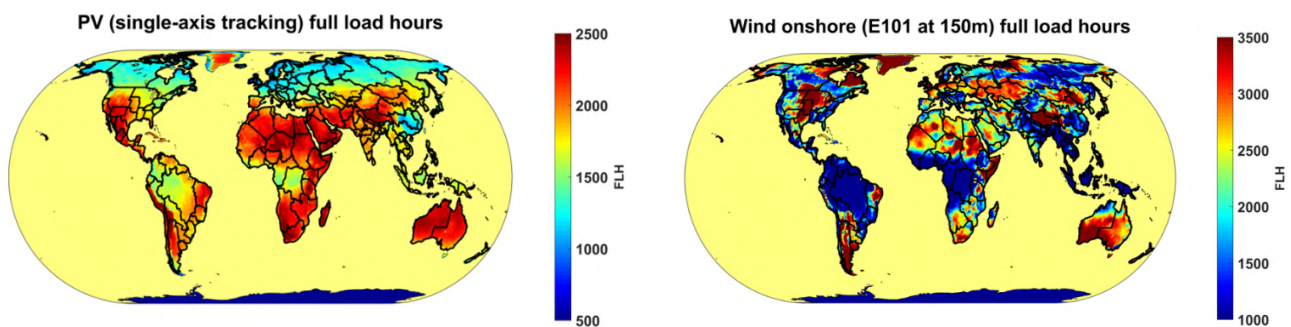

Figure 2-10: Global mapping of annual full load hours for solar PV with single-axis tracking (left) and onshore wind at 150 m hub-height (right).

Model Setup and Simulation

The model has integrated all crucial aspects of the power, heat, transport, and desalination sectors, which are further described in the Appendix on a sectoral basis and shown in Figures A1-A5. Consequently, 108 energy technologies across the different sectors are introduced into the model, which can be categorised:

- electricity generation technologies: renewable energy (RE), fossil, and nuclear technologies;
- heat generation technologies: renewable and fossil;
- energy storage technologies: electricity and heat storage technologies;
- transport technologies: different modes and sub-segments with respective powertrains of transport;
- fuel conversion technologies: fuels for transport, power generation and heat generation;
- fuel storage technologies: fuel storage for transport, fuel storage for power and heat generation;
- desalination technologies and water storage; and
- electricity transmission technologies.

The simulations are carried out in a 2-stage approach containing prosumer modelling and a subsequent system modelling. In an initial stage, the prosumer simulations determine a cost effective share of prosumers across the 145 sub-regions through the transition from 2015 to 2050, in five-year intervals.

Prosumer Modelling

The energy system transition analysis also consists of distributed self-generation and consumption of residential, commercial and industrial PV prosumers, which are simulated with a different model describing the PV prosumer and battery capacity development. PV prosumers have the option to install their own rooftop PV systems either with or without lithium-ion batteries. PV prosumers can also draw power from the grid in order to fulfil their energy demands^{6,56}, while having the option to feed-in surplus electricity to the grid. The target function for PV prosumers is the minimisation of the cost of consumed electricity, calculated as a sum of self-generation, annual costs and the cost of electricity consumed from the grid, minus the cost of electricity sold to the grid. Furthermore, Table A3-A5 provides the full set of technical as well as financial assumptions utilised in the modelling of prosumers.

Similar to the power sector, the heat sector prosumers can also fulfil their individual heating demand. This is enabled by PV utilisation for residential domestic hot water demand and space heating demand where applicable. Space heating demand varies across the different regions of the world depending on climatic and weather conditions. A partial self-supply to cover the electricity demand of individual heating pumps and heating rod systems is taken into account, if it is economically attractive to prosumers.

System Simulation

In a second stage, the simulations are carried out on a sectoral basis for the 145 sub-regions through the transition period from 2015 to 2050, in five-year intervals.

Power and Heat Sectors

The LUT Energy System Transition model simulates an energy system development under specific given conditions. The system components are shown in Figure A1 of the Appendix for the sectors power and heat. For every time step, which is 5 years, the model defines a cost optimal energy

system structure and operation mode for the given set of constraints: power demand, heat demand for industry, space and domestic hot water heating, available generation and storage technologies, financial and technical parameters, and limits on installed capacities for all available technologies. The target of the optimisation is the minimisation of total system cost. Costs of the system are calculated as a sum of the annualised capital and operational expenditures including ramping costs as well as fuel costs and GHG emissions costs for all available technologies. The transition simulation was performed for the period from 2015 to 2050 in five-year time intervals. The detailed methodology as well as the mathematical equations for the cost optimisation are presented in the Appendix.

Transport Sector

The transport sector undergoes a transition towards massive electrification across the different modes. Furthermore, synthetic fuels produced by renewable energy meet the fuel demand from the different transport modes through the transition. A more detailed methodology for the cost optimisation is presented in the Appendix. Furthermore, information and data for transportation demand along with fuel shares and specific energy demand are provided in Breyer et al., (2018)⁸.

Desalination Sector

The LUT Energy System Transition model is used to identify the lowest cost configuration of 100% renewable energy hybrid power plants to enable a low water production cost. The levelised cost of water includes the water production cost as well as the pumping of water from the coastline to the site of demand. An hourly simulation is performed with a modified version of the LUT Energy System Transition model as indicated in Figure A5. The detailed methodology as well as the mathematical equations for the cost optimisation are presented in the Appendix. Also, a more detailed description of the methodology, data, and assumptions can be found in Caldera et al.^{27,57,58}.

Tracing GHG Emissions

As the primary objective for the global energy transition is the reduction of GHG emissions and achieving the goals set by the Paris Agreement, costs for CO₂ emissions during the transition period are considered while modelling the energy transition scenario. This results in different emissions reduction pathways corresponding to the various countries and regions across the world. Moreover, different regions achieve zero GHG emissions on different time scales across the power, heat, transport and desalination sectors. Refer to Table A5 in the methodology section of the Appendix for GHG emissions costs.

Estimating Job Prospects

The direct energy jobs created during the global energy transition from 2015 to 2050 are estimated utilising the employment factor approach in the power sector only, across the different regions. Furthermore, direct employment associated with energy generation, storage and transmission is estimated. Also, direct employment including jobs in manufacturing, construction and installation, operations and maintenance, fuel supply and transmission associated with electricity generation,

storage and transmission have been estimated for the global power sector across nine major regions. A detailed overview of the methodology and various assumptions can be found in Ram et al. (2019)⁵⁹. Furthermore, the employment factors used in the estimation of jobs created during the energy transition from 2015 to 2050 across the global power sector are presented in the Appendix Table A8.

Best Policy Scenario

The LUT Energy System Transition model can be utilised to generate wide-ranging energy scenarios across the different regions of the world on a global-local scale. However, the objective of this study is to highlight an energy scenario that can achieve the goals of the Paris Agreement of achieving zero GHG emissions from the energy sector by 2050, in a technically feasible and economically viable manner. Therefore, a Best Policy Scenario is envisioned across the power, heat, transport, and desalination sectors globally. Transitioning from the current system in 2015 towards a cost optimal zero GHG emissions system in 2050, based completely on renewables.

3. The Global Energy Transition: Regional and Sectoral Outlook

The results of the global energy transition are presented in a globally aggregated Best Policy Scenario, followed by independent results across the nine major regions. Links to the detailed results of the energy transition across all major regions and globally are provided in the Appendix.

3.1. Global

The development of the energy sector comprising of power, heat, transport and desalination sectors is characterised by a dynamically growing electricity demand driven by developing and emerging countries. A global cumulative average annual growth rate of about 1.8% in final energy demand drives the transition. This is disaggregated into final energy demand growth for power and heat, desalinated water demand and transportation demand linked to powertrain assumptions. The powertrain assumptions capture the transition from a fossil-based transport sector towards a transport sector with high levels of direct electrification and adoption of synthetic fuels, based on indirect electrification. Additionally, this leads to a comprehensive electrification across the various energy sectors, which substantially increases overall energy efficiency, enabling an even higher growth rate in the provided energy services. This results in an average annual growth rate of about 0.4% globally, in total primary energy demand (TPED). TPED decreases from almost 130,000 TWh in 2015 for the mentioned energy sectors to around 105,000 TWh by 2035 and increases up to 150,000 TWh by 2050, as highlighted in Figure 3.1-1. This also forms the basis for this study, which assumes a very high rate of direct and indirect electrification. In comparison, current practices with low shares of electrification result in a TPED of nearly 300,000 TWh by 2050 as shown in Figure 3.1-1. The massive gain in energy efficiency is primarily due to a high level of direct electrification in final energy demand, resulting in around 50% by 2050. In addition, major parts of the energy system are

indirectly electrified, in particular through power-to-heat in the form of heat pumps and electricity-based synthetic fuels. Moreover, this leads to a very high share of electricity, of around 89% in TPED by 2050. The comprehensive electrification of the entire energy system is one of the most fundamental results of this study, and it leads to efficiency savings of nearly 150,000 TWh compared to the continuation of current practices with low shares of electrification. The detailed global results for the energy transition are available in a supplementary data file, the link for the file can be found in the Appendix.

World population is expected to grow from 7.2 to 9.7 billion by 2050 as indicated in Figure 3.1-1, while the average per capita primary energy demand decreases from around 17 MWh/person in 2015 to 12 MWh/person by 2035 and increases up to around 15 MWh/person by 2050, as shown in Figure 3.1-1. This also indicates a fundamental change in terms of energy consumption for people around the world, as the predominant energy carrier transits from being fossil fuels towards electricity. The fundamental structure of the global energy system shifts from conventional low-efficient burning of extracted fuels towards pure exergy, which is electricity generated from very low cost solar and wind and other natural energy resources. Furthermore, Figure 3.1-1 highlights the role of electricity as the main energy carrier across the different energy sectors, while the utilisation of fossil fuels declines completely to zero on a per capita basis by 2050.

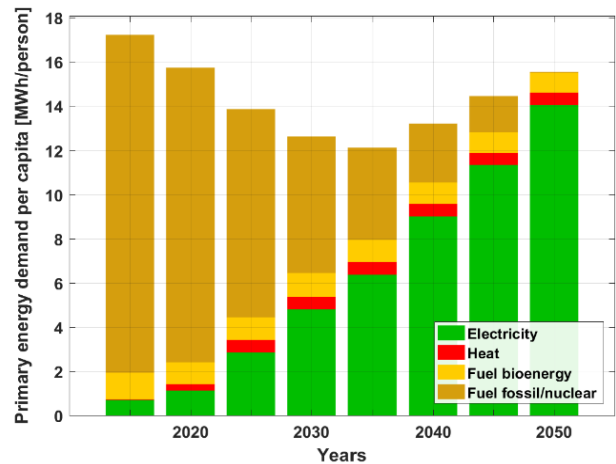
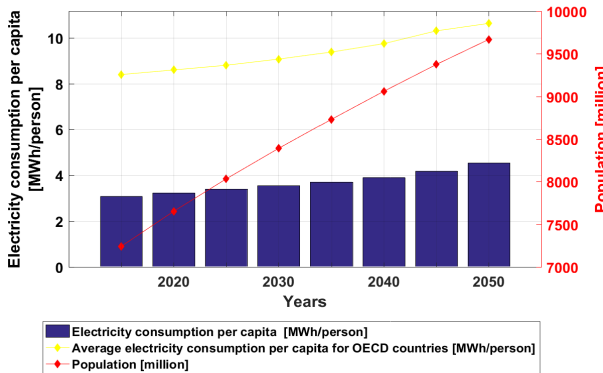
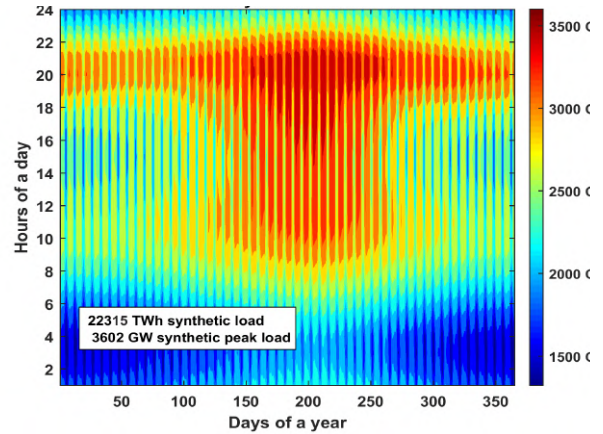
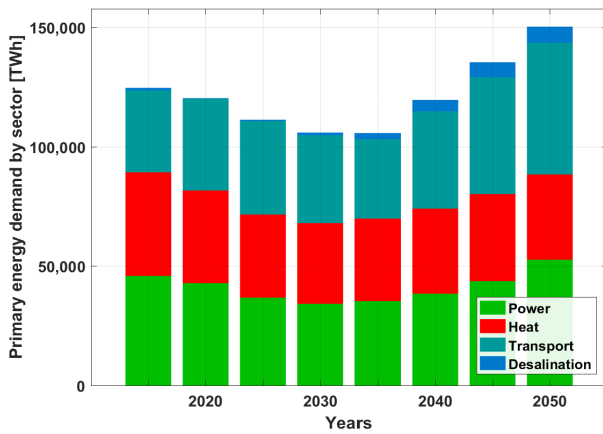

Figure 3.1-1: Global – Primary energy demand sector-wise (top left), efficiency gain in primary energy demand (top right), electricity consumption per capita with population (bottom left) and primary energy demand per capita (bottom right) during the energy transition from 2015 to 2050.

Energy Supply

The global electricity generation capacity satisfies demand from all energy sectors including power, heat, transport and desalination. The total installed capacity grows massively from around 6300 GW in 2015 to around 78,000 GW by 2050 as shown in Figure 3.1-2. In the initial period of the transition, a larger share of wind capacities are installed up to

2030, but in the later part of the transition solar PV dominates the shares of installed capacities reaching almost 63,400 GW by 2050. On the other hand, the shares of fossil fuels and nuclear decline through the transition to zero by 2050. Some shares of gas remain, but the fuel switches from fossil-based gas to synthetic natural gas produced with renewable electricity and biomethane.

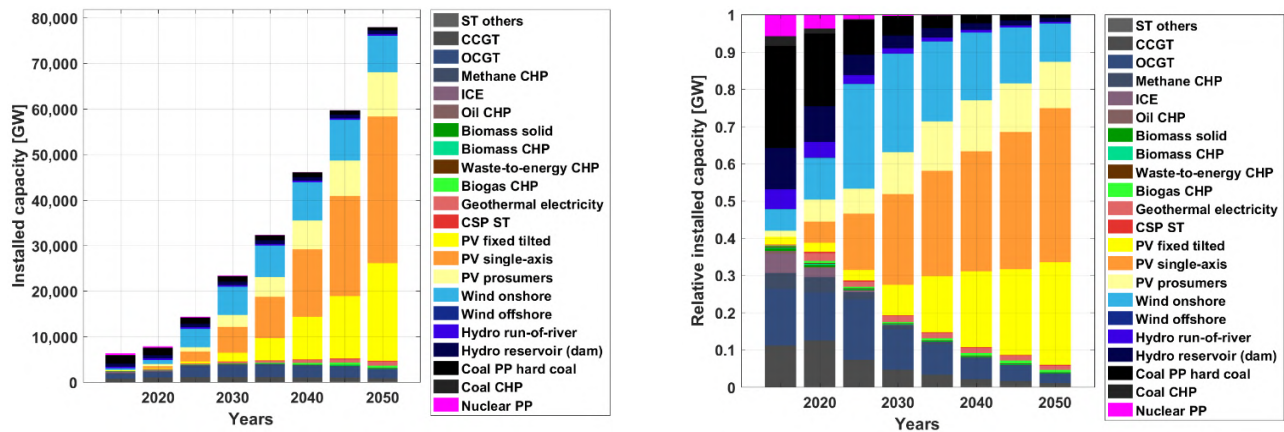

Figure 3.1-2: Global – Technology-wise installed capacities (left) and technology-wise shares of installed capacities (right) during the energy transition from 2015 to 2050.

Similarly, solar PV emerges as the major energy supply source, increasing to around 32% by 2030 and further onto 73% by 2050 as indicated in Figure 3.1-3. This exponential growth in solar PV energy supply is driven by excellent resource access around the world and the massive cost decline expected up to 2050. Wind energy is the major source of renewables in the early part of the transition, with the share of energy supply increasing up to 42% by 2030. Thereafter, as solar PV becomes more cost effective the share of wind energy steadily declines to about 20% until 2050. Hydropower, geothermal and bioenergy have some shares in the final energy mix by 2050, with complementary roles through the transition. Moreover, they do contribute substantially in some of the regions across the world, with major shares

in energy supply through the transition. On the other hand, the share of fossil fuels and nuclear in the electricity generation mix are observed to decline completely through the transition period, as shown in Figure 3.1-3.

Heat pumps play a significant role in the heat sector with a share of over 40% of heat generation by 2050 coming from heat pumps on district and individual levels, as shown in Figure 3.1-3. Additionally, some shares of electric heating along with non-fossil gas and biomass-based heating contribute to the heat supply by 2050. On the contrary, the shares of coal-based heating along with fossil oil and gas based heating decrease through the transition, from more than 75% in 2015 to zero by 2050.

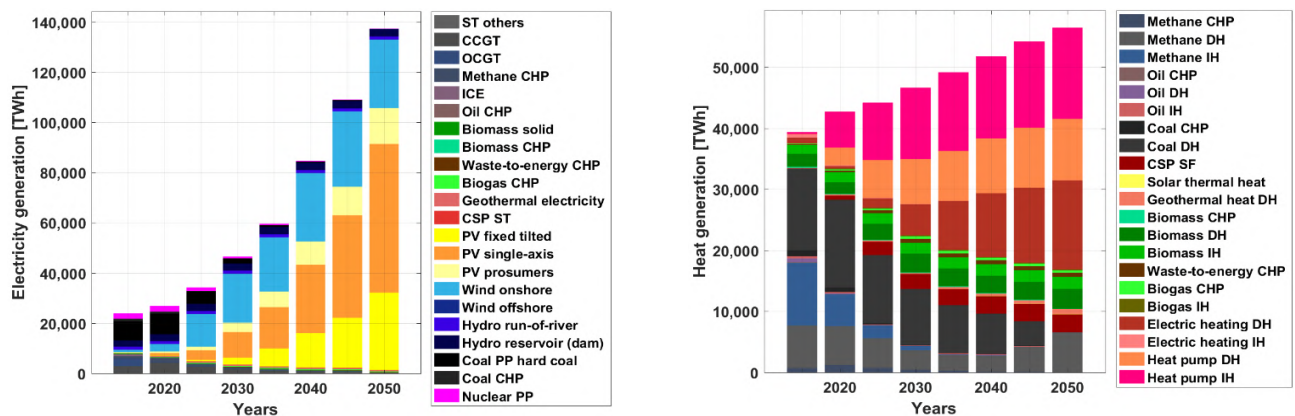

Figure 3.1-3: Global – Technology-wise electricity generation (left) and technology-wise heat generation (right) during the energy transition from 2015 to 2050.

Energy Storage

Storage technologies play a vital role in enabling the transition towards a fully renewable energy system across all sectors. As shown in Figure 3.1-4, a significant share of electricity demand is covered by storage that increases through the transition period up to nearly 5000 TWh_{el} by 2030 and further significantly increases to over 30,000 TWh_{el} by 2050. As the shares of solar PV and wind energy increase significantly beyond 2030, the role of

storage is crucial in providing uninterrupted energy supply. The ratio of electricity demand covered by energy storage to electricity generation increases significantly to around 18% by 2035 and further on to about 23% by 2050, as shown in Figure 3.1-4. Electricity storage technologies cover most of the storage requirements from the electricity sector, complemented with some shares of electricity derived from stored heat. This cross-sectoral storage is enabled through an integrated power and heat sector.

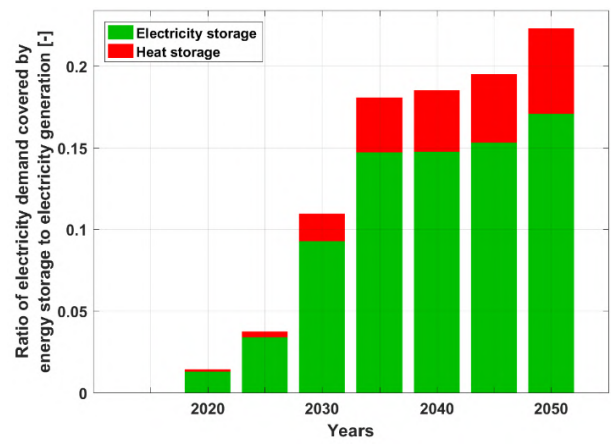
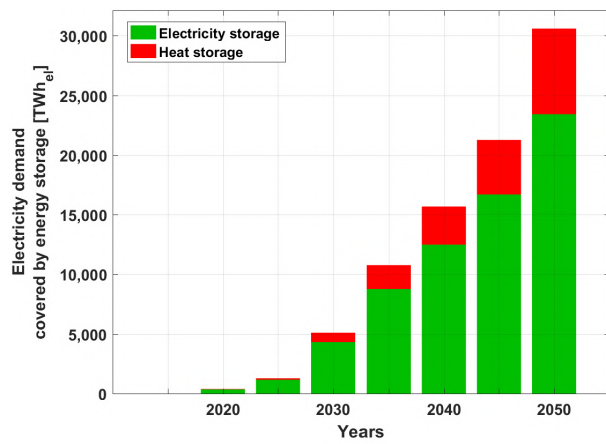

Figure 3.1-4: Global – Electricity demand covered by energy storage (left) and ratio of electricity demand covered by different forms of energy storage (right) during the energy transition from 2015 to 2050.

Similarly, heat storage plays a vital role in covering the heat demand across the different regions of the world. As shown in Figure 3.1-5, storage output covers more than 16,000 TWh_{th} of total heat demand in 2050 and heat storage technologies play a vital role with minor shares of electricity storage providing heat. Heat storage

technologies play a vital role in the latter part of the transition, wherein heat pumps and electric heating cover most of the heat demand. The ratio of heat demand covered by energy storage to heat generation increases substantially to about 26% by 2050, as indicated in Figure 3.1-5.

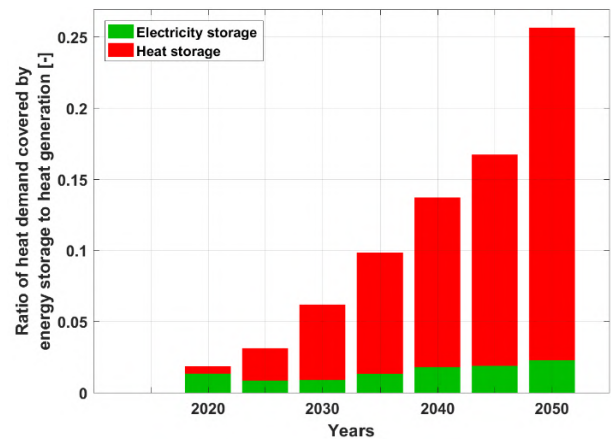
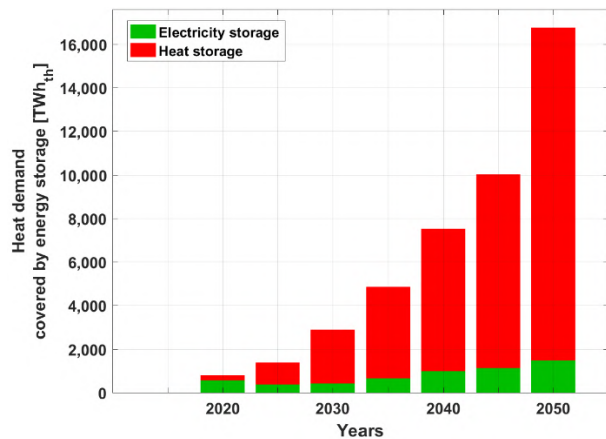

Figure 3.1-5: Global – Heat demand covered by energy storage (left) and the ratio of heat demand covered by different forms of energy storage (right) during the energy transition from 2015 to 2050.

Costs and Investments

Renewable energy along with electricity and heat storage technologies evolve to become the backbone of the global energy supply system in the first half of the 21st century, while costs remain stable through the transition until 2050. Additionally, the total annual costs that represent the annualised costs of the entire energy sector in 5-year time intervals are in the range of 5100-7200

b€ through the transition period. Furthermore, the total annual costs are well distributed across the 3 major sectors of power, heat and transport, with minor shares in desalination in the later part of the transition as shown in Figure 3.1-6. From an operational perspective, fuel costs are replaced by capital and operational expenditures through the transition, as shown in Figure 3.1-6.

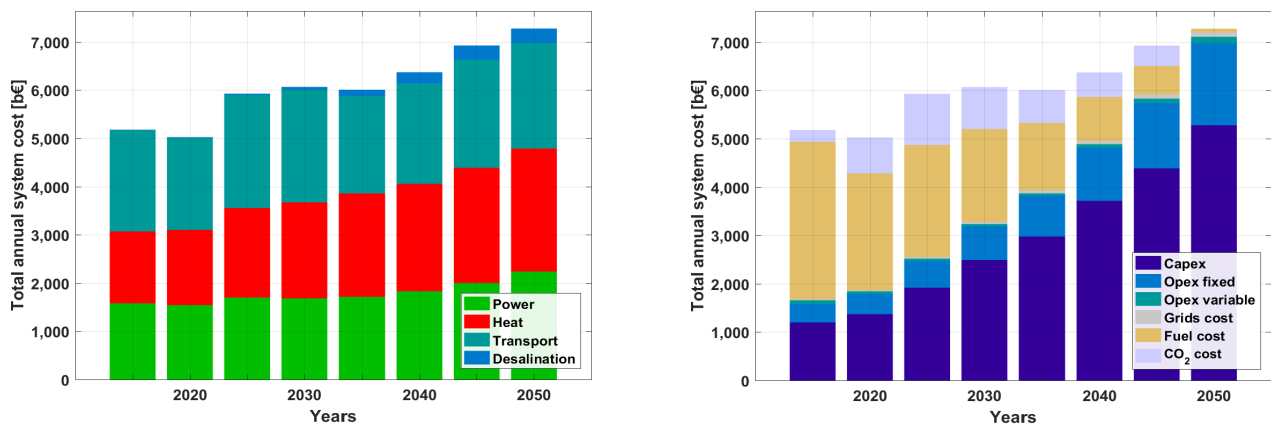

Figure 3.1-6: Global – Annual system costs, sector-wise (left) and functionality-wise (right) during the energy transition from 2015 to 2050.

Investments, which are capital expenditures for installed capacities of energy technologies that occur in the 5-year time periods are well spread across a range of technologies. A majority of the investments are in solar PV, wind energy, batteries, heat pumps and synthetic fuel conversion technologies up to 2050, as shown in Figure 3.1-7. Investments are seen to increase substantially from over 4500 b€ in 2020 to around 14,000 b€ by 2050, enabling prospects for strong economic growth across the world. Moreover, the cumulative investment costs are about 67,200 b€ through the energy transition, with a majority in the later part from 2040 onwards. Investments are mainly in solar

PV, wind energy, batteries, heat pumps and technologies in the synthetic fuels production value chains. Levelised cost of energy remains around 50-57 €/MWh through the transition, as shown in Figure 3.1-7. The total system wide levelised cost of energy are in 2050 slightly less than in 2015. This corroborates that an energy transition towards 100% renewable energy is an economically attractive proposition. In addition, levelised cost of energy is increasingly dominated by capital costs as fuel costs lose importance through the transition period, which could mean increased levels of energy security for countries around the world by 2050.

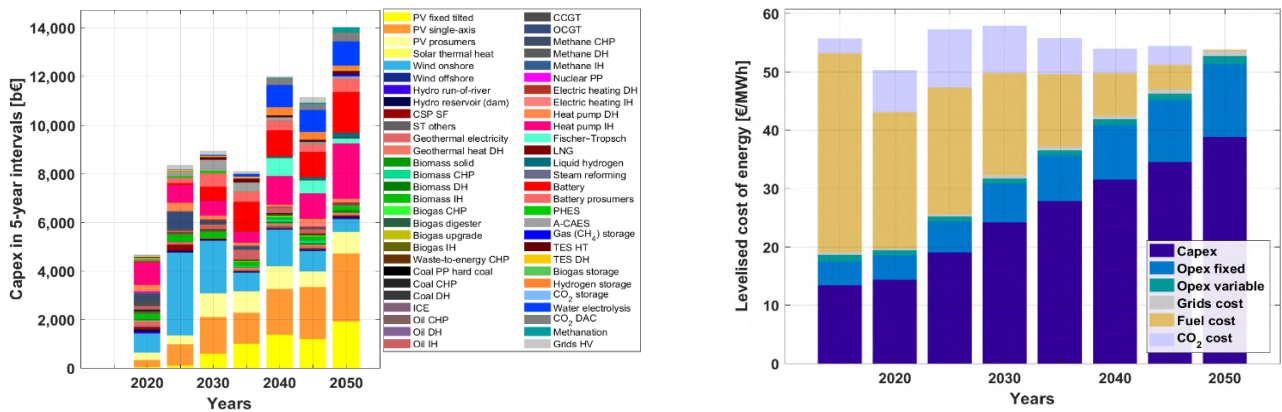

Figure 3.1-7: Global – Capital costs for five-year intervals (left) and levelised cost of energy (right) during the energy transition from 2015 to 2050.

Outlook across Sectors

Different trends in the power, heat, transport, and desalination sectors across the world emerge through the transition. As the sectors transition towards higher shares of renewables in the energy supply mix, different technologies have vital roles in ensuring the operational stability of the energy system. A closer look at the individual sectors provides further insights into the energy transition across the world towards 100% renewable energy.

Power and Heat

The total installed power generation capacity for the sectors power and heat increases from nearly 6,200 GW in 2015 to around 45,250 GW by 2050,

as shown in Figure 3.1-8. Across the power sector, solar PV with 34,800 GW and wind energy with 4,600 GW constitute the majority of installed capacities by 2050, complemented with some shares of hydropower, bioenergy and geothermal. In the heat sector, heat pumps, electric heating, and biomass-based heating constitute the majority of installed capacities by 2050, also shown in Figure 3.1-8. A significant increase in installed capacity of heat pumps and biomass-based heating occurs in the final five-year period leading up to 2050, as fossil fuels are completely eliminated from the energy system. The remaining share of oil and gas based heating switches from fossil fuels to renewable based synthetic fuels by 2050.

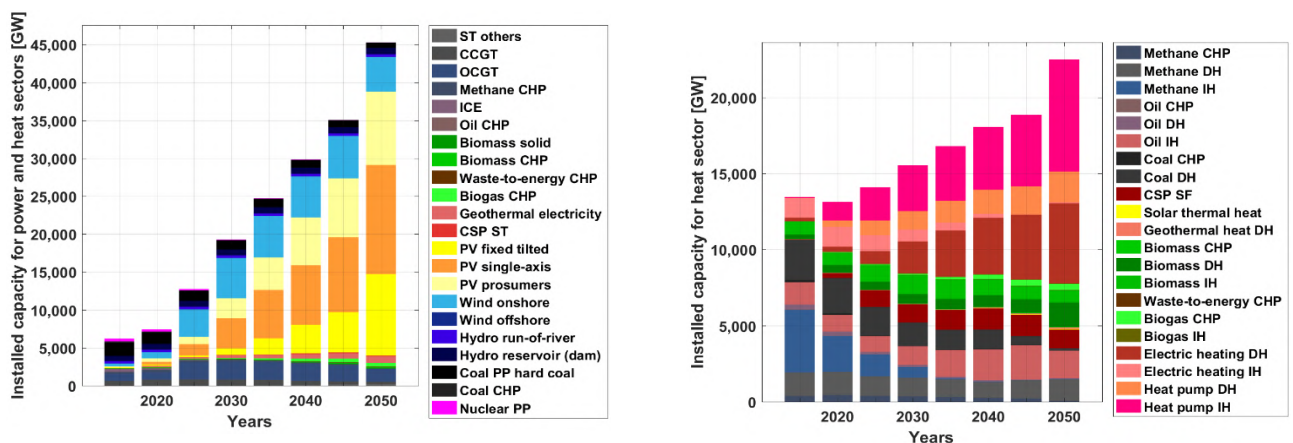

Figure 3.1-8: Global – Technology-wise installed capacities for power (left) and heat (right) during the energy transition from 2015 to 2050.

The power and heat sector, previously dominated by fossil fuels and nuclear in 2015 shifts towards a solar PV and wind energy dominated sector by 2050, with some hydropower and bioenergy as shown in Figure 3.1-9. The primary electricity generation for the sectors power and heat increases from around 23,300 TWh in 2015 to

around 76,100 TWh by 2050, which is primarily from solar PV and wind. Whereas, heat generation increases from around 39,400 TWh in 2015 to around 56,500 TWh by 2050, which is predominantly from heat pumps and electric heating with some biomass-based heating, also shown in Figure 3.1-9.

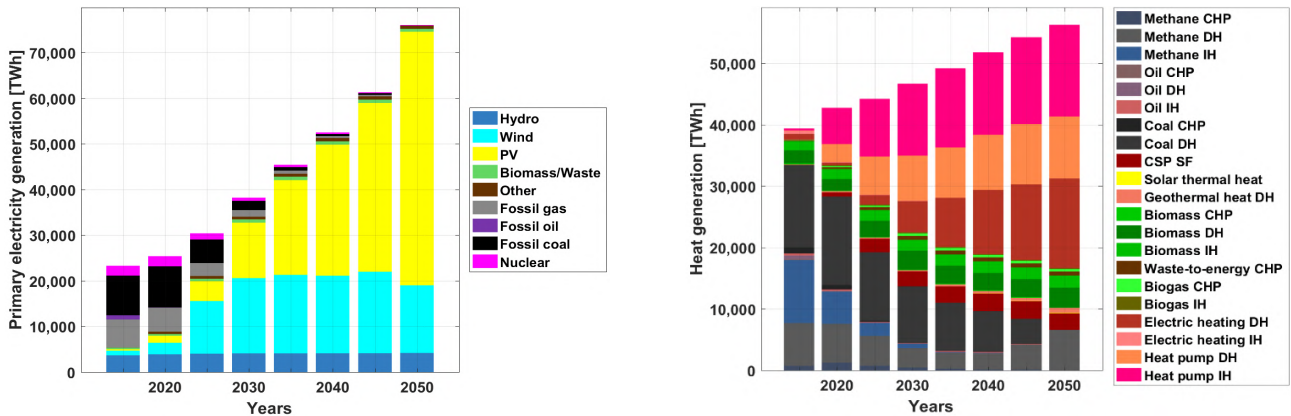

Figure 3.1-9: Global – Primary electricity generation (left) and technology-wise heat generation (right) during the energy transition from 2015 to 2050.

The installed electricity storage capacity increases from just about 1 TWh in 2015 to around 64 TWh by 2050, as shown in Figure 3.1-10. Utility-scale and prosumer batteries with some shares of PHEs and A-CAES are installed through the transition. The installed capacities of A-CAES are also a consequence of the modelling approach, which prioritises full domestic energy supply across the different major regions. The installed heat storage capacity increases gradually until 2045 to over 200 TWh, but

in the final five-year period up to 2050, a massive capacity of gas storage of nearly 600 TWh is added, as shown in Figure 3.1-10. This substantial capacity addition is mainly to provide seasonal storage across various major regions covering the heat demand in the absence of fossil fuels. In addition, TES up to 40 TWh is installed by 2050 to meet the regular heat demand.

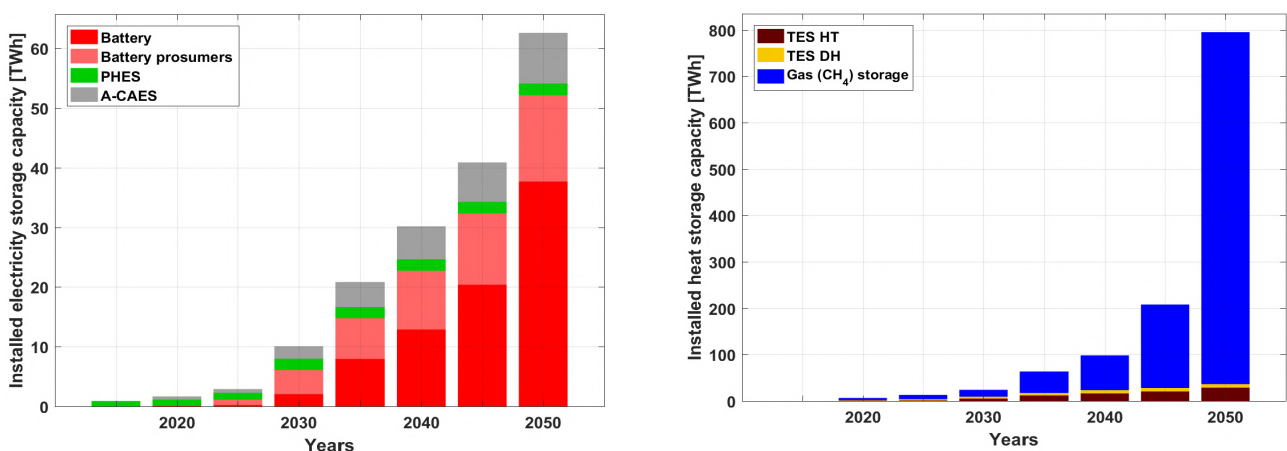

Figure 3.1-10: Global – Installed electricity storage capacities (left) and heat storage capacities (right) during the energy transition from 2015 to 2050.

Utility-scale and prosumer batteries contribute a major share of electricity storage output with nearly 92% by 2050, as highlighted by Figure 3.1-11. In addition, PHES and A-CAES contribute through the transition with output reaching 23,000 TWh_{el} by 2050. TES emerges as the most relevant heat

storage technology with around 40-60% of heat storage output from 2030 until 2050, also seen in Figure 3.1-11. Gas storage contributes around 40% of the heat storage output in 2050 covering predominantly seasonal demand, which is covered by fossil gas before 2050.

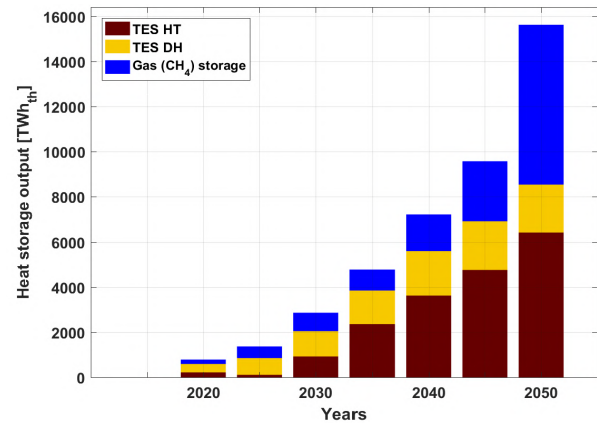
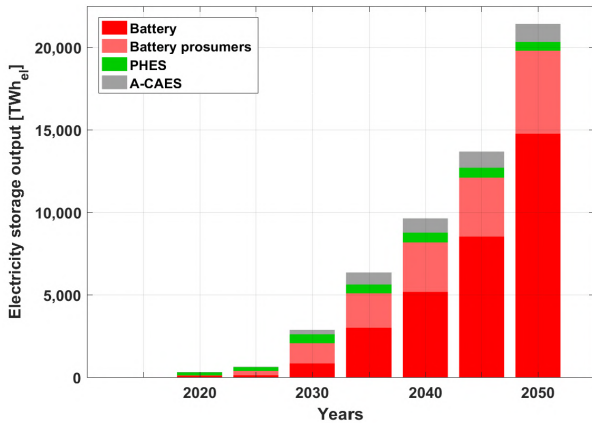

Figure 3.1-11: Global – Electricity storage output (left) and heat storage output (right) during the energy transition from 2015 to 2050.

Levelised cost of electricity (LCOE) of the power sector decreases substantially from around €78/MWh in 2015 to around €53/MWh by 2050, as shown in Figure 3.1-12. The derived LCOE in 2015 for the power sector in this more comprehensive study is higher by about 8 €/MWh compared to the LCOE of just the power sector derived earlier, which is around 70 €/MWh in 2015⁴⁶. This is mainly a result of the integration of the power and heat sectors, which include fossil fuels based combined heat and power plants that lead to additional costs. In 2050, the LCOE would further decline to around 45 €/MWh when referring to overnight costs. Thus, the resulting cost beyond 2050 will further decline in the following periods by about 15%. This is mainly a consequence of major reinvestments in the periods after 2050 with capital costs of the year 2050 and beyond. Further, capex reductions are expected making overall energy costs in the second half of the century extremely low cost, which might lead to a cost decline higher than 15%, since that can be already achieved on the cost basis of the year 2050. Moreover, the LCOE as

compared to the previous LCOE of the global power sector transition presented in Ram et al.⁴⁶ is much lower. This is the effect of an integrated power and heat sector, wherein CHP plants provide both heat and electricity, which are extremely cost effective and reduce the overall energy costs. This shows a methodological improvement in the modelling of integrated power and heat sectors. LCOE is predominantly comprised of CAPEX as fuel costs decline through the transition. LCOH of the heat sector increases from around €39/MWh in 2015 to around €45/MWh by 2030 and further on to around €49/MWh by 2050, as shown in Figure 3.1-12. LCOH is predominantly comprised of CAPEX as fuel costs decline through the transition. Despite a substantial increase in heat demand across the world, mainly driven by industrial process heat and increased space heating driven by more space per person, the LCOH increases marginally up to 2050. This can also be attributed to the increased levels of electrification in the heating sector.

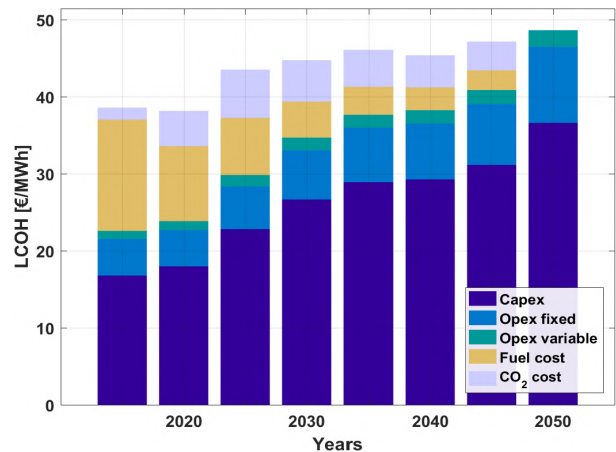
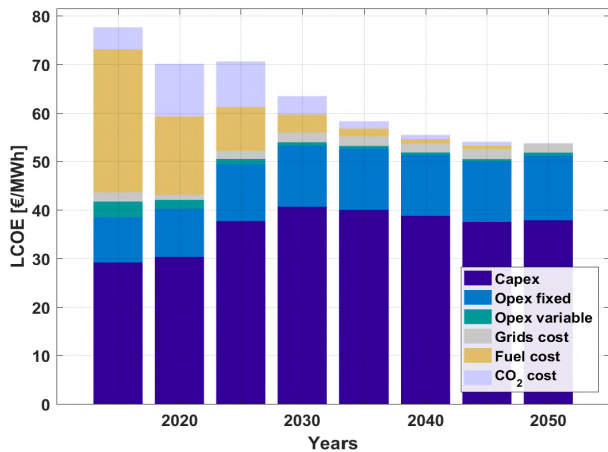

Figure 3.1-12: Levelised cost of electricity (left) and levelised cost of heat (right) during the energy transition from 2015 to 2050.

Investments are well spread across a range of power generation technologies with the majority share in wind energy up to 2030, beyond which solar PV dominates investments up to 2050, as shown in Figure 3.1-13. This is predominantly the result of high levels of cost competitiveness of solar PV plus batteries in the later part of the transition as show cased in Ram et al., (2017) and Breyer et

al., (2018). While, investments in the heat sector are mainly in heat pumps and some shares in biomass and electric heating up to 2050, also shown in Figure 3.1-13. The steep increase in heat pump investments in the final five-year period until 2050 is mainly to cover the heat demand in the absence of fossil fuels, as well as the lower costs of heat pumps by 2050.

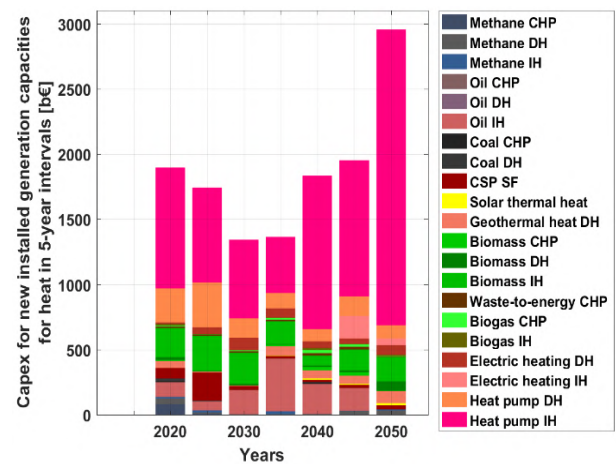
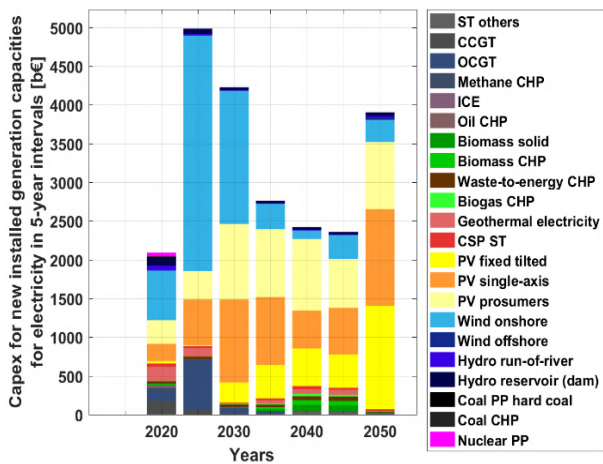

Figure 3.1-13: Global – Capital costs of installed generation capacities in five-year intervals for electricity (left) and heat (right) during the energy transition from 2015 to 2050.

Transport

The final energy demand of the transport sector across the world is around 34,000 TWh in 2015, which remains in the range of 31,000 – 38,000 TWh through the transition with 35,000 in 2050. However, this demand remains quite stable, compared to the massive increase in transportation demand, through the transition mainly due to the substantial efficiency gains brought about by electrification of the sector as shown in Figure 3.1-14. Fossil fuel consumption in the transport sector across the world is seen to decline through the transition from about 97% in 2015 to zero by 2050. On the other hand, liquid fuels produced by renewable electricity contribute over 30% of final

energy demand in 2050. In addition, hydrogen constitutes more than 25% of final energy demand in 2050. Sustainably produced biofuels contribute a minor share to enable a complete elimination of fossil fuel usage in the transport sector. Sustainable biofuels produced from energy crops such as Jatropha could play a vital role in ensuring 100% renewable energy systems⁶⁰. Electrification of the transport sector creates an electricity demand of around 52,000 TWh_{el} by 2050. The massive demand for liquid fuels kicks in from 2040 onwards up until 2050, as indicated in Figure 3.1-14. This is predominantly to cover demand from the marine and aviation sectors where renewables-based synthetic fuels are crucial in the later part of the transition.

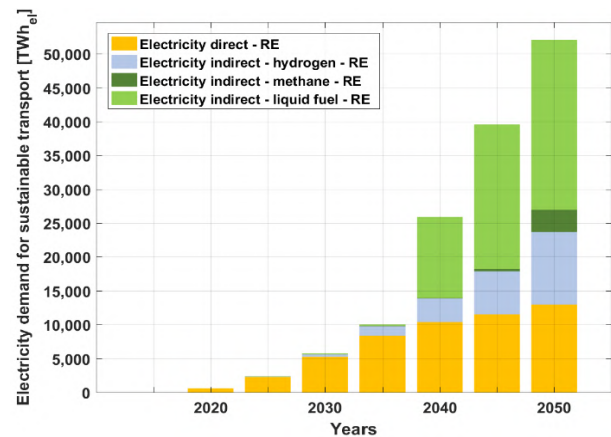
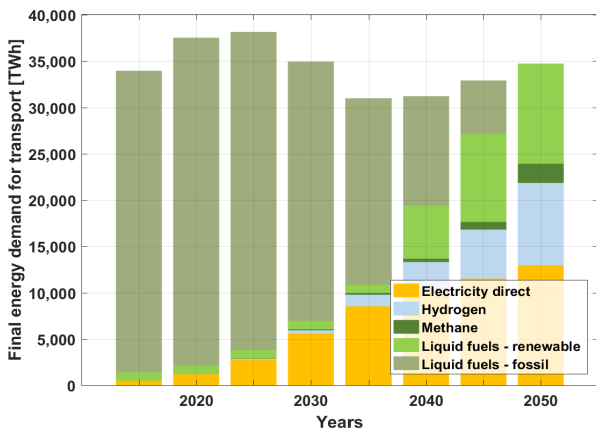

Figure 3.1-14: Global – Final energy demand for transport (left) and electricity demand for sustainable transport (right) during the energy transition from 2015 to 2050.

Installed power generation capacities for the transport sector increase substantially through the transition to around 28,700 GW by 2050, as shown in Figure 3.1-15. Solar PV and wind energy form the majority share of the power generation capacity for the transport sector, as they are the lowest cost energy sources through the transition. Most of the capacity addition happens 2040 onwards, with a

rapid change in the transport sector towards increased levels of electrification and a massive demand for synthetic fuels kicking in. Similarly, electricity generation increases substantially up to almost 54,500 TWh by 2050, also seen in Figure 3.1-15. Wherein, solar PV and wind energy generate all the electricity required to meet the demand of the transport sector by 2050.

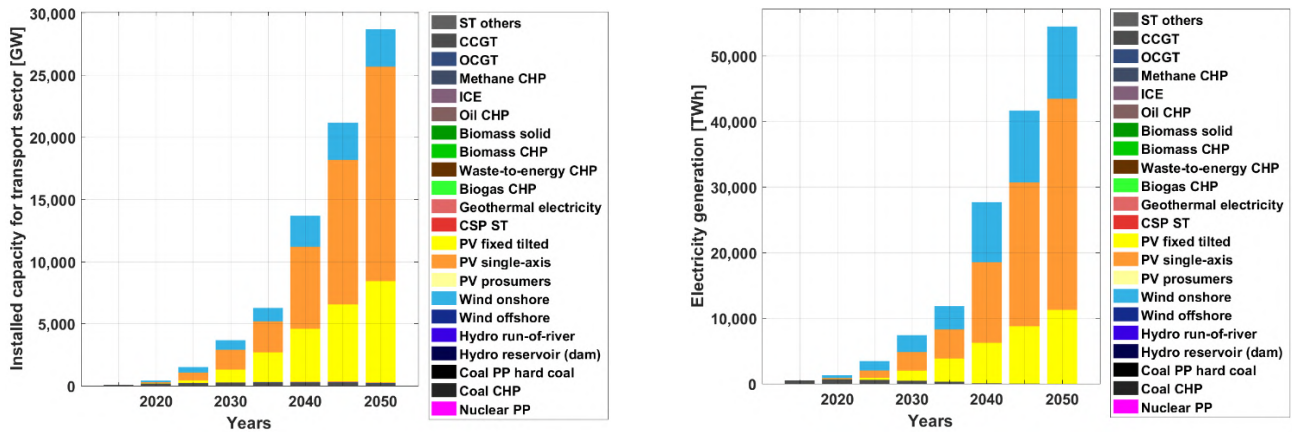

Figure 3.1-15: Global – Transport sector installed power generation capacity (left) and electricity generation (right) during the energy transition from 2015 to 2050.

A critical aspect to complement the electrification of the transport sector is the installation of storage technologies. As seen in Figure 3.1-16, the installed capacities of electricity storage increase through the transition to around 23 TWh by 2050. The majority of installed capacities are utility-scale batteries and A-CAES. Similarly, electricity storage output increases through the transition to over 6,500 TWh_{el} by 2050 as shown in Figure 3.1-16. Utility-scale batteries play a vital role as they contribute a major portion of the output through

the transition, with over 5000 TWh_{el} by 2050. The relatively low electricity storage requirement of less than 10% of generated electricity for the transport sector is enabled by the flexible operation of batteries, water electrolyser units, and hydrogen buffer storage for synthetic fuel production. The integration of renewable energy generation and synthetic fuel production complemented by storage technologies enhance the overall efficiency of supplying energy to the transport sector.

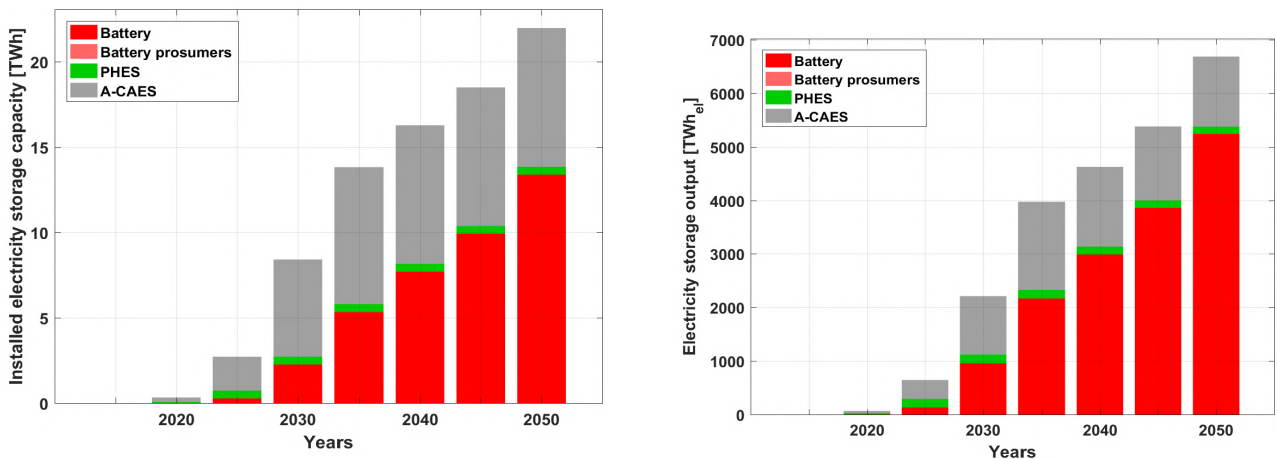

Figure 3.1-16: Global – Transport sector installed electricity storage capacity (left) and electricity storage output (right) during the energy transition from 2015 to 2050

Another essential aspect in the transition of the transport sector towards higher electrification completely based on renewable energy is the production of synthetic fuels, hydrogen and sustainable biofuels. As indicated in Figure 3.1-17, the installed capacities of fuel conversion technologies increase substantially from 2040 onwards to over 14,000 GW by 2050. Water electrolysis forms the majority share of fuel conversion capacities through the transition,

followed by hydrogen liquefaction units and Fischer-Tropsch synthesis plants. Additionally, heat is needed during the production of synthetic fuels, mainly for energy-efficient CO₂ direct air capture, and this is enabled by managing and reutilising process heat, which is otherwise not useable. Heat utilisation reaches over 7,000 TWh_{th} by 2050, which is comprised of excess heat and recovered heat, as shown in Figure 3.1-17.

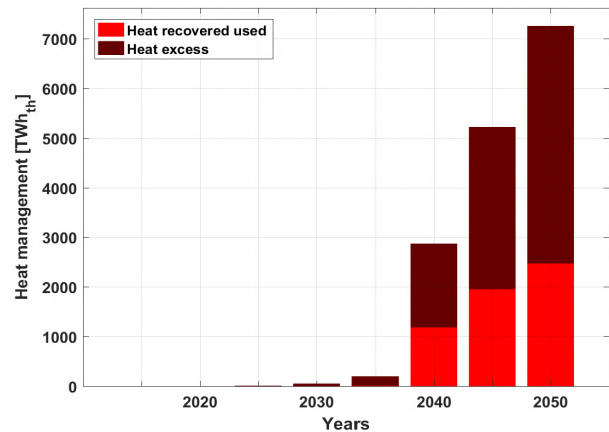
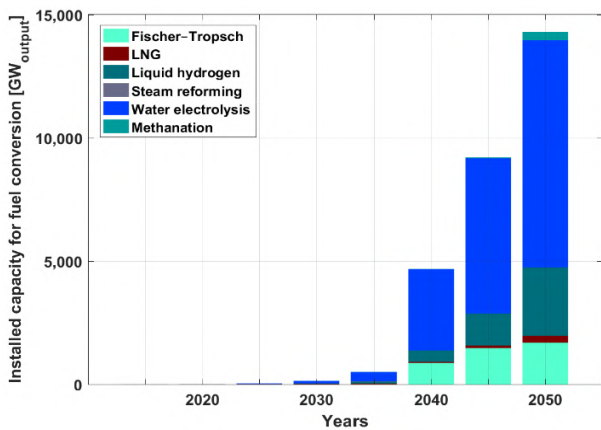

Figure 3.1-17: Global – Transport sector installed capacity for fuel conversion (left) and heat management (right) during the energy transition from 2015 to 2050.

Similarly, gas storage is necessary in the production of synthetic fuels. As shown in Figure 3.1-18, the installed storage capacity for gas increases through the transition to almost 150 TWh by 2050. Hydrogen storage is the major gas stored through the transition, with a minor share for methane gas. Whereas in 2050, a substantial portion of methane is stored for increased levels of synthetic fuel production for the complete defossilisation of the transport sector. CO₂ direct air capture and CO₂ storage, which are vital in the production of

synthetic fuels, are installed predominantly from 2040 onwards. The installed capacity for CO₂ direct air capture and CO₂ storage increases up to around 2,400 MtCO₂ by 2050, as shown in Figure 3.1-18. The major share of installed capacity is CO₂ direct air capture on an annual basis, as compared to CO₂ storage. Despite having lower storage capacities, CO₂ storage has substantial utilisation and correspondingly high throughputs through the transition.

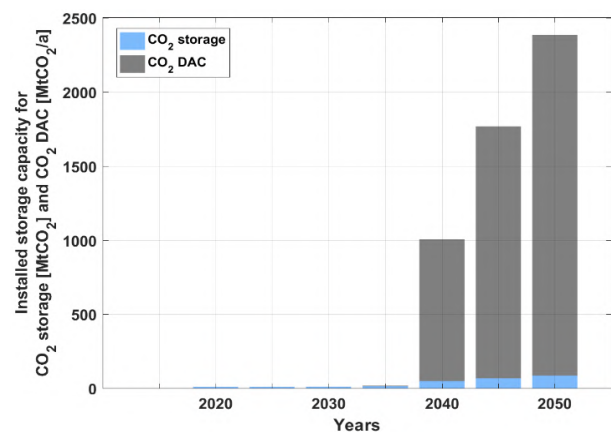
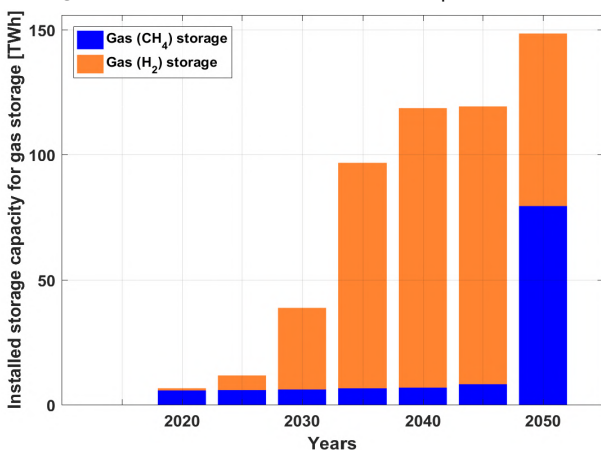

Figure 3.1-18: Global – Transport sector installed capacity for gas (methane and hydrogen) storage (left) and CO₂ direct air capture and CO₂ storage (right) during the energy transition from 2015 to 2050.

Fuel costs are a decisive factor in the overall energy mix for the transport sector across the different regions of the world and their developing trends on a global basis are highlighted in Figure 3.1-19. Fischer-Tropsch (FT) and Synthetic Natural Gas (SNG) fuel costs decline through the transition up to 2050. FT fuels are in the range of costs of fossil liquid fuels including GHG emissions costs, in the range of 90-100 €/MWh from 2040 onwards and become more cost competitive by 2050 at around 85 €/MWh. In addition, SNG is more cost effective than LNG in 2050 as shown in Figure 3.1-19. Electricity emerges as the most cost effective option with LCOE primary at around 18 €/MWh and along with complementary costs of storage

and other system components, total LCOE is around 29 €/MWh in 2050. Hydrogen (H₂) fuel costs decline to be more cost competitive than fossil fuels, about 50 €/MWh in 2050, while liquid H₂ is about 58 €/MWh. CO₂ from DAC is a critical component for producing synthetic fuels and is at around 31 €/tCO₂ in 2050, using waste heat, as shown in Figure 3.1-19. A methodological upgrade has resulted in higher costs of FT-fuels of around 4 €/MWh by 2050, which builds a slightly less favourable case for renewable powered synthetic fuels. However, this has little impact on the overall structural results, as presented in this study, but will enable more accurate estimations in future research.

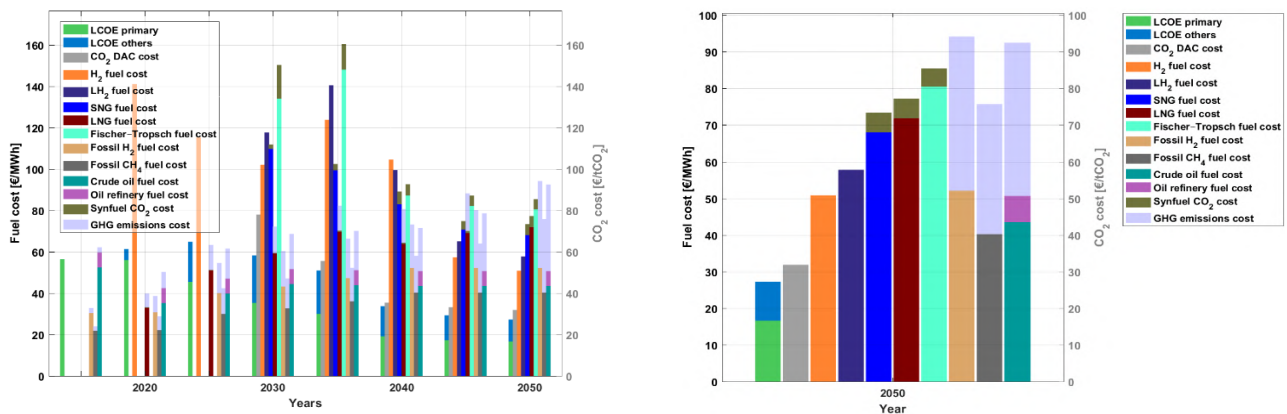

Figure 3.1-19: Global – Fuel costs for the transport sector during the energy transition from 2015 to 2050 (left) and fuel costs in 2050 (right).

The final transport energy costs vary between €1900-2300 billion annually through the transition, as shown in Figure 3.1-20. Road transport forms a major share of the costs in the initial years up to 2030. Beyond 2030, aviation and marine transport dominate the share of costs, as road transport costs decline through the transition with very high levels of direct electrification. Whereas, the rail and marine transport costs remain more steady through the transition. The total annual energy costs for transport are in the range of €1900-2300 billion through the transition period with a decline from around €2100 billion in 2015 to about €1900 billion by 2050, as shown in Figure 3.1-20. Furthermore, annual system costs transit from being heavily dominated by fuel costs in 2015 to a very diverse

share of costs across various technologies for electricity, synthetic fuels and sustainable biofuel production by 2050, as highlighted in Figure 3.1-20. Moreover, a high rate of electrification across the sector stabilises annual system costs, despite a growth in transport demand and eventually annual system costs benefit from the massive gains in energy efficiency by 2050. The difference in annual final transport energy and system costs is predominantly due to additional aspects of the system beyond 2040, as FT units produce naphtha as a by-product, that adds to the overall system costs. The cost for naphtha is allocated to the industry sector as input for the chemical industry, since it is a valuable feedstock there.

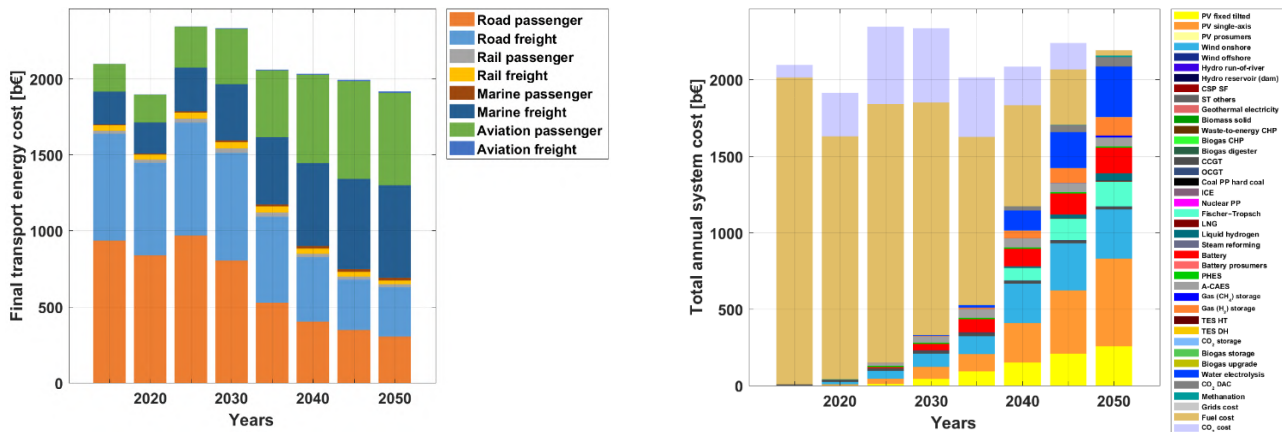

Figure 3.1-20: Global – Final transport energy costs based on mode of transport (left) and source of energy (right) during the energy transition from 2015 to 2050.

The final transport passenger costs decline from around 0.10 €/p-km in 2015 to 0.06 €/p-km by 2050, as shown in Figure 3.1-21. In addition, final transport passenger costs for road transport decline through the transition. Whereas, for rail, marine and aviation there is a marginal decrease in final transport passenger costs. Similarly, final

transport freight costs decline from nearly 0.07 €/t-km in 2015 to 0.02 €/t-km by 2050, as shown in Figure 3.1-21. The final freight costs in the case of road decline through the transition, whereas it increases slightly for aviation and remains stable for rail and marine.

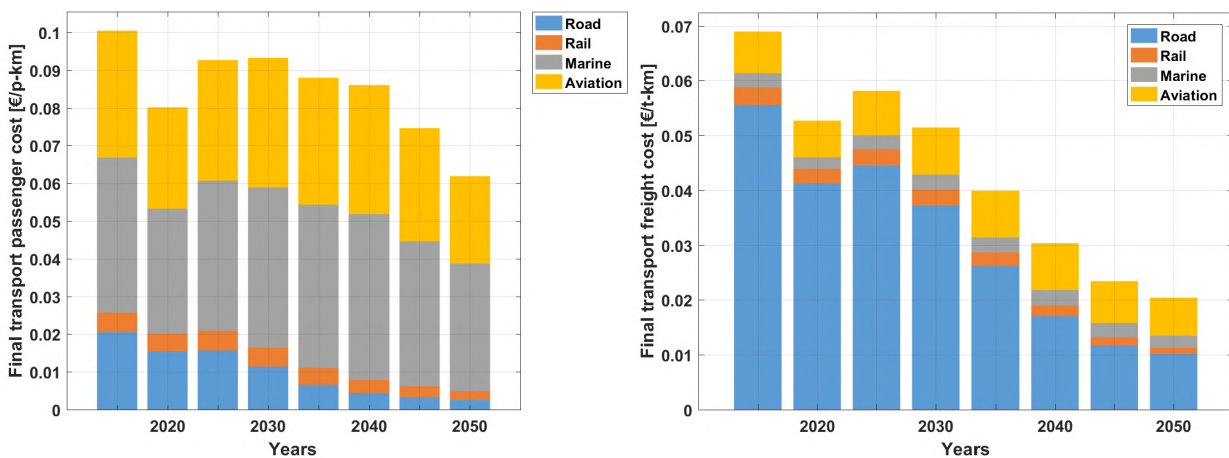

Figure 3.1-21: Global – Final transport passenger cost (left) and final transport freight cost (right) during the energy transition from 2015 to 2050.

Desalination

Desalination demand varies significantly across the different regions of the world, which is quite low in the initial periods of the transition. However, with increased levels of water stress expected across many regions the demand for desalinated water increases beyond 2030. Therefore, the installed capacities of power generation for the desalination sector increase from just around 22 GW in 2015 to

around 4,000 GW by 2050, as shown in Figure 3.1-22. Solar PV and wind comprise the majority of installed capacities from 2030 until 2050. Primary electricity generation to meet the desalination demand in the initial period of the transition is from fossil gas up to 2030, beyond which solar PV and wind dominate the supply as highlighted in Figure 3.1-22. In 2050, around 6700 TWh of electricity is generated from solar PV and wind energy to meet the global desalination demand.

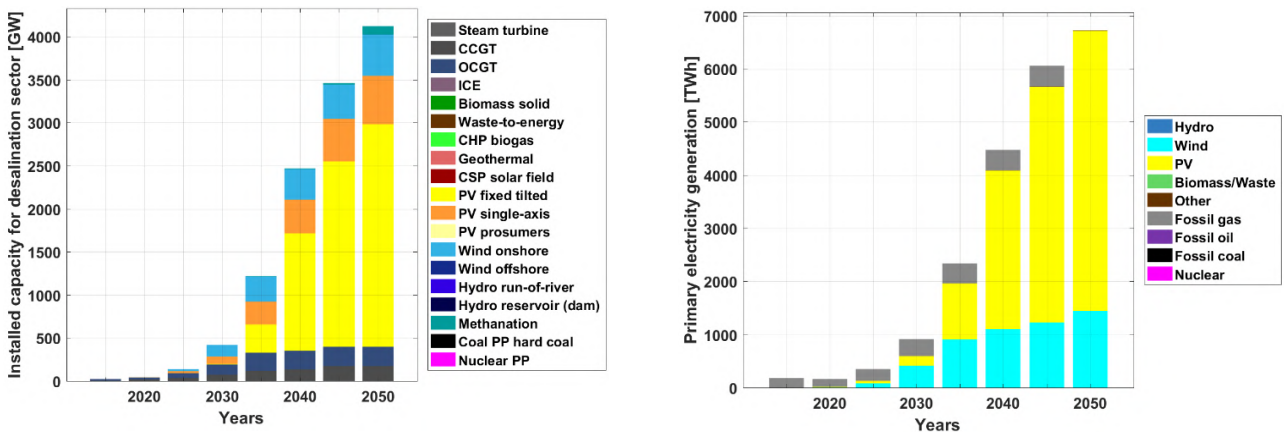

Figure 3.1-22: Global – Technology-wise installed capacities for the desalination sector (left) and primary electricity generation for the desalination sector (right) during the energy transition from 2015 to 2050 in Europe.

The installed storage capacity for desalination occurs mainly from 2035 onwards, with most of the capacities added in the final five-year period until 2050, as shown in Figure 3.1-23. Gas comprises more than 95% of the 290 TWh installed storage

capacity in 2050, whereas batteries contribute the majority of the storage output, which reaches more than 2750 TWh_{el} by 2050 as shown in Figure 3.1-23.

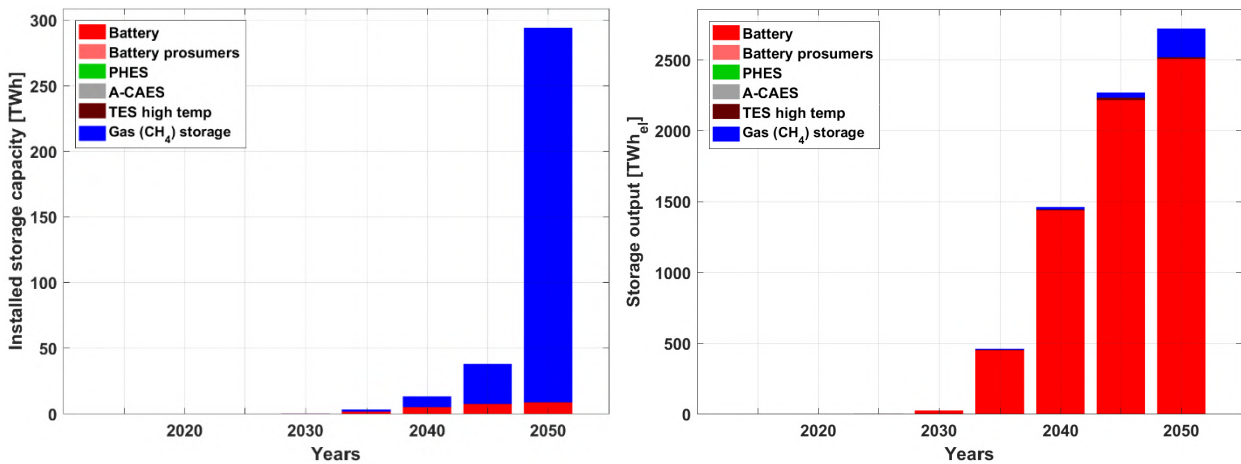

Figure 3.1-23: Global – Installed storage capacity (left) and storage output (right) during the energy transition from 2015 to 2050.

Investments in power generation for the desalination sector occur mainly from 2030 onwards, as shown in Figure 3.1-24. A majority of the investments are in solar PV, wind energy, and batteries, which reaches a high of around €750

billion in 2040. Despite the massive increase in demand, the LCOW remains quite stable through the transition from around 1.1 €/m³ in 2020 to over 1 €/m³ by 2050, as shown in Figure 3.1-24.

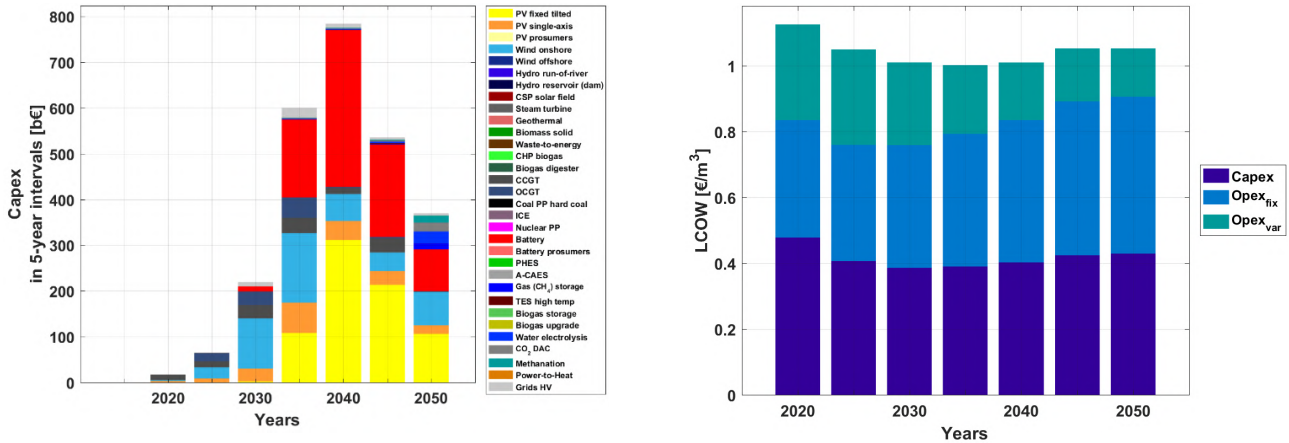

Figure 3.1-24: Global – Capital costs for five-year intervals (left) and levelised cost of water (right) during the energy transition from 2015 to 2050.

Regional Outlook

Electricity generation capacities are installed across the different regions of the world to satisfy the demand for power, heat, transport, and desalination up to 2050. Solar PV capacities are predominantly in the global south that have better solar resources through the year, while wind energy capacities are mainly in the northern regions that have much better wind conditions during most parts of the year, as shown in Figure 3.1-25. Overall, solar PV and wind capacities along with

some hydropower, bioenergy and geothermal capacities constitute the majority of installed capacities in 2050 across the world. Similarly, higher shares of solar PV generation happen in the southern regions, especially the Sun Belt countries and higher shares of wind energy are in the northern regions as highlighted in Figure 3.1-25. This also presents an opportunity for enhancing the complementarity of solar PV and wind energy with interconnections within regions as well as with inter-regional energy systems.

Regional electricity capacities

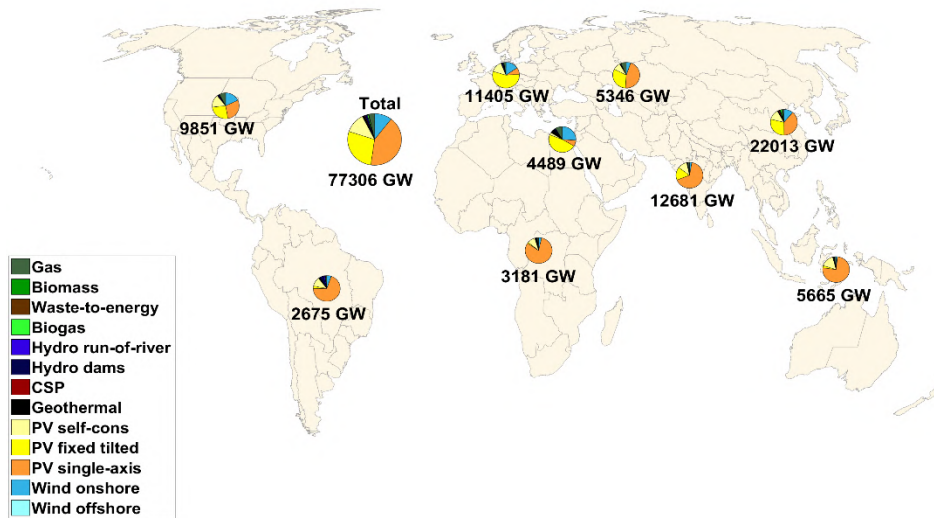

Regional electricity generation

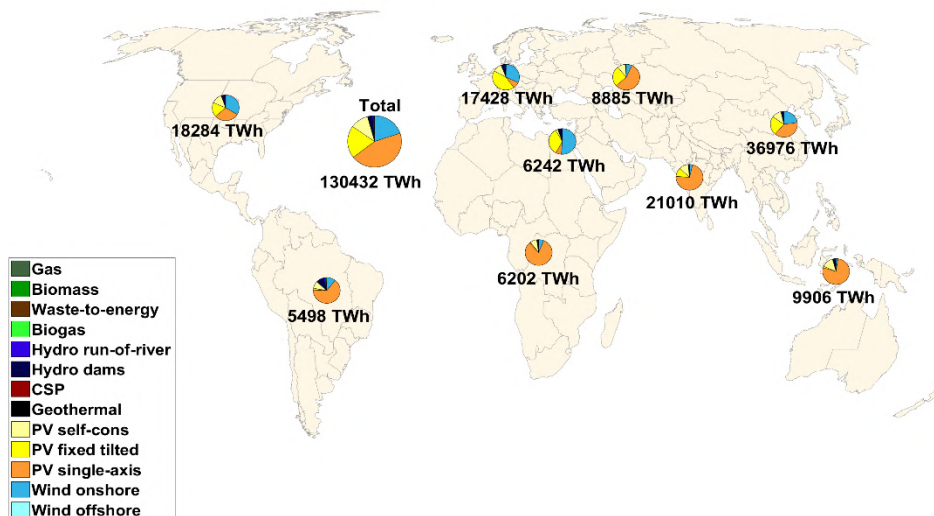

Figure 3.1-25: Global – Regional electricity generation capacities (top) and electricity generation (bottom) in 2050.

Solar PV capacities are well distributed across the different regions of the world and achieve a total installed capacity base of 63,380 GW in 2050. Moreover, there are higher capacities mostly in Sun Belt countries and high population growth centres as shown in Figure 3.1-26. Whereas, wind energy

capacities achieve a total installed capacity base of 8130 GW in 2050 and are predominantly from latitudes of 45° N and higher, which show a strong seasonality effect, i.e. parts of North America, Europe and Eurasia implying higher wind energy capacities. This can be observed in Figure 3.1-26.

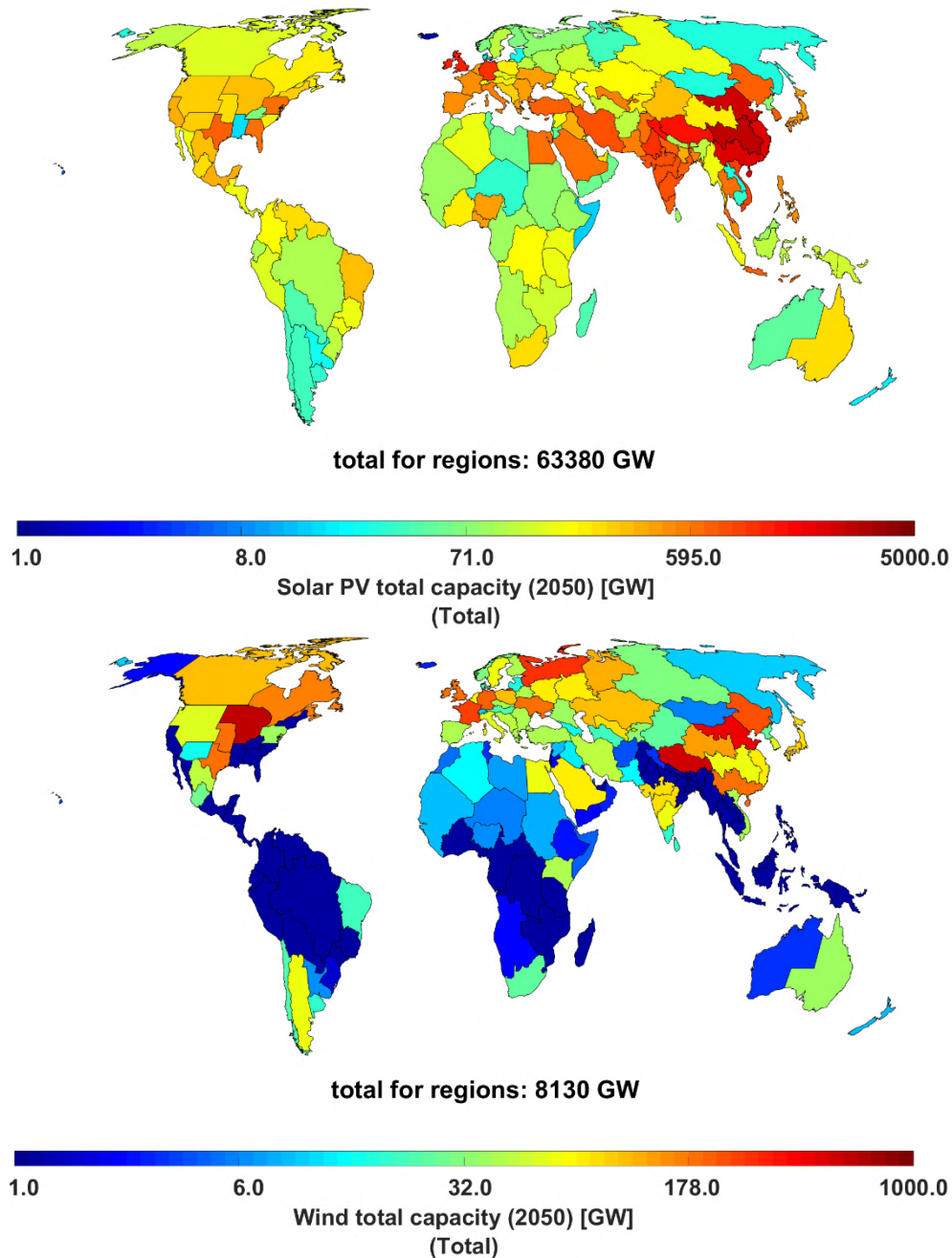

Figure 3.1-26: Global – Regional variation of electricity generation capacities of solar PV (top) and wind energy (bottom) in 2050.

The electricity generation across the power, heat, transport, and desalination sectors in the world are predominantly from solar PV and wind in 2050. Solar PV, which supplies an average of around 76% of electricity generation across the world, is more common in the southern regions of the world, as shown in Figure 3.1-27. While wind energy, which contributes an average of nearly 20% of electricity

generation across the world, is mainly found in the northern regions of the world, as shown in Figure 3.1-27. Overall, solar PV and wind energy generate most of the electricity needed across the world by 2050, which is around 96% of total electricity generation to meet the demands across the power, heat, transport and desalination sectors.

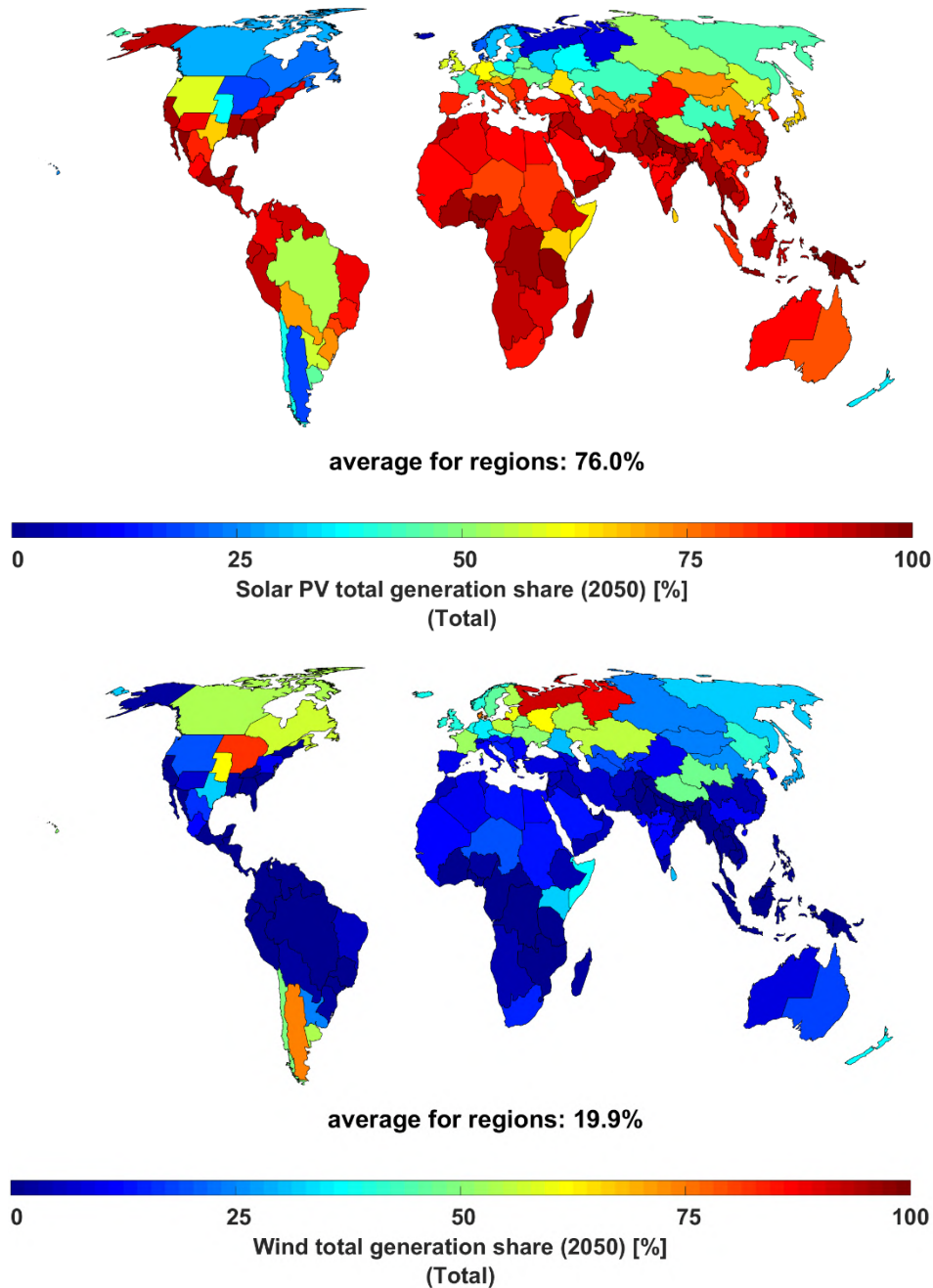
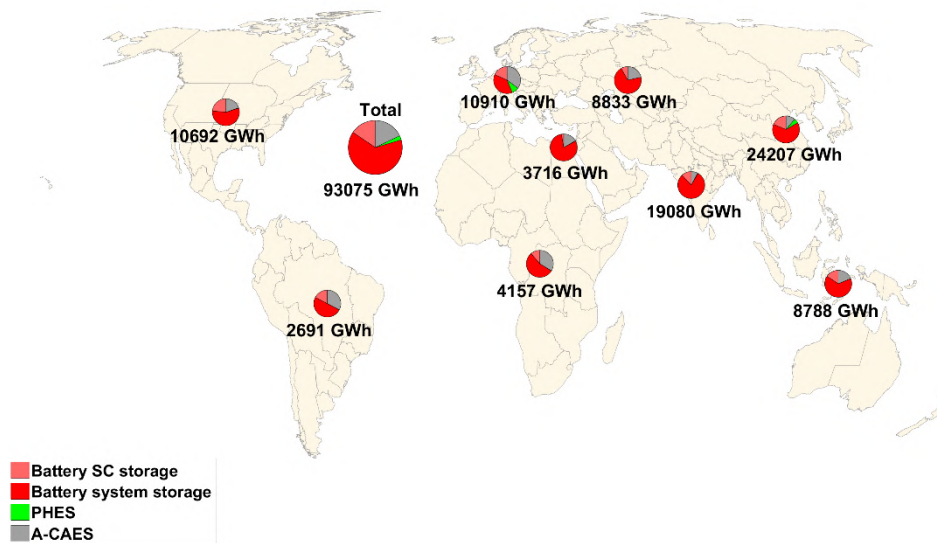

Figure 3.1-27: Global – Regional variation of electricity generation shares of solar PV (top) and wind energy (bottom) in 2050.

Utility-scale and prosumer batteries contribute a major share of electricity storage capacities, with some shares of PHEs and A-CAES by 2050, as shown in Figure 3.1-28. Storage capacities are much higher in the global south, to complement higher shares of installed solar PV capacities, compared to the northern regions. Batteries, both prosumers and utility-scale, deliver the largest shares of output by 2050, as shown in Figure 3.1-

28. In addition, the share of output from prosumer batteries is relatively higher in the northern regions especially Europe and North America, whereas utility-scale batteries deliver higher outputs in the southern regions of MENA, SAARC and Northeast Asia. While, PHEs and A-CAES contribute complementary shares of electricity storage output through the transition, across the different regions of world.

Regional electricity storage capacities



Regional electricity storage annual generation

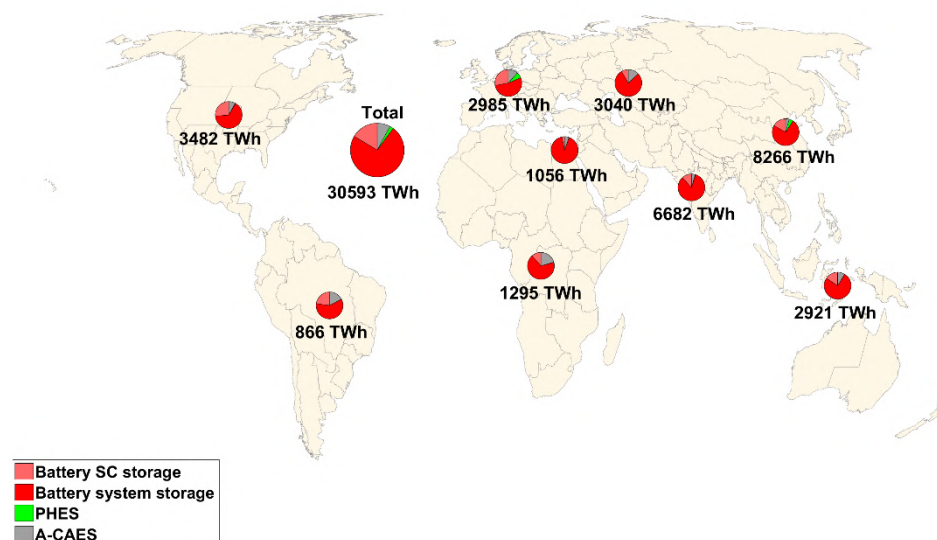

Figure 3.1-28: Global – Regional electricity storage capacities (top) and electricity storage annual throughput (bottom) in 2050.

The storage output across the power and heat sectors of the world is predominantly from batteries (both utility-scale and prosumers) and some synthetic natural gas supply in 2050. Batteries, which supply an average of 32.5% of the electricity storage output across the world, are more predominant in the southern regions mainly in the Sun Belt countries, as shown in Figure 3.1-29.

Synthetic natural gas, which supplies an average of 0.2% of the total electricity demand across the world, is predominant in the northern and Eurasia regions with higher seasonality effects, as shown in Figure 3.1-29. This is complemented with a supply share of storage from biomethane of around 0.1% in 2050 across the world.

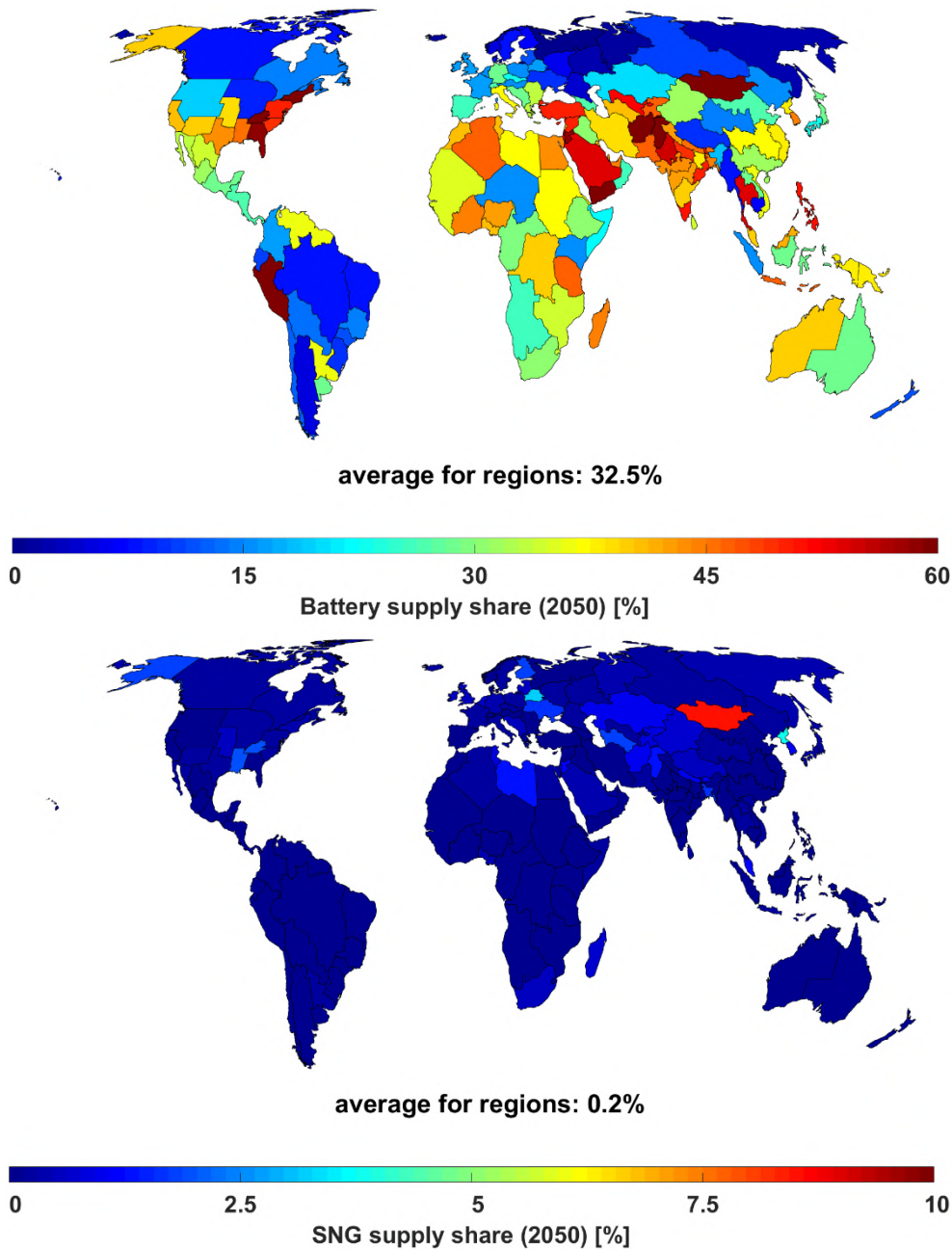

Figure 3.1-29: Global – Regional variation of storage supply shares of batteries (top) and synthetic natural gas (bottom) in 2050.

Socio-economic Benefits

Development of renewable energy has emerged as a true multi-beneficial phenomenon, which enables climate change mitigation, drives economic growth, creates local value based on technology development, production, installation, and maintenance, helps to increase energy access in a timely manner, and to reduce resource conflicts in water-stressed regions of the world.

Greenhouse Gas Emissions

The results of the global transition towards a 100% renewable energy system indicate a sharp decline in global greenhouse gas (GHG) emissions until 2050, reaching zero GHG emissions by 2050 across the power, heat, transport, and desalination sectors

around the world as shown in Figure 3.1-30. The power sector undergoes a deep decarbonisation by 2030, whereas for the heat and transport sectors this occurs mostly between 2030 and 2050. Moreover, the remaining cumulative GHG emissions comprise around 422 GtCO_{2eq} from 2018 to 2050. Therefore, the energy transition pathway is in adherence to the ambitious Paris Agreement target of 1.5°C.

Global GHG emissions from the power sector decline through the transition from over 11,000 MtCO₂ eq./a in 2015 to zero by 2050, as shown in Figure 3.1-31. Similarly, GHG emissions from the heat sector decline through the transition from over 9,300 MtCO₂ eq./a in 2015 to zero by 2050, as shown in Figure 3.1-31.

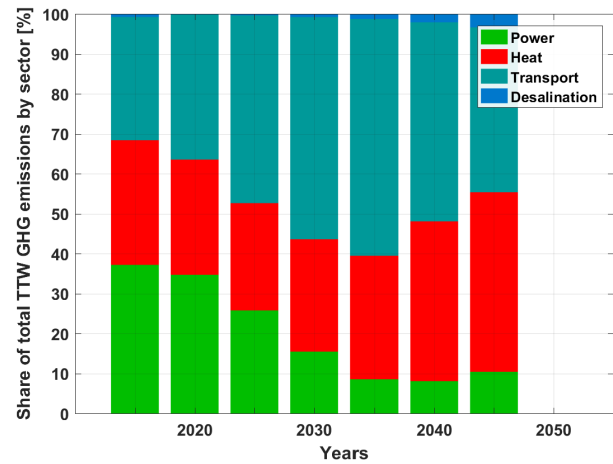
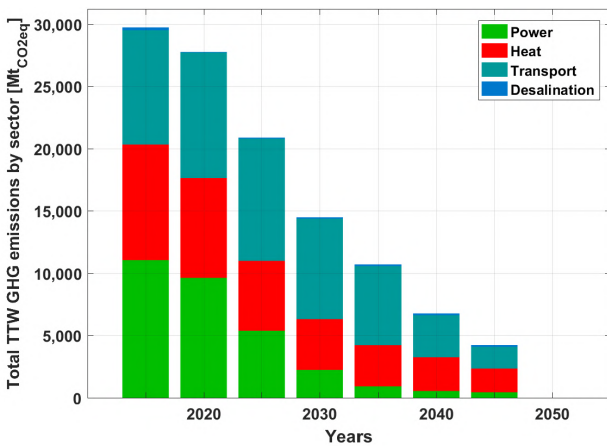

Figure 3.1-30: Global – Sector-wise GHG emissions (left) and the share of GHG emissions of different sectors (right) during the energy transition from 2015 to 2050. Tank to Wheel (TTW) considers GHG emissions from readily available fuels and does not consider GHG emissions from the upstream production and delivery of fuels.

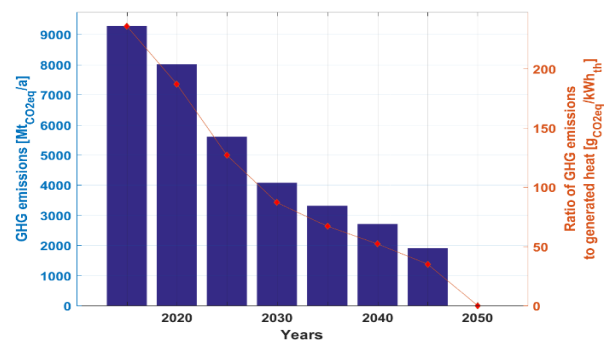
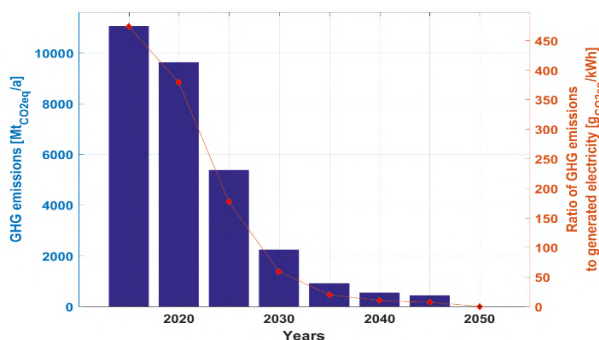

Figure 3.1-31: Global – GHG emissions in the power sector (left) and GHG emissions in the heat sector (right) during the energy transition from 2015 to 2050.

Global GHG emissions from the transport sector decline through the transition from over 9,000 MtCO₂ eq./a in 2015 to zero by 2050, as shown in Figure 3.1-32. In the initial periods, GHG emissions still increase, whereas a fast electrification of the road transport mode and parallel rise in renewable electricity lead to a massive GHG emissions reduction from the 2020s onwards. The massive

scale-up of synthetic fuels from 2040 onwards further defossilates the marine and aviation transport modes. Similarly, GHG emissions from the desalination sector, which are much lower than those of the other sectors, increase through the transition from over 55 MtCO₂ eq./a in 2015 to 140 MtCO₂ eq./a in 2040 and then drop to zero by 2050, also visible in Figure 3.1-32.

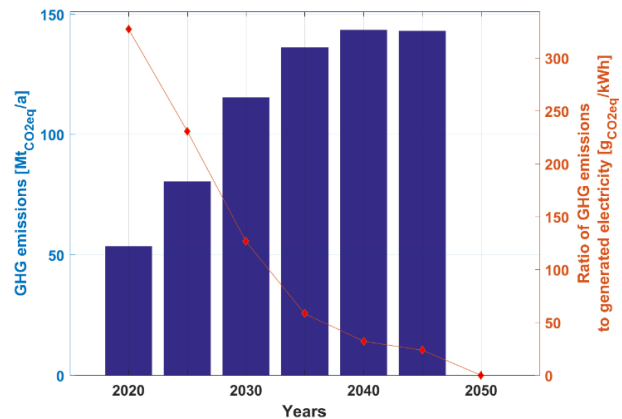
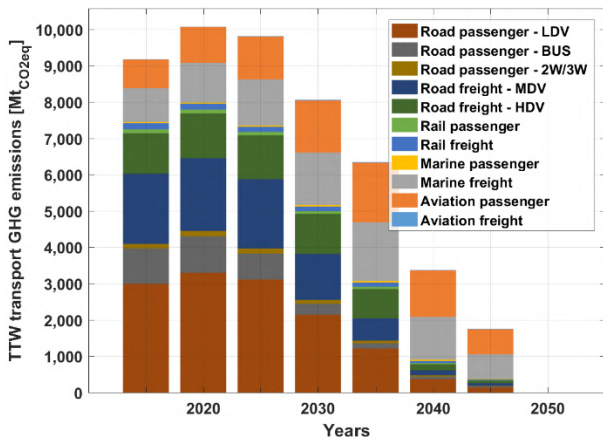

Figure 3.1-32: Global – GHG emissions in the transport sector (left) and GHG emissions in the desalination sector (right) during the energy transition from 2015 to 2050. Tank to Wheel (TTW) considers GHG emissions from readily available fuels and does not consider GHG emissions from the upstream production and delivery of fuels.

Jobs in the Global Power Sector

Job creation across the world to meet just the electricity demand arising from the transition in the power sector (thus excluding electricity demand from the heat, transport, and desalination sectors) is estimated utilising the methodology presented in Ram et al.⁵⁹. With the rapid ramp-up of installed capacities, a growing share of renewable power generation technologies are observed to compensate for the phasing out of nuclear power production as well as for the continually reducing number of fossil fuel power plants globally. This strong growth in the renewable energy sector leads to an increase of around 70% more direct power sector jobs by 2030, and the overall jobs created are 1.5 times as high in 2050, compared to 2015. Jobs created continue to rise to reach around 34 million direct energy jobs by 2030. Beyond this point, they decline to around the 30 million range and then

steadily increase to nearly 35 million by 2050 as shown in Figure 3.1-33. Solar PV, batteries and wind energy are the major job creating technologies during the entire transition. In the case of wind energy, around 7.3 million jobs are created in the period from 2020 to 2030, beyond that, as solar PV becomes more cost effective they drive majority of the installations until 2050 and jobs in the wind sector are stabilised. While, hydropower and bioenergy create a stable share of jobs through the transition period. Solar PV is observed to replace coal as the major job creating energy resource, with around 64% of total jobs by 2050, as compared to just 10% of total jobs in 2015. Additionally, it is well complemented by battery storage creating around 13% of total jobs by 2050. Whereas, jobs in the coal, gas and nuclear power sectors are observed to decline rapidly as shown in Figure 3.1-33.

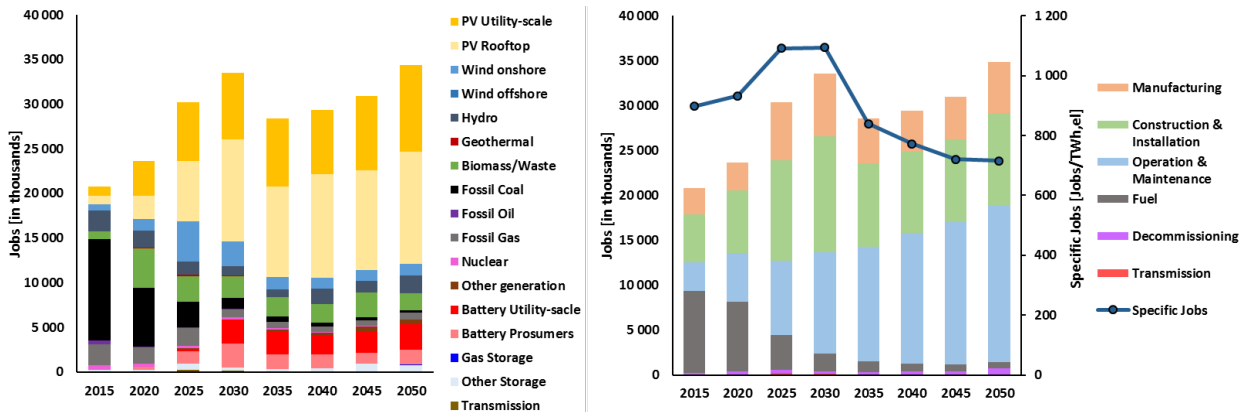

Figure 3.1-33: Global – Jobs created by various power generation and storage technologies (left) and jobs created based on different categories with the development of electricity demand specific jobs (right) during the energy transition from 2015 to 2050.

A category-wise classification of jobs in manufacturing, construction and installation, operation and maintenance, fuel supply, decommissioning and transmission created during the energy transition is shown in Figure 3.1-33. Fuel sector jobs are set to decline from 44% of the total jobs in 2015 to just around 2% of the total jobs by 2050 as fossil fuels and nuclear power capacities decline. On the other hand, it can be observed that operation and maintenance jobs have the most significant increase in the share of the total jobs created from 15% in 2015 to 50% by 2050. This indicates that the transition towards a 100% renewable power system enables creation of more

stable jobs, which can contribute to stable economic growth of countries mainly in the developing regions of the world and provide a means of tackling youth unemployment⁶¹. In many parts of the world, this could be a catalyst to improve social wellbeing as well as political stability⁶². Furthermore, Figure 3.1-33 also illustrates the development of the electricity demand specific jobs, which remain quite stable through the transition period. With 897 jobs/TWh_{el} in 2015 and rising up to 1091 jobs/TWh_{el} in 2030 due to a large share of investments during this period, beyond 2030 it declines steadily to around 715 jobs/TWh_{el} in 2050.

3.2. Europe

Europe is one of the major economic centres of the world with an 18% share of global GDP according to the International Monetary Fund (IMF) ⁶³. Population in Europe is 664 million in 2015 representing a share of 9% in world population, which is estimated to be 7% in 2050. In addition, Europe is amongst the biggest energy consumers across the world, with total electricity consumption of around 4,000 TWh in 2015, which is estimated to rise to around 5,400 TWh by 2050, as per the estimates of the International Energy Agency (IEA) ⁴⁷. Europe has been at the forefront of the global energy transition with about 37% of installed power capacity and nearly 30% of electricity generation from renewables, according to statistics from the European Commission ⁶⁴. Moreover, the European Commission has proposed a long-term strategy to confirm Europe's commitment to lead global climate action and present a vision that can lead to

achieving net-zero GHG emissions by 2050 through a socially fair transition in a cost-efficient manner ⁶⁵. In this context, the study shows that an energy transition to 100% renewable energy is feasible at every hour throughout the year and is more cost-effective than the existing system, which is largely based on fossil fuels and conventional energy production across Europe. The detailed results for the energy transition across Europe are available in a supplementary data file, the link for the file can be found in the Appendix.

Penetration of renewables is not just a matter of replacing hydrocarbons with zero-carbon sources of energy supply – it also represents a significant change in resource efficiency. This is illustrated by the overall electrification across the power, heat, transport, and desalination sectors as shown in Figure 3.2-1.

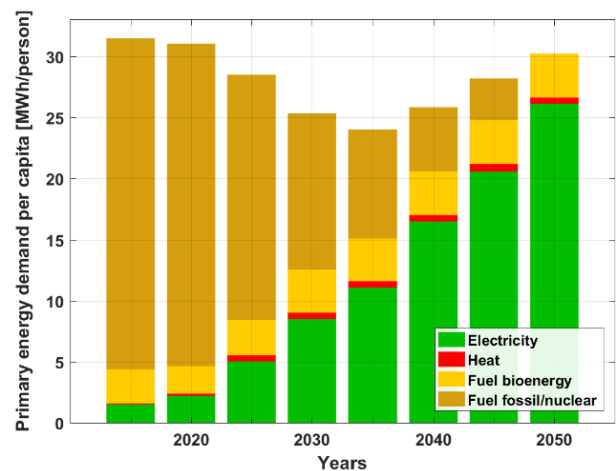
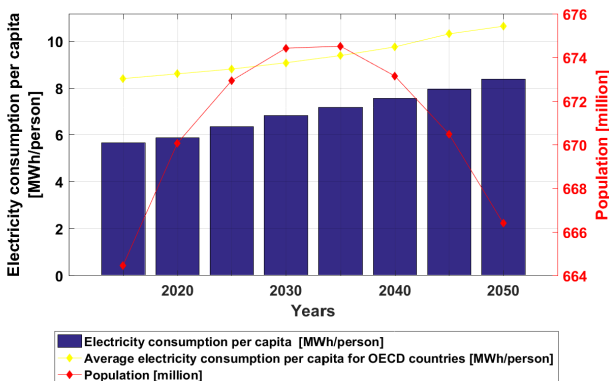
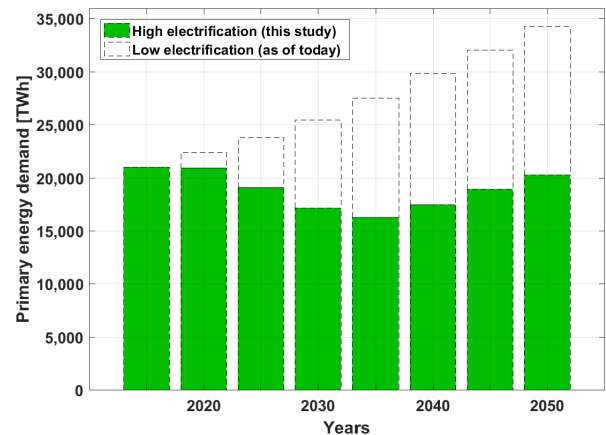
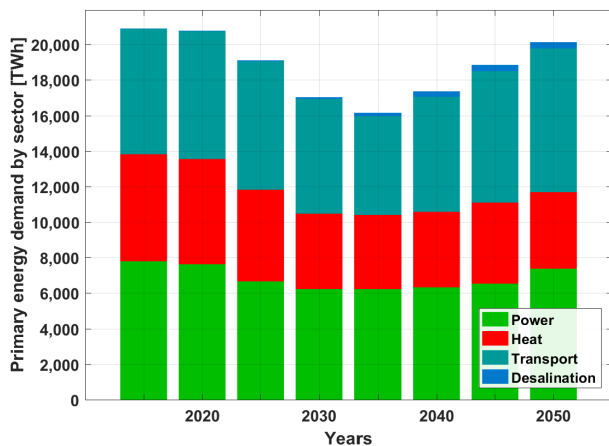

Figure 3.2-1: Europe – Primary energy demand sector-wise (top left), efficiency gain in primary energy demand (top right), electricity consumption per capita with population (bottom left) and primary energy demand per capita (bottom right) during the energy transition from 2015 to 2050.

The primary energy demand assuming high electrification, which is the basis for this study, decreases from 21,000 TWh in 2015 to around 16,000 TWh by 2035 and increases up to 20,000 TWh by 2050 as shown in Figure 3.2-1. On the contrary, with low electrification (adoption of current practices until 2050) the primary energy demand would reach around 34,000 TWh by 2050. The average per capita energy demand decreases from around 33 MWh/person in 2015 to 24 MWh/person by 2035 and increases up to nearly 30 MWh/person by 2050 as highlighted in Figure 3.2-1. The massive gain in energy efficiency is primarily due to a high level of electrification of more than 85%, resulting in reduction of around 14,000 TWh by 2050, in comparison to the continuation of current practices with low shares of electrification. However, a higher demand for industrial process heat, as well as space heating induced by growing building space per person, reduces the overall gains and contributes to an increase in energy demand in the later years of the transition, from

2035 to 2050. Additionally, a substantial demand from fuel conversion technologies arises beyond 2040, in producing renewable-based fuels for the transport sector across Europe.

Energy Supply

The electricity generation capacity across Europe satisfies demand from all energy sectors including power, heat, transport and desalination. The total installed capacity grows massively from about 1200 GW in 2015 to around 11,400 GW by 2050 as shown in Figure 3.2-2. In the initial period of the transition, a larger share of wind capacities are installed up to 2030, but in the later part of the transition solar PV dominates the shares of installed capacities reaching almost 8940 GW by 2050. On the other hand, the shares of fossil fuels and nuclear decline through the transition to zero by 2050. Some shares of gas remain, but the fuel switches from fossil-based gas to synthetic natural gas produced with renewable electricity and biomethane.

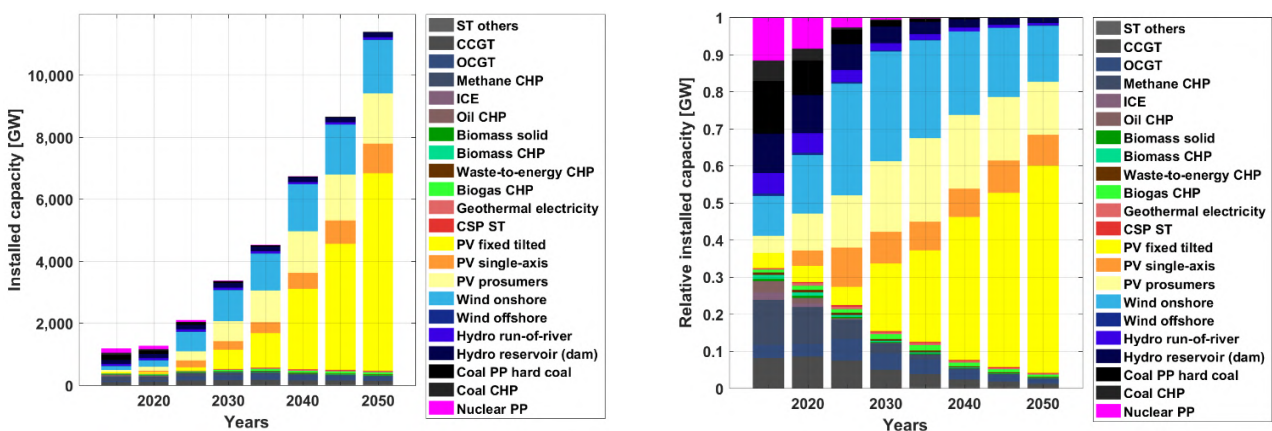

Figure 3.2-2: Europe – Technology-wise installed capacities (left) and technology-wise shares of installed capacities (right) during the energy transition from 2015 to 2050.

Electricity generation from the various technologies to cover the demand of power, heat, transport, and desalination sectors is shown in Figure 3.2-3. Solar PV supply increases through the transition from 29% in 2030 to about 62% by 2050, becoming the lowest cost energy source. Wind energy increases to 32% by 2030 and contributes a stable share of the mix up to 2050. In the heat sector, heat pumps play a significant role through the transition with a share of nearly 50% of heat generation by 2050 on

both the district and individual levels, as indicated in Figure 3.2-3. On the other hand, gas-based heating decreases through the transition from over 95% in 2015, to around 30% by 2050. Additionally, fossil fuel-based heating decreases through the transition period, as coal-based combined heat and power (CHP) and district heating (DH) is replaced by waste-to-energy CHP, biomass-based DH, and individual heating (IH).

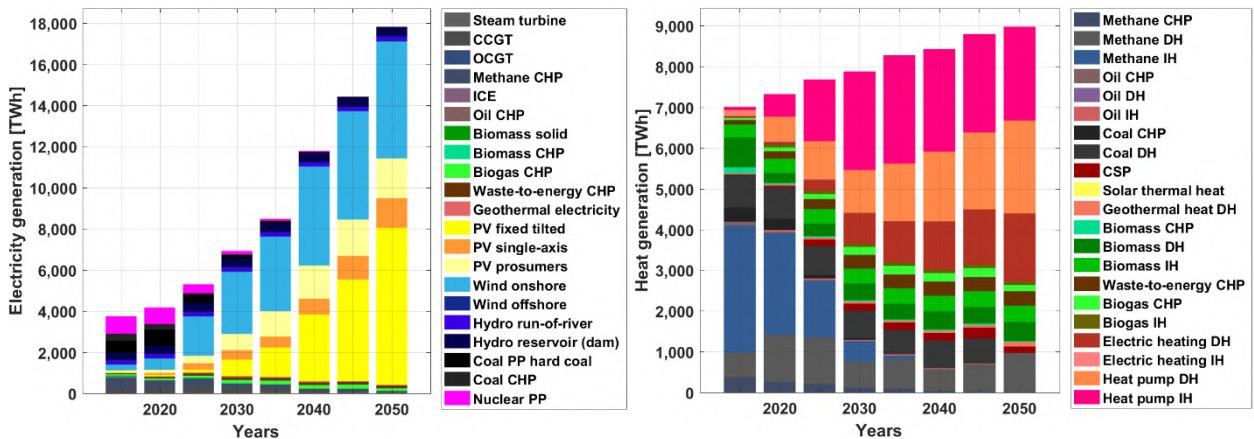

Figure 3.2-3: Europe – Technology-wise electricity generation (left) and technology-wise heat generation (right) during the energy transition from 2015 to 2050.

Energy Storage

Energy storage technologies play a critical role in enabling a secure energy supply throughout Europe, fully based on renewable energy across different sectors. As highlighted in Figure 3.2-4, storage output covers 18% of total electricity demand in 2050. The ratio of electricity demand covered by energy storage to electricity generation

increases significantly to around 13% by 2030 and remains around 11-13%. An additional 4% is covered by heat storage conversion to electricity by 2050. Batteries emerge as the most relevant electricity storage technology contributing about 83% of the total electricity storage output by 2050. Additionally, a significant share of gas storage is installed to provide seasonal storage primarily during the cold winter season across Europe.

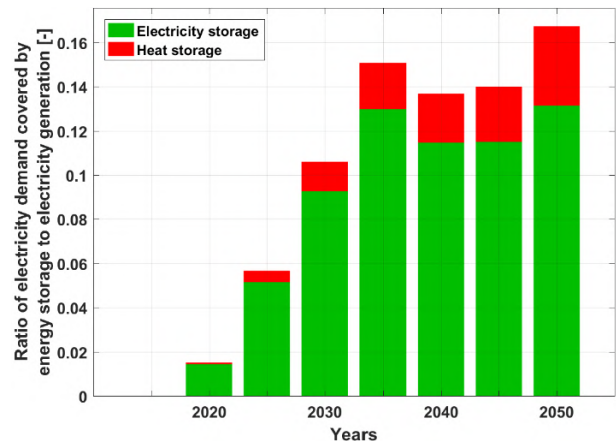
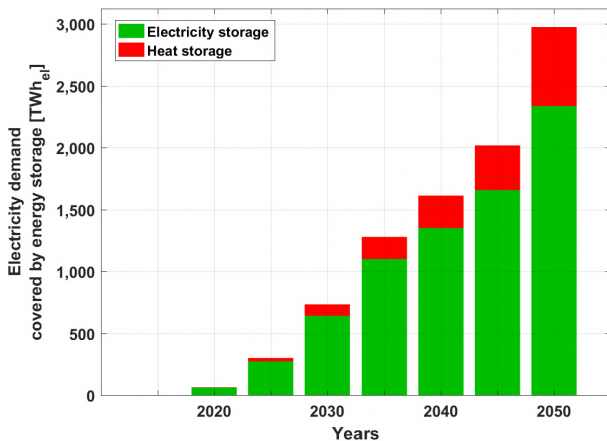

Figure 3.2-4: Europe – Electricity demand covered by energy storage (left) and ratio of electricity demand covered by different forms of energy storage (right) during the energy transition from 2015 to 2050.

Similarly, heat storage plays a vital role in ensuring that the heat demand is covered in all sectors. As indicated in Figure 3.2-5, storage output covers more than 30% of the total heat demand in 2050 and heat storage technologies are crucial to meet this demand. The ratio of heat demand covered by energy storage to heat generation increases substantially to almost 20% by 2050, also shown in Figure 3.2-5. Thermal energy storage (TES)

emerges as the most relevant heat storage technology with around 40-60% of heat storage output from 2030 until 2050. Furthermore, power-to-gas (PtG) contributes around 40% of heat storage output in 2050. As fossil fuel usage for heat generation is completely eliminated in the final 5-year period up to 2050, there is an increase in heat storage utilisation.

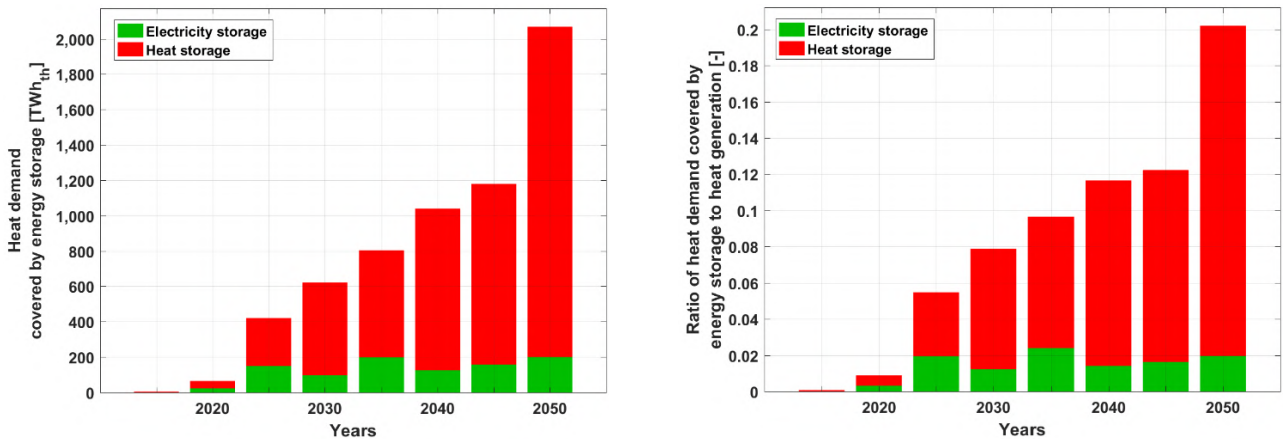

Figure 3.2-5: Europe – Heat demand covered by energy storage (left) and the ratio of heat demand covered by different forms of energy storage (right) during the energy transition from 2015 to 2050.

Costs and Investments

The total annual costs are in the range of €950-1,100 billion through the transition period and are well distributed across the major sectors of power, heat, and transport, as desalination demand in Europe is relatively smaller compared to other regions of the world. As indicated by Figure 3.2-6, power, heat, and transport costs are in the range of

around €300-350 billion through the transition. In addition, as indicated in Figure 3.2-6 CAPEX increases through the transition, as fuel costs decline. The steady increase in CAPEX-related energy system costs indicate that fuel imports and the respective negative impacts on trade balances will fade out through the transition. In addition, a low fuel import dependency will lead to a higher level of energy security across Europe.

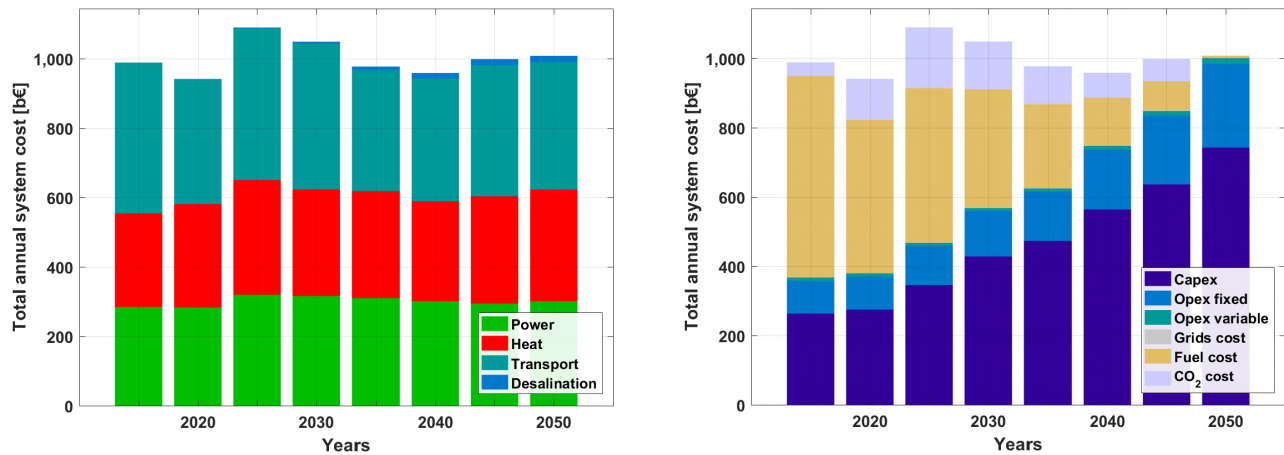

Figure 3.2-6: Europe – Annual system costs, sector-wise (left) and functionality-wise (right) during the energy transition from 2015 to 2050.

As increasing shares of power generation capacities are added globally, renewable energy sources on a levelised cost of energy basis become the lowest cost power generation source⁶⁶. As indicated in Figure 3.2-7, levelised cost of energy remains around €50-60/MWh and is increasingly dominated by capital costs as fuel costs continue to decline through the transition period, which could mean

increased self-reliance in terms of energy for Europe by 2050 as mentioned earlier. Capital costs are well spread across a range of technologies with major investments for PV, wind energy, batteries, heat pumps, and synthetic fuel conversion up to 2050, as shown in Figure 3.2-7. The cumulative investments are about €9,910 billion through the transition from 2016-2050.

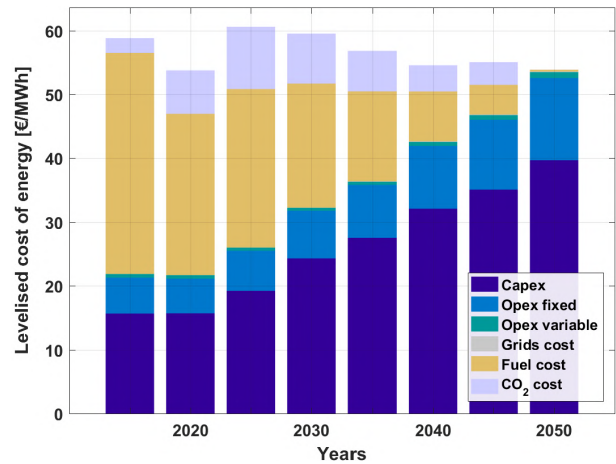
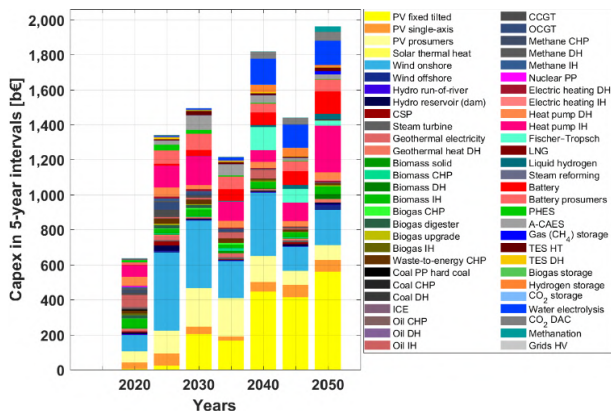

Figure 3.2-7: Europe – Capital costs for five-year intervals (left) and levelised cost of energy (right) during the energy transition from 2015 to 2050.

Outlook across Sectors

Different trends in the power, heat, transport, and desalination sectors across Europe emerge through the transition. As the sectors transition towards having higher shares of renewable energy, different technologies have vital roles in ensuring the stability of the energy system. A closer look at the individual sectors provides vital insights into the energy transition across Europe towards 100% renewable energy.

Power and Heat

The total installed power generation capacity

increases from nearly 1,100 GW in 2015 to around 6,000 GW by 2050, as shown in Figure 3.2-8. Across the power sector, solar PV with 4,400 GW and wind with 960 GW constitute the majority of installed capacities by 2050. In the heat sector, heat pumps, electric heating, and biomass-based heating constitute the majority of installed capacity by 2050, also shown in Figure 3.2-8. A significant increase in installed capacity of heat pumps and biomass-based heating occurs in the final five-year period leading up to 2050, as fossil fuels are completely eliminated from the energy system.

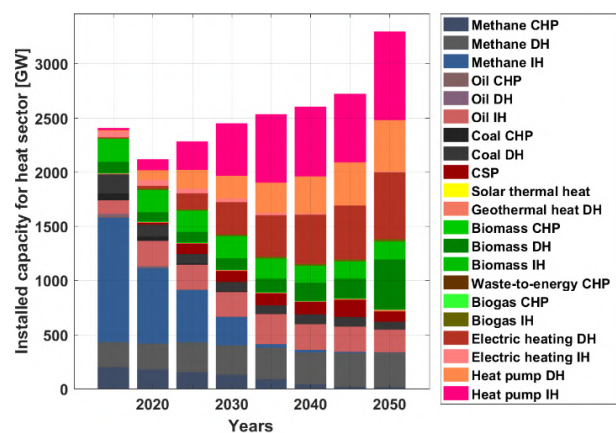
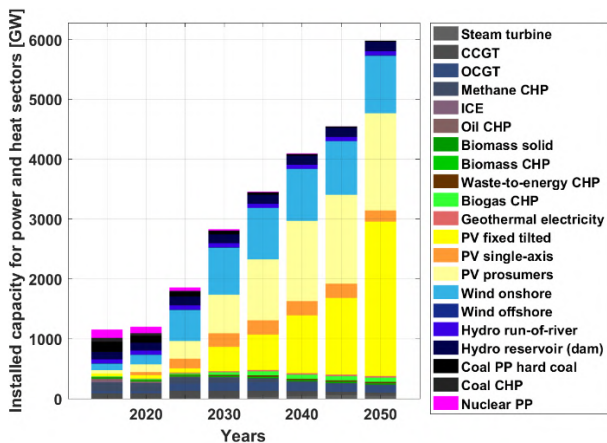

Figure 3.2-8: Europe – Technology-wise installed capacities for power (left) and heat (right) during the energy transition from 2015 to 2050.

The transition across Europe results in a power and heat sector dominated by fossil fuel and nuclear in 2015 moving towards a solar PV and wind energy dominated sector by 2050, with some hydropower and bioenergy as shown in Figure 3.2-9. The primary electricity generation increases from around 3,750 TWh in 2015 to around 9,500 TWh by

2050, which is primarily from PV and wind. Heat generation increases from around 7,000 TWh in 2015 to around 9,000 TWh by 2050, which is predominantly from heat pumps and electric heating with some biomass-based heating, also shown in Figure 3.2-9.

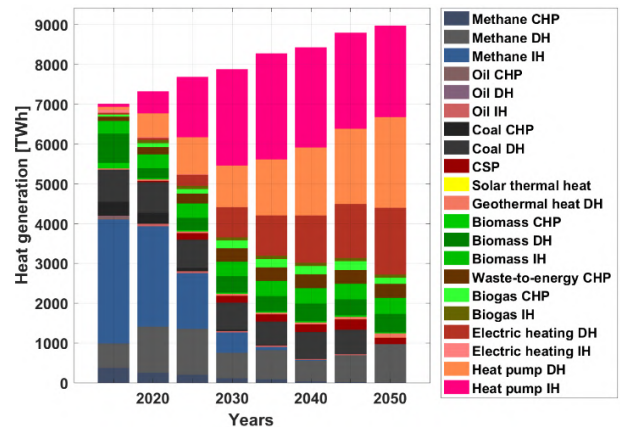
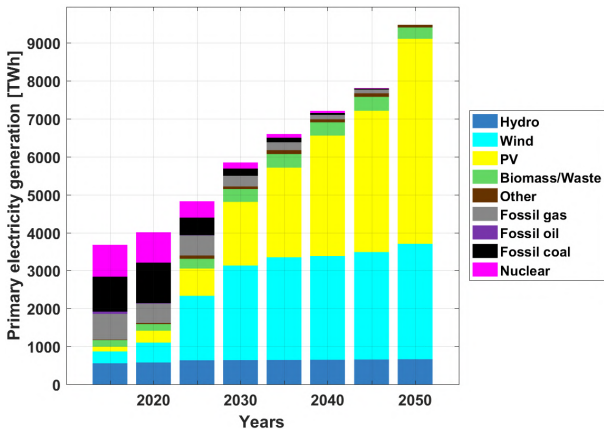

Figure 3.2-9: Europe – Primary electricity generation (left) and technology-wise heat generation (right) during the energy transition from 2015 to 2050.

The installed electricity storage capacity increases from just 0.3 TWh in 2015 to around 7.4 TWh by 2050, as shown in Figure 3.2-10. Utility-scale and prosumer batteries with some shares of PHEs and A-CAES are installed through the transition. The installed capacities of A-CAES are also a consequence of the modelling approach, which prioritises full domestic energy supply for all European regions. Other research indicates that interconnected European regions would require less electricity storage, and in particular A-CAES storage, which would mainly be substituted by the

flexibility offered with interconnected power transmission grids. The installed heat storage increases gradually until 2045 to around 25 TWh, but in the final five-year period up to 2050, a massive capacity of gas storage of nearly 225 TWh is added, as shown in Figure 3.2-10. This substantial capacity addition is mainly to provide seasonal storage across Europe covering the heat demand in the absence of fossil fuels. The present gas storage capacity across Europe is around 1,000 TWh, hence an even lesser amount of gas storage would be needed in the future.

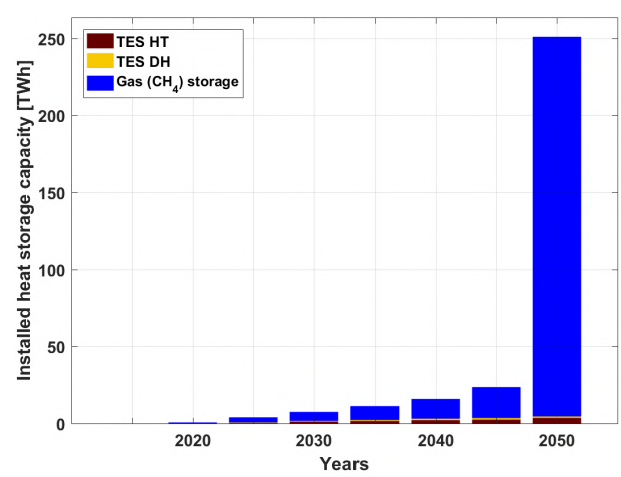
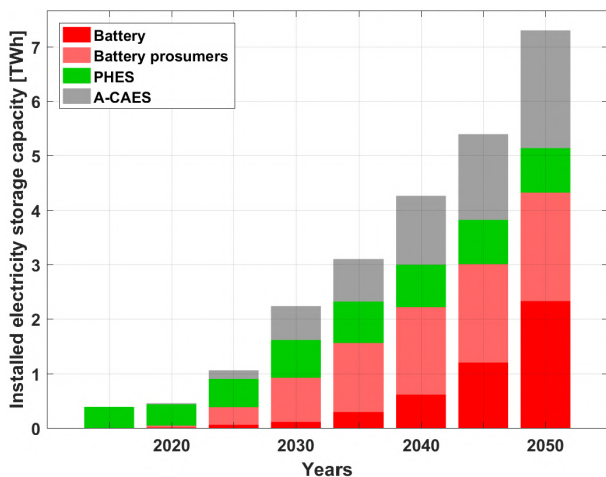

Figure 3.2-10: Europe – Installed electricity storage capacities (left) and heat storage capacities (right) during the energy transition from 2015 to 2050.

Utility-scale and prosumer batteries contribute a major share of electricity storage output with nearly 83% by 2050, as highlighted by Figure 3.2-11. In addition, PHES and A-CAES contribute through the transition. TES emerges as the most relevant heat storage technology with around 40-60% of heat

storage output from 2030 until 2050, also seen in Figure 3.2-11. Gas storage contributes around 40% of the heat storage output in 2050 covering predominantly seasonal demand, which is covered by fossil gas before 2050.

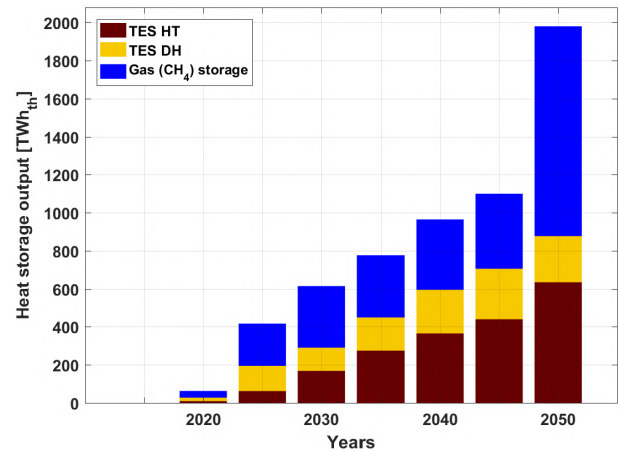
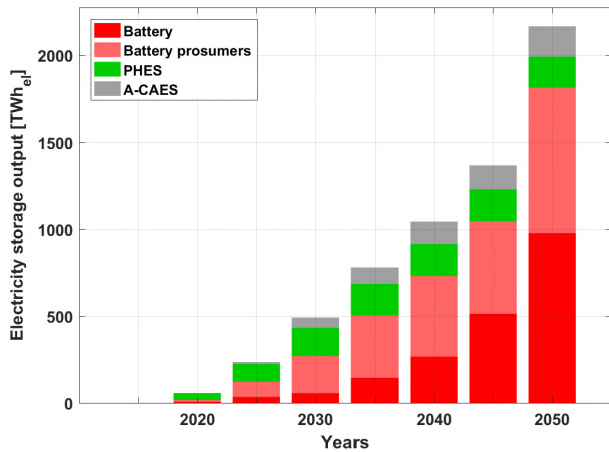

Figure 3.2-11: Europe – Electricity storage output (left) and heat storage output (right) during the energy transition from 2015 to 2050.

The LCOE of the power sector decreases substantially from around €80/MWh in 2015 to around €56/MWh by 2050, as shown in Figure 3.2-12. LCOE is predominantly comprised of CAPEX as fuel costs decline through the transition. The LCOH of the heat sector increases marginally from around €41/MWh in 2015 to around €47/MWh by 2030

and further declines to around €42/MWh by 2050, as shown in Figure 3.2-12. LCOH is predominantly comprised of CAPEX as fuel costs decline through the transition. Despite a substantial increase in heat demand across Europe, mainly driven by industrial process heat and increased space heating, the LCOH remains quite stable up to 2050.

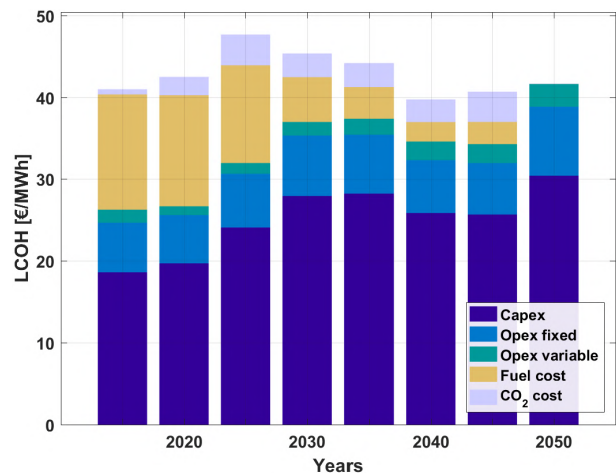
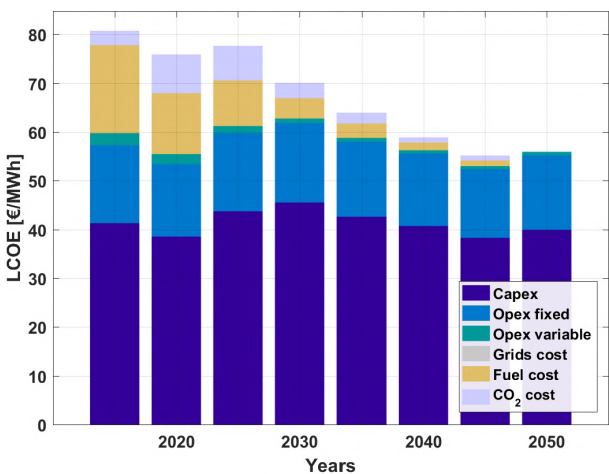

Figure 3.2-12: Europe – Levelised cost of electricity (left) and levelised cost of heat (right) during the energy transition from 2015 to 2050.

Investments are well spread across a range of power generation technologies with the majority share in wind energy up to 2030, beyond which solar PV dominates investments up to 2050, as shown in Figure 3.2-13. Investments in the heat sector are mainly in heat pumps and some shares in

biomass heating up to 2050, also shown in Figure 3.2-13. The steep increase in heat pump investments in the final five-year period until 2050 is mainly to cover the heat demand in the absence of fossil fuels as well as the lower costs of heat pumps by 2050.

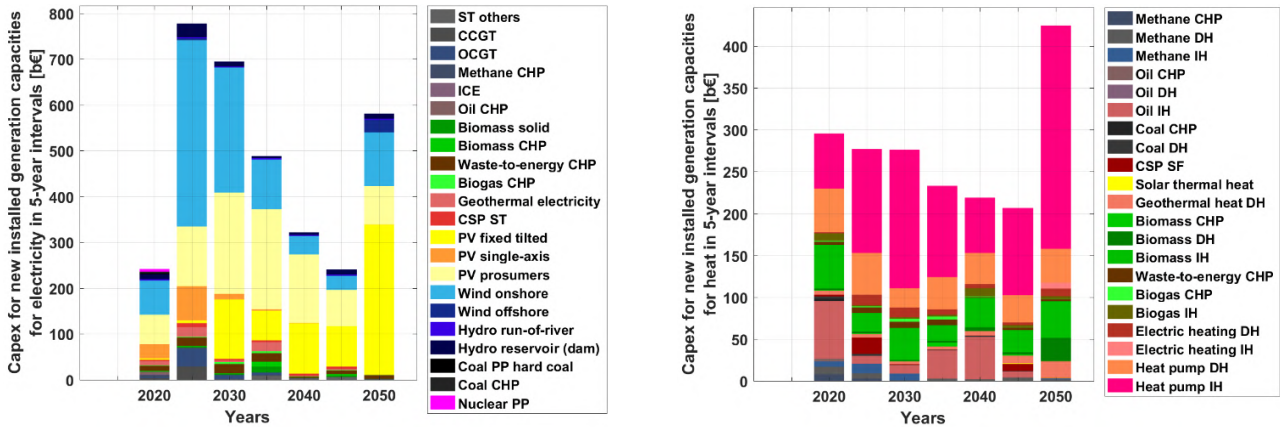

Figure 3.2-13: Europe – Capital costs of installed generation capacities in five-year intervals for electricity (left) and heat (right) during the energy transition from 2015 to 2050.

Transport

The primary energy demand of the transport sector across Europe is almost the same as the energy demand from the power sector at around 7,000 TWh in 2015. However, this demand declines through the transition to around 5,000 TWh, mainly due to the efficiency gains brought about by electrification of the sector as shown in Figure 3.2-14. Fossil fuel consumption in the transport sector across Europe is seen to decline through the transition from about 97% in 2015 to zero by 2050. On the other hand, liquid fuels produced by

renewable electricity contribute around 35% of final energy demand in 2050. In addition, hydrogen constitutes more than 25% of final energy demand in 2050. Sustainable biofuels produced from energy crops such as Jatropha could play a vital role, mainly in the transport sector in ensuring 100% renewable energy systems⁶⁰. Electrification of the transport sector creates an electricity demand of around 7,500 TWh_{el} by 2050. The massive demand for liquid fuels kicks in from 2040 onwards up until 2050, as indicated in Figure 3.2-14.

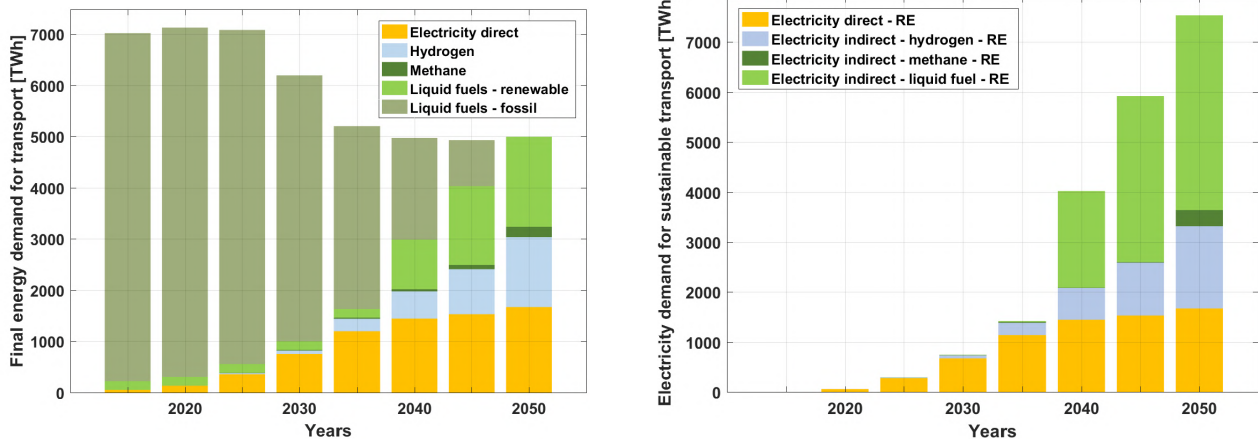

Figure 3.2-14: Europe – Final energy demand for transport (left) and electricity demand for sustainable transport (right) during the energy transition from 2015 to 2050.

Installed power generation capacity for the transport sector increases substantially through the transition to around 5,250 GW by 2050, as shown in Figure 3.2-15. Solar PV and wind form the majority share of the power generation capacity for the transport sector, as they are the lowest cost

energy sources by 2050. Similarly, electricity generation increases substantially up to almost 8,000 TWh by 2050 also to be seen in Figure 3.2-15. Solar PV and wind energy generate all the electricity required to meet the demand of the transport sector in 2050.

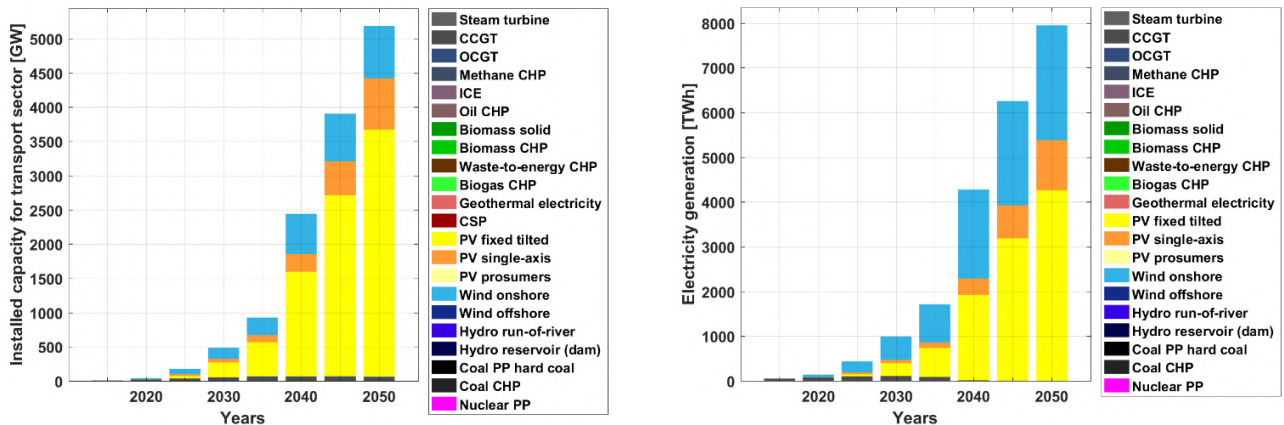

Figure 3.2-15: Europe – Transport sector installed power generation capacity (left) and electricity generation (right) during the energy transition from 2015 to 2050.

A critical aspect to complement the electrification of the transport sector is the installation of storage technologies. As seen in Figure 3.2-16, the installed capacities of electricity storage increase through the transition to around 3.3 TWh by 2050. The majority of installed capacities are utility-scale batteries and A-CAES. Similarly, electricity storage output increases through the transition to over 700 TWh_{el} by 2050 as shown in Figure 3.2-16. Utility-

scale batteries play a vital role as they contribute a major portion of the output through the transition, with over 500 TWh_{el} by 2050. The relatively low electricity storage of less than 10% of generated electricity for the transport sector is enabled by the flexible operation of batteries, water electrolyser units, and hydrogen buffer storage for synthetic fuel production.

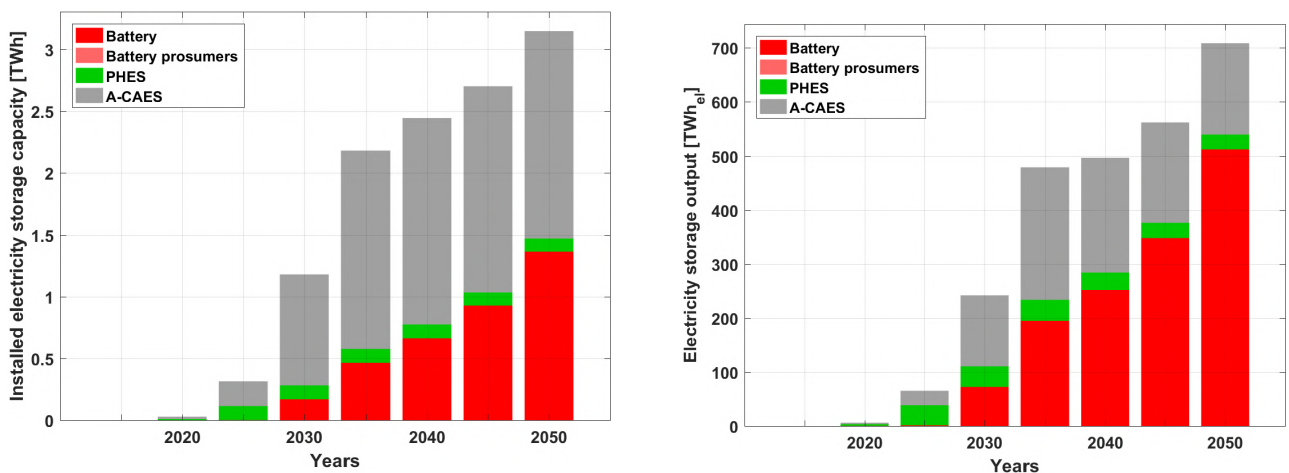

Figure 3.2-16: Europe – Transport sector installed electricity storage capacity (left) and electricity storage output (right) during the energy transition from 2015 to 2050.

An essential aspect in the transition of the transport sector towards higher electrification completely based on renewable energy is the production of synthetic fuels, hydrogen and sustainable biofuels. As indicated in Figure 3.2-17, the installed capacities of fuel conversion technologies increase substantially from 2040 onwards to over 2,300 GW by 2050. Water electrolysis forms the majority share

of fuel conversion capacities through the transition. Additionally, heat is needed during the production of synthetic fuels, mainly for energy-efficient CO₂ direct air capture, and this is enabled by managing process heat, which is otherwise not useable. Heat utilisation is in the range of 1,100 TWh_{th} by 2050, which is comprised of excess heat and recovered heat, as shown in Figure 3.2-17.

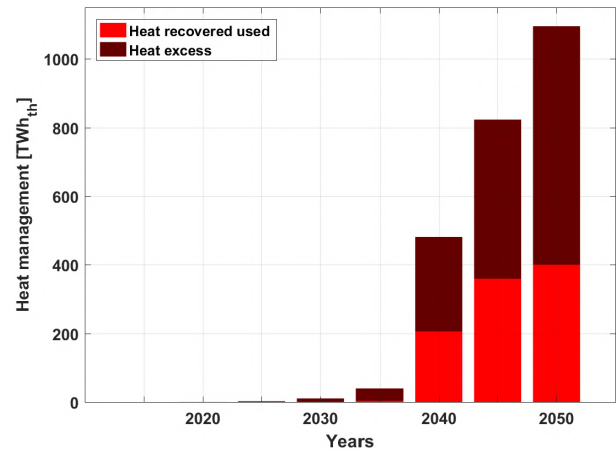
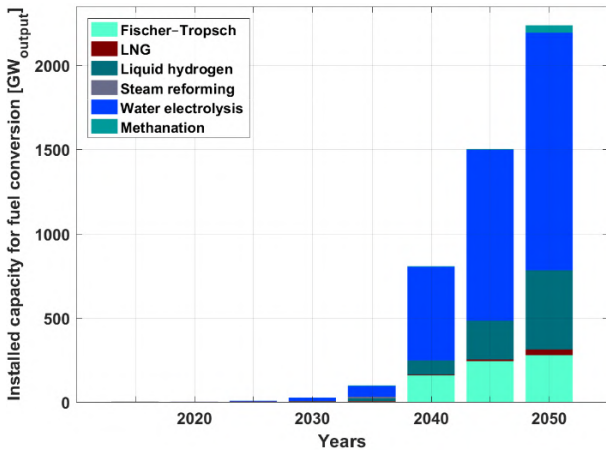

Figure 3.2-17: Europe – Transport sector installed capacity for fuel conversion (left) and heat management (right) during the energy transition from 2015 to 2050.

Similarly, gas storage is necessary in the production of synthetic fuels. As shown in Figure 3.2-18, the installed storage capacity for gas increases through the transition to around 13 TWh by 2050. Hydrogen storage is the major gas stored through the transition, with a minor share for methane gas in 2050. CO₂ storage and CO₂ direct air capture, which are vital in the production of synthetic fuels, are installed from 2040 onwards. The installed

capacity for CO₂ storage and CO₂ direct air capture increases up to around 390 MtCO₂ by 2050, as shown in Figure 3.2-18. The major share of installed storage capacity is CO₂ direct air capture, which is on an annual basis as compared to CO₂ storage. Despite having a lower storage capacity, CO₂ storage has a substantial utilisation and correspondingly higher throughput.

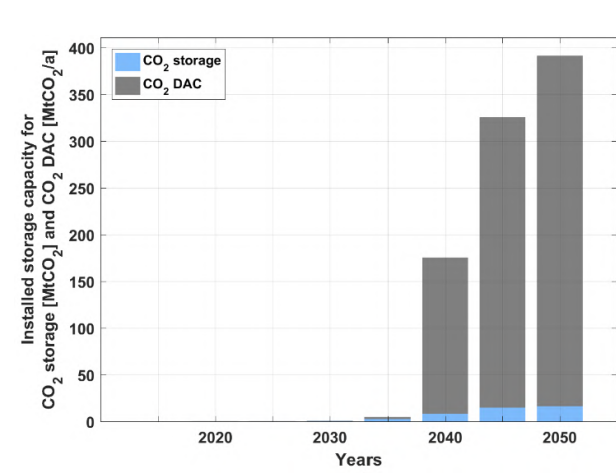
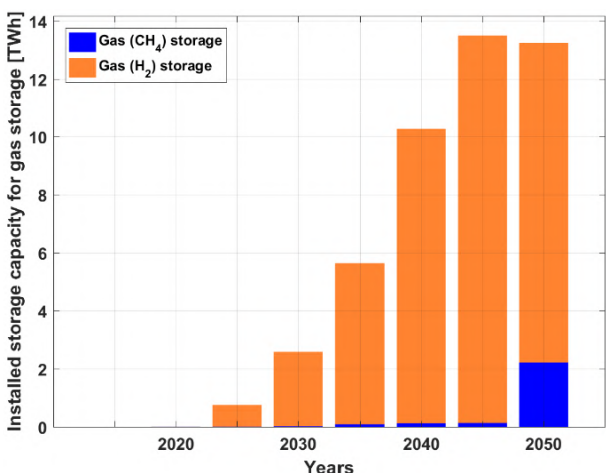

Figure 3.2-18: Europe – Transport sector installed capacity for gas (methane and hydrogen) storage (left) and CO₂ direct air capture and CO₂ storage (right) during the energy transition from 2015 to 2050.

Fuel costs are a deciding factor in the overall energy mix for the transport sector across Europe and their developing trends are highlighted in Figure 3.2-19. Fischer-Tropsch (FT) and Synthetic Natural Gas (SNG) fuel costs decline through the transition up to 2050. FT fuels are in the range of costs of fossil liquid fuels including GHG emissions costs, in the range of 90-100 €/MWh in 2050, SNG is more cost effective than LNG in 2050. Electricity emerges as the most cost effective option with

LCOE primary around 25 €/MWh and along with complementary costs of storage and other system components, total LCOE is around 32 €/MWh in 2050. Hydrogen (H₂) fuel costs decline to be more cost competitive than fossil fuels, in the range of 55 €/MWh in 2050, while liquid H₂ is in the range of 60 €/MWh. CO₂ from DAC is a critical component for synthetic fuels at around 33 €/MWh in 2050, using waste heat, as shown in Figure 3.2-19.

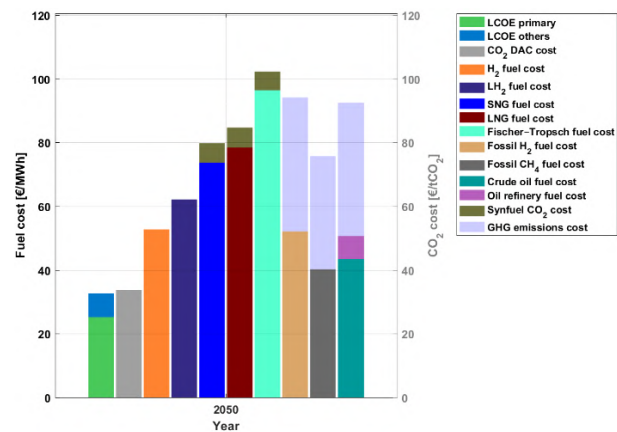
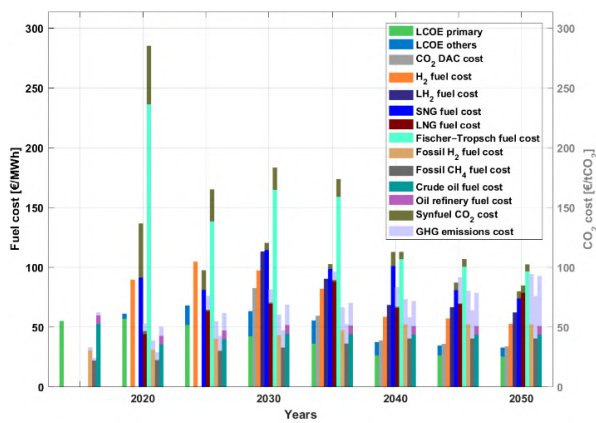

Figure 3.2-19: Europe – Fuel costs for the transport sector during the energy transition from 2015 to 2050 (left) and fuel costs in 2050 (right).

The total annual energy costs for transport are in the range of €300-450 billion through the transition period with a decline from around €430 billion in 2015 to about €330 billion by 2050, as shown in Figure 3.2-20. Furthermore, annual system costs transit from being heavily dominated by fuel costs in 2015 to a very diverse share of costs across various technologies for electricity, synthetic fuels and sustainable biofuel production by 2050, as

highlighted in Figure 3.2-20. The difference in annual final transport energy and system costs is predominantly due to additional aspects of the system beyond 2040, as FT units produce naphtha as a by-product, that adds to the overall system costs. The cost for naphtha is allocated to the industry sector as input for the chemical industry, since it is a valuable feedstock there.

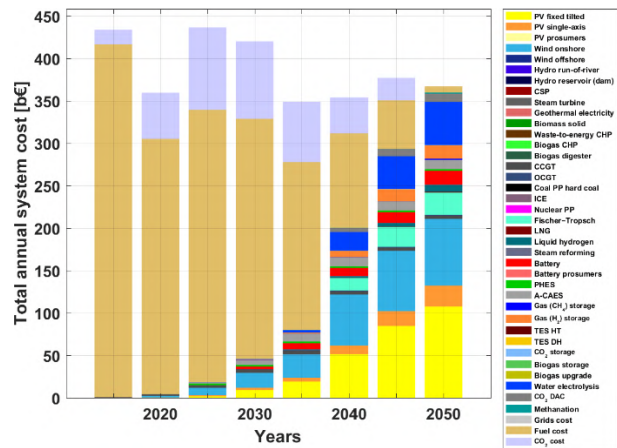
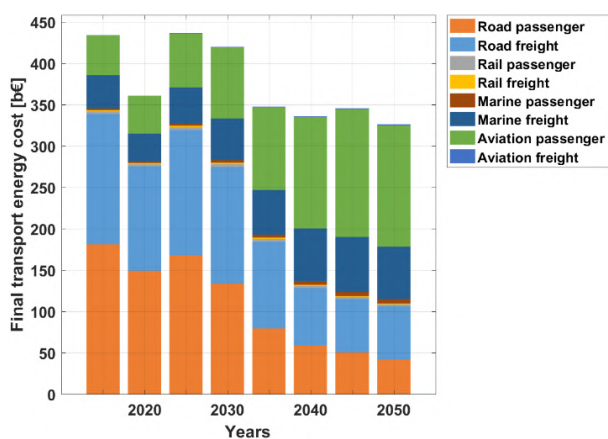

Figure 3.2-20: Europe – Final transport energy costs based on mode of transport (left) and source of energy (right) during the energy transition from 2015 to 2050.

The final transport passenger cost declines from around €0.11/p-km in 2015 to over €0.07/p-km by 2050, as shown in Figure 3.2-21. Final transport passenger costs decline for road transport through the transition, whereas for marine and aviation there is a marginal increase. Similarly, final

transport freight costs decline from around €0.065/t-km in 2015 to €0.025/t-km by 2050, as shown in Figure 3.2-21. The final freight costs in the case of road declines through the transition, whereas it increases slightly for aviation and remains stable for rail and marine.

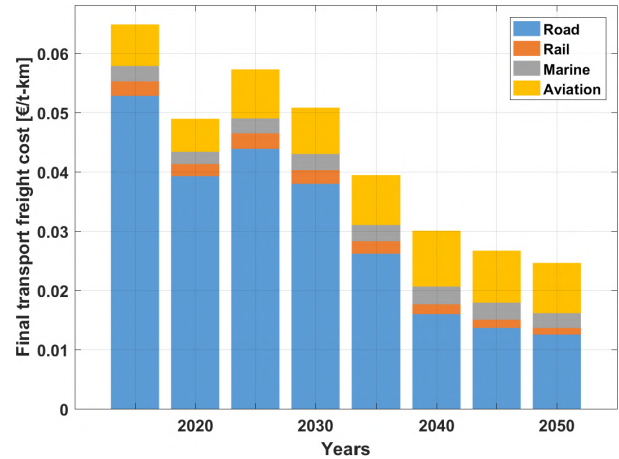
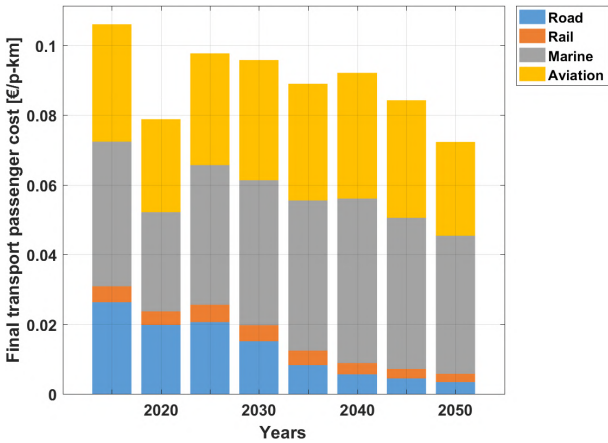

Figure 3.2-21: Europe – Final transport passenger cost (left) and final transport freight cost (right) during the energy transition from 2015 to 2050.

Desalination

The desalination demand in Europe is relatively small compared to other regions of the world. Therefore, the installed capacity of power generation for the desalination sector increases from around 1 GW in 2015 to around 250 GW by 2050 as shown in Figure 3.2-22. Solar PV and wind comprise the majority of installed capacities from 2030 until 2050. Primary electricity generation to meet the desalination demand in the initial period of the transition is from fossil gas up to 2030,

beyond which PV and wind dominate as highlighted in Figure 3.2-22.

The installed storage capacity for desalination occurs mainly from 2035 onwards, with most of the capacity added in the final five-year period until 2050, as shown in Figure 3.2-23. Gas comprises more than 95% of the 23 TWh installed storage capacity in 2050, whereas batteries contribute the majority of the storage output, which reaches more than 110 TWh_{el} by 2050 as shown in Figure 3.2-23.

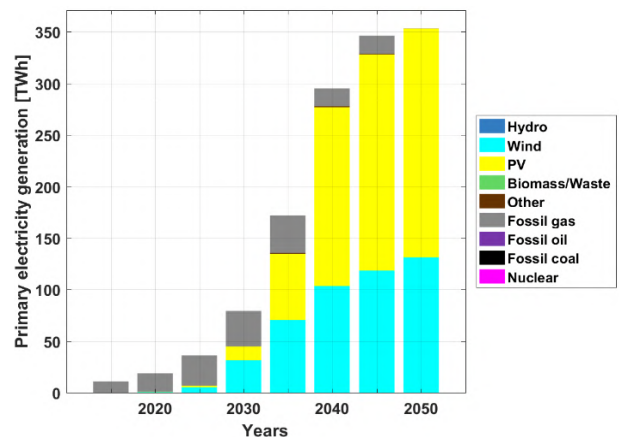
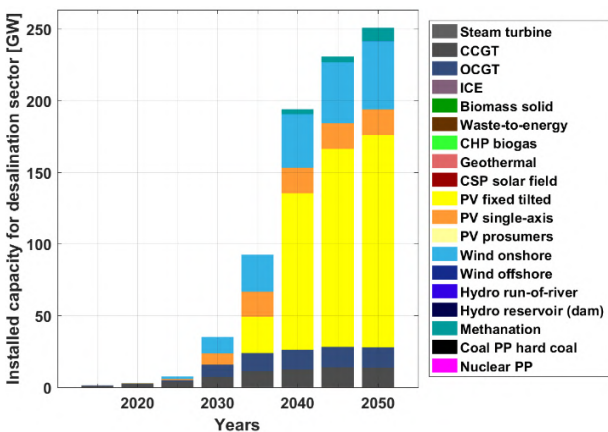

Figure 3.2-22: Europe – Technology-wise installed capacities for the desalination sector (left) and primary electricity generation for the desalination sector (right) during the energy transition from 2015 to 2050.

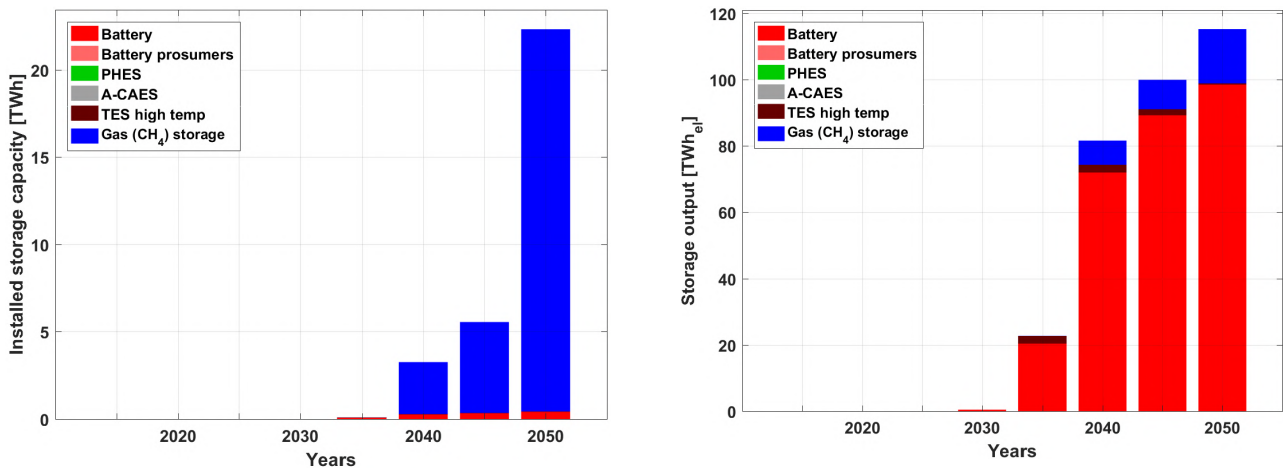

Figure 3.2-23: Europe – Installed storage capacity (left) and storage output (right) during the energy transition from 2015 to 2050.

Investments in power generation for the desalination sector occur mainly during 2025 to 2040, as shown in Figure 3.2-24. A majority of the investment is in wind, PV, and batteries, which

reaches a high of around €60 billion in 2040. The levelised cost of water declines through the transition from around €1.2/m³ in 2015 to around €0.6/m³ by 2050, as shown in Figure 3.2-24.

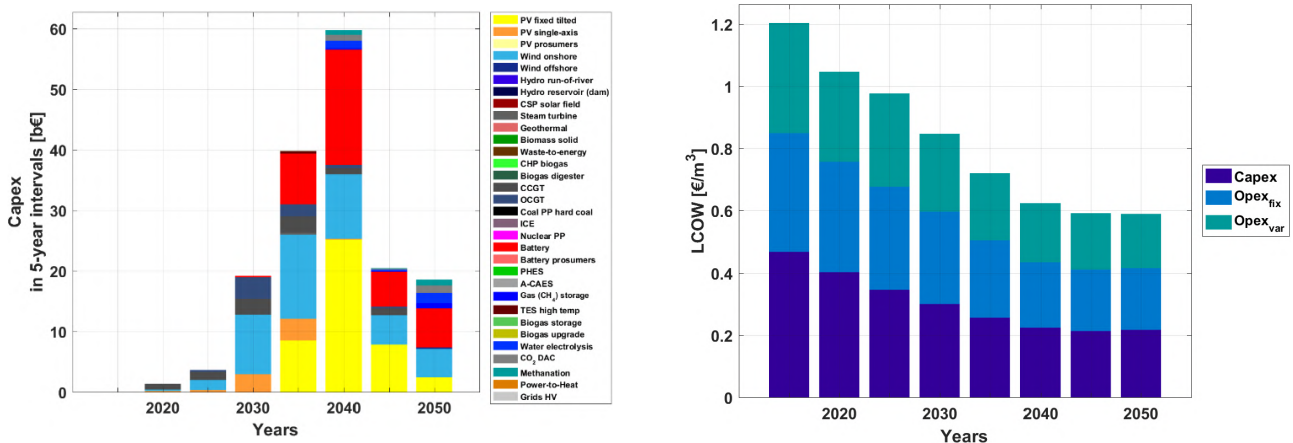

Figure 3.2-24: Europe – Capital costs for five-year intervals (left) and levelised cost of water (right) during the energy transition from 2015 to 2050.

Regional Outlook

Electricity generation capacities are installed across Europe to satisfy the demand for power, heat, transport, and desalination up to 2050. Solar PV capacities are predominantly in the southern regions of Europe that have better solar resources through the year, while wind energy capacities are mainly in the northern regions of Europe that have much better wind conditions, as shown in Figure 3.2-25. Overall, solar PV and wind capacities along

with some hydropower capacities constitute the majority of installed capacity in 2050 across Europe. Similarly, higher shares of solar PV generation are in the southern regions and higher shares of wind energy are in the northern regions as highlighted in Figure 3.2-25. This could enhance the complementarity of solar PV and wind in an interconnected European energy system.

Regional electricity capacities

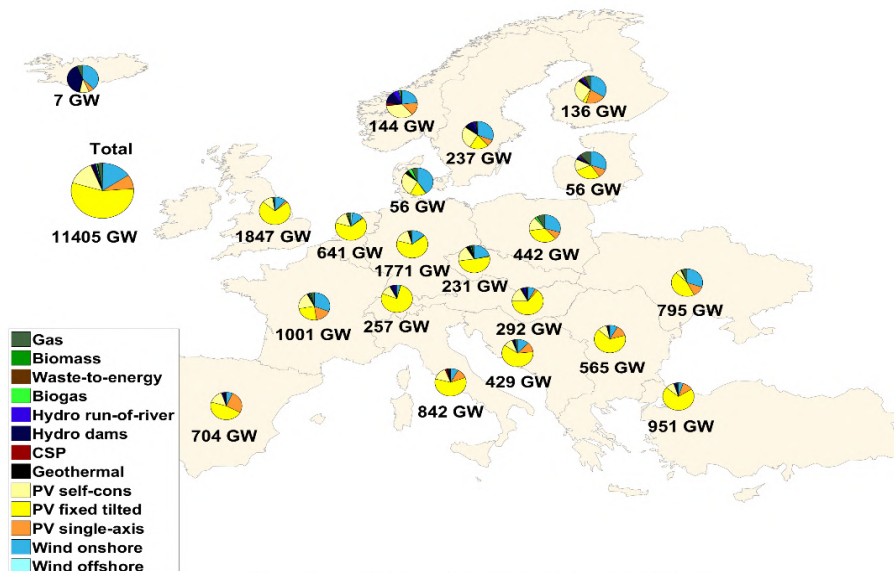

Regional electricity generation

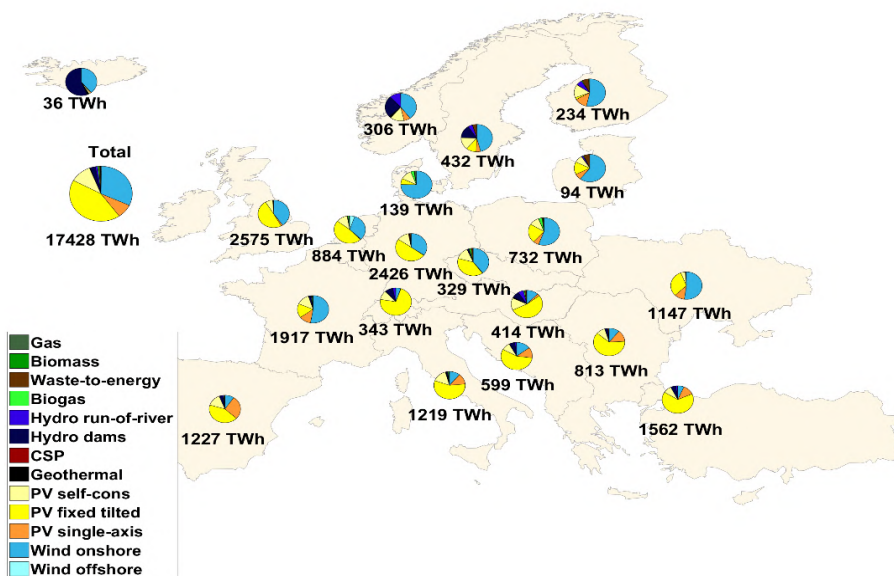

Figure 3.2-25: Europe – Regional electricity generation capacities (top) and electricity generation (bottom) in 2050.

Solar PV capacities are well distributed across the different regions of Europe and achieve a total installed capacity base of almost 8940 GW in 2050. Moreover, there are higher capacities mostly in the southern countries with good solar condition for most parts of the year, as shown in Figure 3.2-26.

Whereas, wind energy capacities achieve a total installed capacity base of almost 1770 GW in 2050 and are predominantly in the northern regions, which show a strong seasonality effect, i.e. parts of northern Europe implying higher wind energy capacities. This can be observed in Figure 3.2-26.

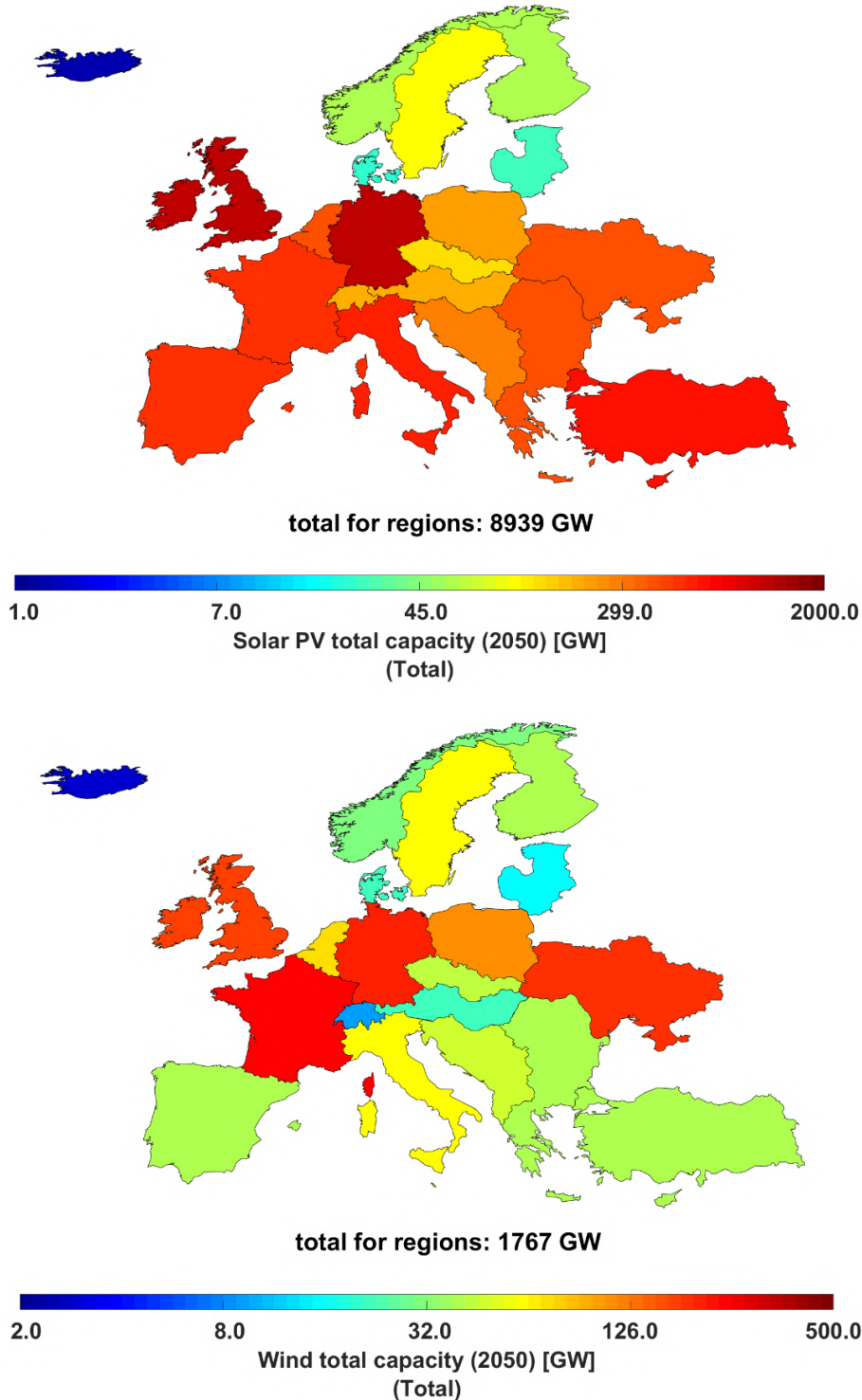

Figure 3.2-26: Europe – Regional variation of electricity generation capacities of solar PV (top) and wind energy (bottom) in 2050.

The electricity generation across the power, heat, transport, and desalination sectors of Europe are predominantly from PV and wind in 2050, as shown in Figure 3.2-27. Solar PV, which supplies an average of 62.2% of electricity generation across Europe, is more common in the southern regions of

Europe. While wind energy, which contributes an average of 32% of electricity generation across Europe is mainly, found in the northern regions. Overall, solar PV and wind generate most of the electricity needed across Europe by 2050, which is around 94.2% of total electricity generation.

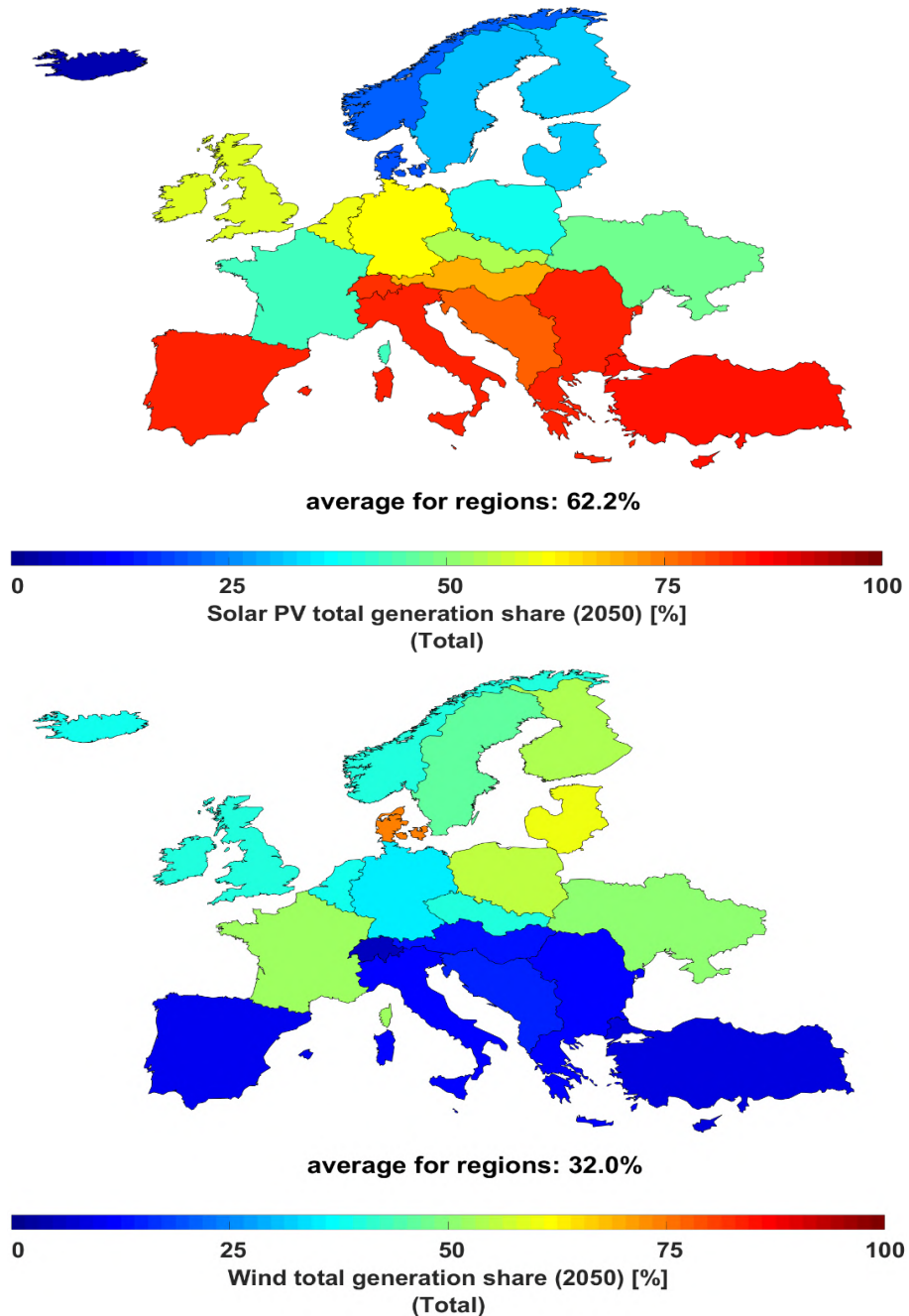
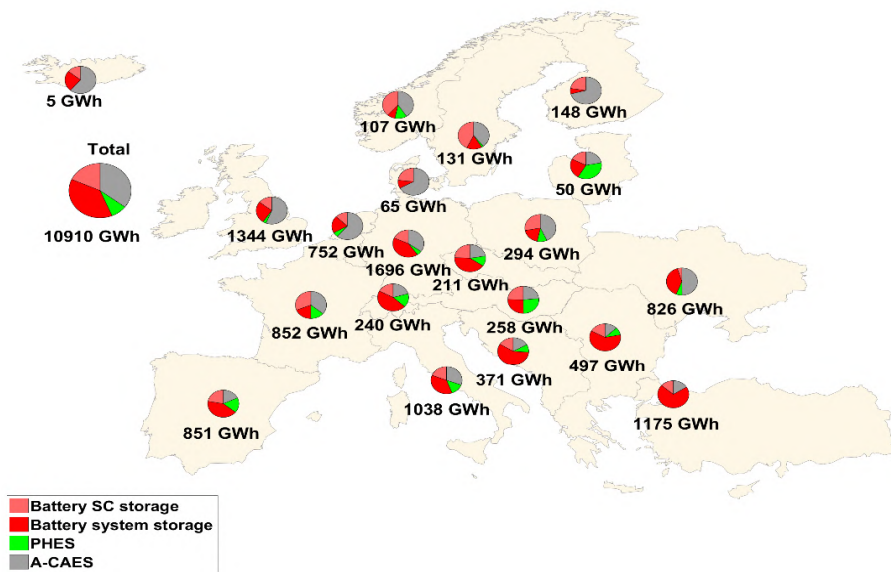

Figure 3.2-27: Europe – Regional variation of electricity generation shares of solar PV (top) and wind energy (bottom) in 2050.

Utility-scale and prosumer batteries contribute a major share of electricity storage capacities, with some shares of PHEs and A-CAES by 2050, as shown in Figure 3.2-28. Storage capacities are much higher in the southern parts of Europe, to complement higher shares of installed solar PV capacities, compared to the northern regions.

Batteries, both prosumers and utility-scale, deliver the largest shares of output by 2050, as shown in Figure 3.2-28. PHEs and A-CAES contribute complementary shares of electricity storage output through the transition, across the different regions of Europe.

Regional electricity storage capacities



Regional electricity storage annual generation

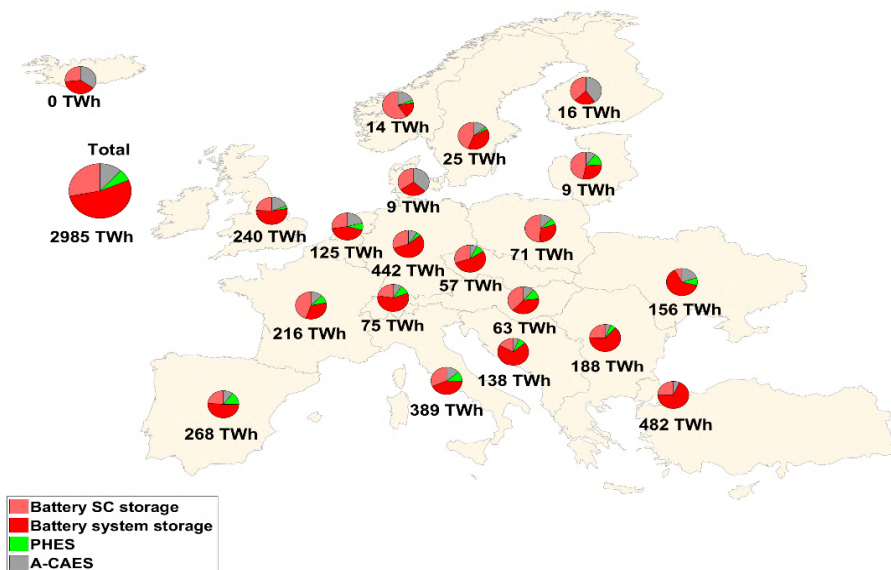

Figure 3.2-28: Europe – Regional electricity storage capacities (top) and electricity storage annual throughput (bottom) in 2050.

The storage output across the power, heat, transport, and desalination sectors of Europe is predominantly from batteries (both utility-scale and prosumers) and some synthetic natural gas supply in 2050, as shown in Figure 3.2-29. Batteries, which supply an average of 15.6% of the storage output across Europe, are more common in the southern

regions of Europe. Synthetic natural gas, which supplies an average of 0.3% of the total electricity demand across Europe, is predominant in the eastern regions of Europe. This is complemented with a supply share of storage from biomethane of around 0.4% in 2050 across Europe.

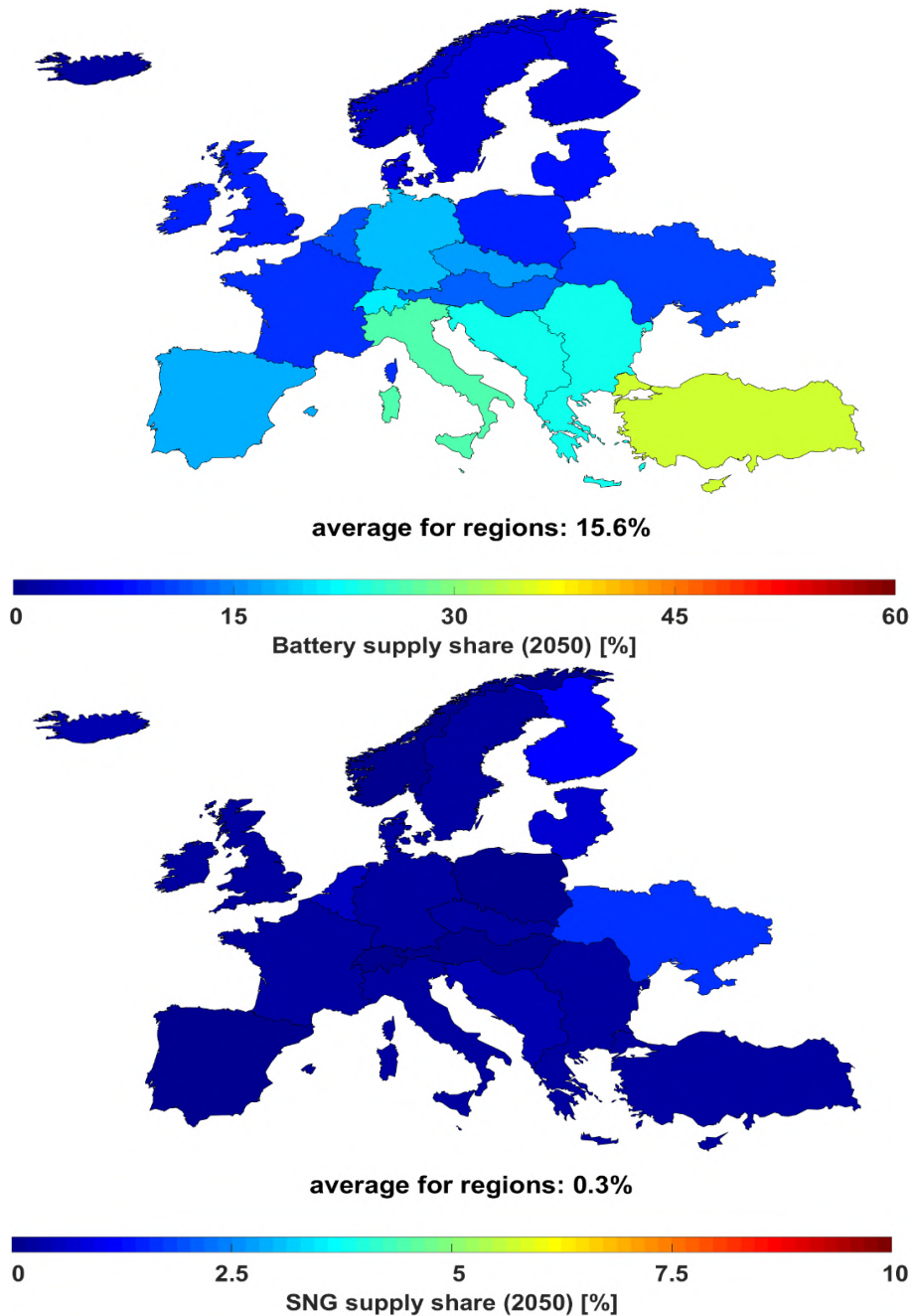

Figure 3.2-29: Europe – Regional variation of storage supply shares of batteries (top) and synthetic natural gas (bottom) in 2050.

Greenhouse Gas Emissions

The results of the global transition towards a 100% renewable energy system indicate a sharp decline in GHG emissions until 2050, reaching zero GHG emissions by 2050 across the power, heat, transport, and desalination sectors in Europe as shown in Figure 3.2-30. The power sector undergoes a deep decarbonisation by 2030, whereas for the heat and transport sectors this occurs mostly between 2030 and 2050. Moreover, the remaining cumulative GHG emissions comprise

around 65 GtCO_{2eq} from 2018 to 2050. Therefore, the energy transition pathway for Europe is in adherence to the ambitious Paris Agreement target of 1.5°C.

GHG emissions from the power sector decline through the transition from around 1,100 MtCO₂ eq./a in 2015 to zero by 2050 as shown in Figure 3.2-31. Similarly, GHG emissions from the heat sector decline through the transition from over 1200 MtCO₂ eq./a in 2015 to zero by 2050 as shown in Figure 3.2-31.

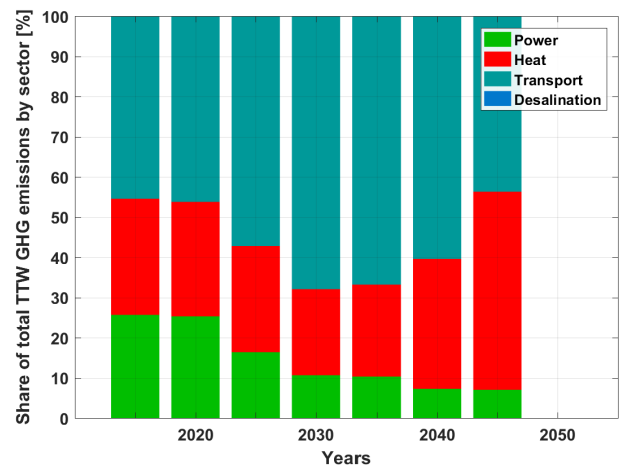
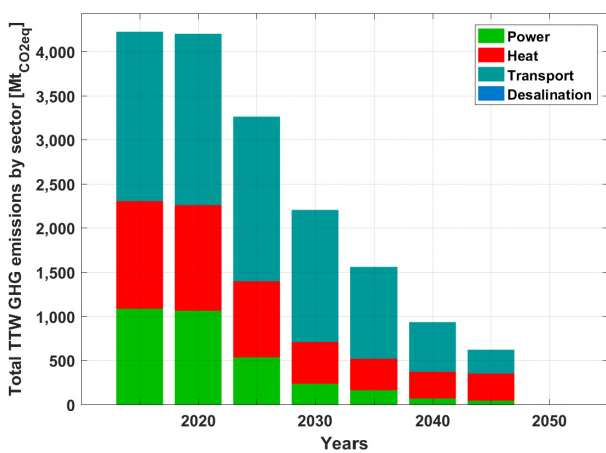

Figure 3.2-30: Europe – Sector-wise GHG emissions (left) and the share of GHG emissions of different sectors (right) during the energy transition from 2015 to 2050. Tank to Wheel (TtW) considers GHG emissions from readily available fuels and does not consider GHG emissions from the upstream production and delivery of fuels.

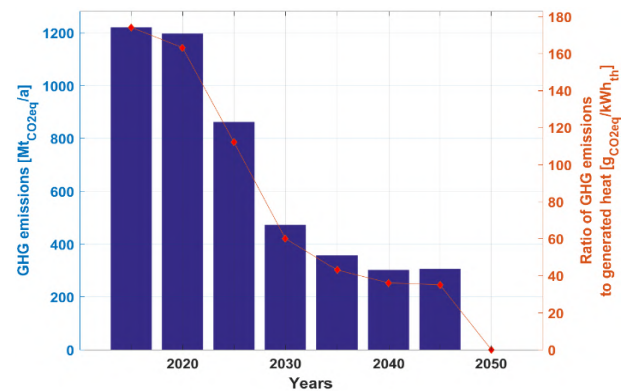
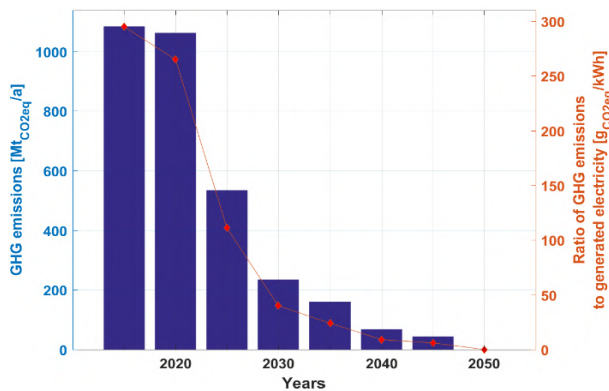

Figure 3.2-31: Europe – GHG emissions in the power sector (left) and GHG emissions in the heat sector (right) during the energy transition from 2015 to 2050.

GHG emissions from the transport sector decline through the transition from around 1,900 MtCO₂ eq./a in 2015 to zero by 2050, as shown in Figure 3.2-32. Similarly, GHG emissions from the

desalination sector, which are much lower than those of the other sectors, decline through the transition from around 4.5 MtCO₂ eq./a in 2015 to zero by 2050, also visible in Figure 3.2-32.

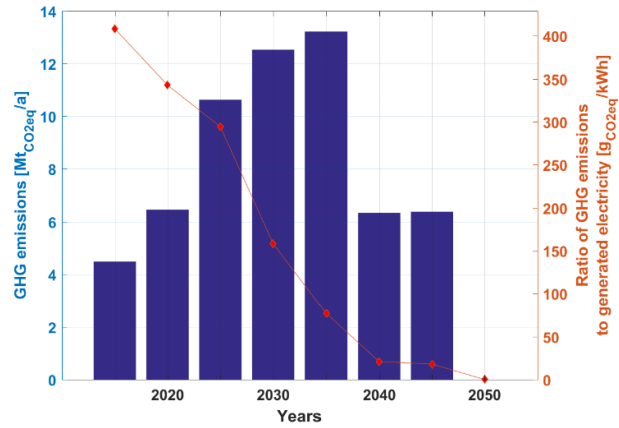
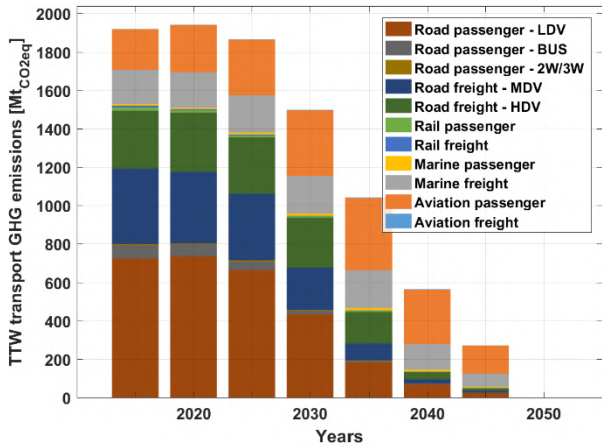

Figure 3.2-32: Europe – GHG emissions in the transport sector (left) and GHG emissions in the desalination sector (right) during the energy transition from 2015 to 2050. Tank to Wheel (TTW) considers GHG emissions from readily available fuels and does not consider GHG emissions from the upstream production and delivery of fuels.

Jobs in the European Power Sector

There were just over 2 million direct jobs in the energy sector across Europe in 2015, with more than 50% of these in the renewable energy sector. With the rapid increase in renewable energy installations up to 2025, jobs in the energy sector are seen to rise to around 3.7 million, and stabilise between 3.3 million by 2035 and 3.4 million by 2050 as shown in Figure 3.2-33. Solar PV emerges

as the major job creating sector with 1.73 million jobs by 2050. Storage technologies led by batteries are observed to start creating jobs from 2025 onwards, with a stable share until 2050 with 277,000 jobs in the battery sector. Conversely, jobs in the fossil fuel and nuclear sectors decline through the transition period and by 2050 are almost non-existent apart from a few thousand jobs associated with the decommissioning of conventional power plants.

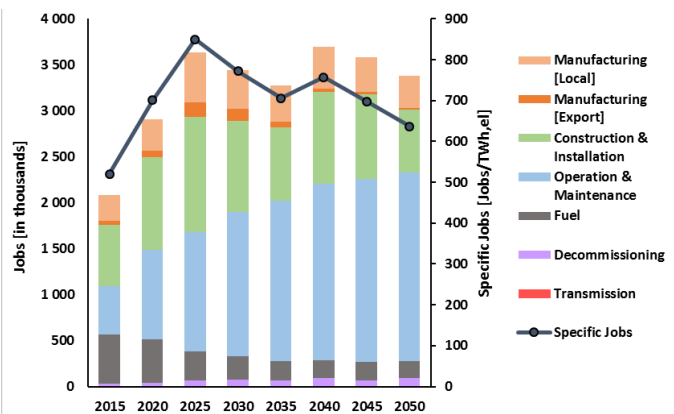
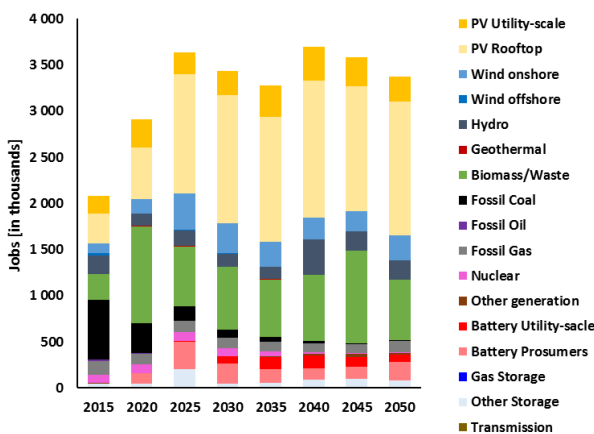

Figure 3.2-33: Europe – Jobs created by various power generation and storage technologies (left) and jobs created based on different categories with the development of electricity demand specific jobs (right) during the energy transition from 2015 to 2050.

Manufacturing, construction, and installation of renewable energy technologies create a significant share of jobs enabling the rapid ramp-up of capacity until 2025. Beyond this period, a stable number of jobs will be created in these sectors up to 2050 with over a million jobs. Furthermore, manufacturing includes goods both for local use as well as for exporting to other regions. The share of exports initially increases up until 2030 with over 4% of total jobs, beyond which it declines and manufacturing predominantly caters to the local power market across Europe. Fuel jobs continue to decline through the transition period reaching just 6% of total jobs by 2050, as capacities of conventional power plants continue to decline. In

contrast, operations and maintenance jobs continue to grow through the transition period and become the major job segment by 2050 with 61% of total jobs. As operations and maintenance jobs last through the lifetime of power plants, they offer relatively stable long-term job prospects. The electricity demand specific jobs indicates the total number of jobs created annually for every TWh_{el} of annual electricity generation during the energy transition. As indicated in Figure 3.2-33, the specific jobs were at 516 jobs/TWh_{el} in 2015, increasing to 859 jobs/TWh_{el} in 2025 with the rapid ramp-up in renewable energy installations. Beyond 2025, it declines steadily to 638 jobs/TWh_{el} by 2050.

3.3. Eurasia

Countries in Eurasia are amongst the emerging economies of the world, with around a 6% share of global GDP ⁶³ and an increasing appetite for energy. Population in Eurasia is 233 million in 2015 representing a share of 3% in world population, which is estimated to be 2% in 2050. The region predominantly being a hub for fossil fuel production has abundant renewable energy resources. Additionally, Eurasia has an ageing power sector with the majority of its power plant infrastructure built prior to 1990's. This provides an opportunity for the region to leapfrog into the energy transition by switching to renewable power plant installations of the future ⁵⁰. The results

indicate an incremental shift towards a 100% renewable energy system for Eurasia across the power, heat, transport and desalination sectors. The detailed results for the energy transition across Eurasia are available in a supplementary data file, the link for the file can be found in the Appendix.

Penetration of renewables is not just a matter of replacing hydrocarbons with zero-carbon sources of energy supply – it also represents a significant change in resource efficiency. This is illustrated by the overall electrification across the power, heat, transport, and desalination sectors as shown in Figure 3.3-1.

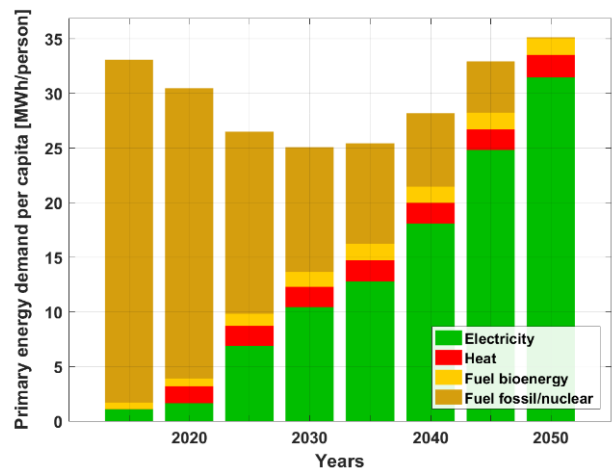
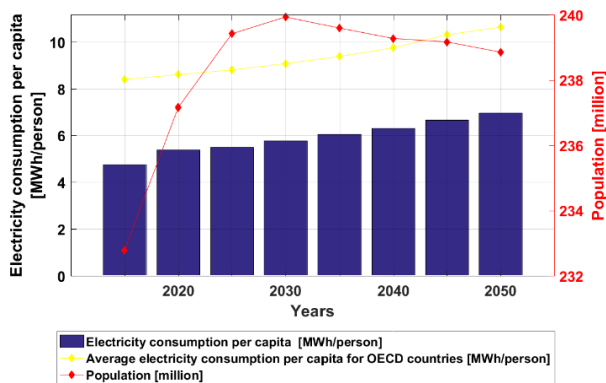
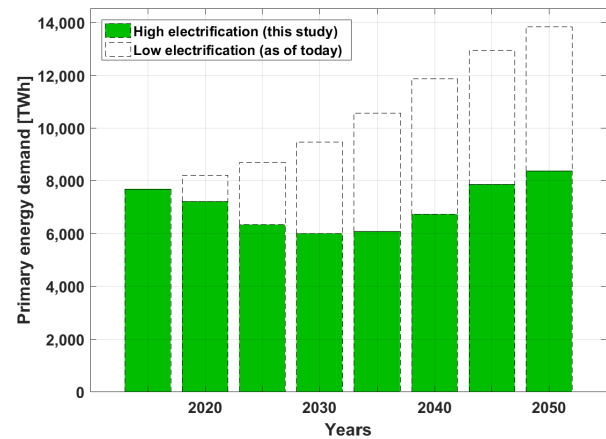
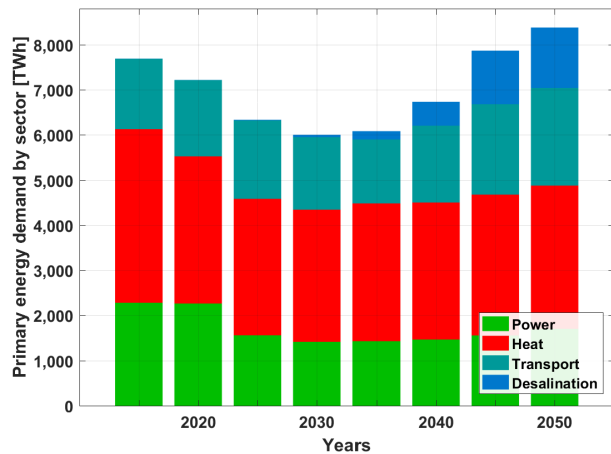

Figure 3.3-1: Eurasia – Primary energy demand sector-wise (top left), efficiency gain in primary energy demand (top right), electricity consumption per capita with population (bottom left) and primary energy demand per capita (bottom right) during the energy transition from 2015 to 2050 in Europe.

A regional cumulative average annual growth rate of about 1.6% in final energy demand drives the transition. This is aggregated by final energy demand growth for power and heat, desalinated water demand and transportation demand linked to powertrain assumptions. This leads to comprehensive electrification across the different energy sectors, which massively increases overall energy efficiency to an even higher growth rate in provided energy services. This results in an average annual growth rate of about 0.3% in total primary energy demand (TPED).

The population across Eurasia is expected to grow slightly from 233 to 239 million people by 2050. The primary energy demand assuming high electrification, which is the basis for this study, decreases from 7,600 TWh in 2015 to around 6,000 TWh by 2035 and increases up to 8,200 TWh by 2050. On the contrary, with low shares of electrification resulting from the adoption of current practices until 2050, the primary energy demand would reach nearly 14,000 TWh by 2050. The average per capita energy demand decreases from around 33 MWh/person in 2015 to 25 MWh/person by 2035 and increases up to nearly 35 MWh/person by 2050. The massive gain in energy

efficiency is primarily due to a high level of electrification of more than 88%, resulting in energy reduction of around 5,800 TWh by 2050 in comparison to the continuation of current practices with low shares of electrification. Additionally, a substantial demand from desalination arises beyond 2035 across Eurasia leading to a higher energy demand (see Figure 3.3-1).

Energy Supply

The electricity generation capacity across Eurasia satisfies demand from all energy sectors including power, heat, transport and desalination. The total installed capacity grows massively from over 300 GW in 2015 to around 4500 GW by 2050 as shown in Figure 3.3-2. In the initial period of the transition, a larger share of wind capacities are installed up to 2040 and reach around 1170 GW by 2050, but in the later part of the transition solar PV dominates the shares of installed capacities reaching around 2600 GW by 2050. On the other hand, the shares of fossil fuels and nuclear decline through the transition to zero by 2050. Some shares of gas remain, but the fuel switches from fossil-based gas to synthetic natural gas produced with renewable electricity and biomethane.

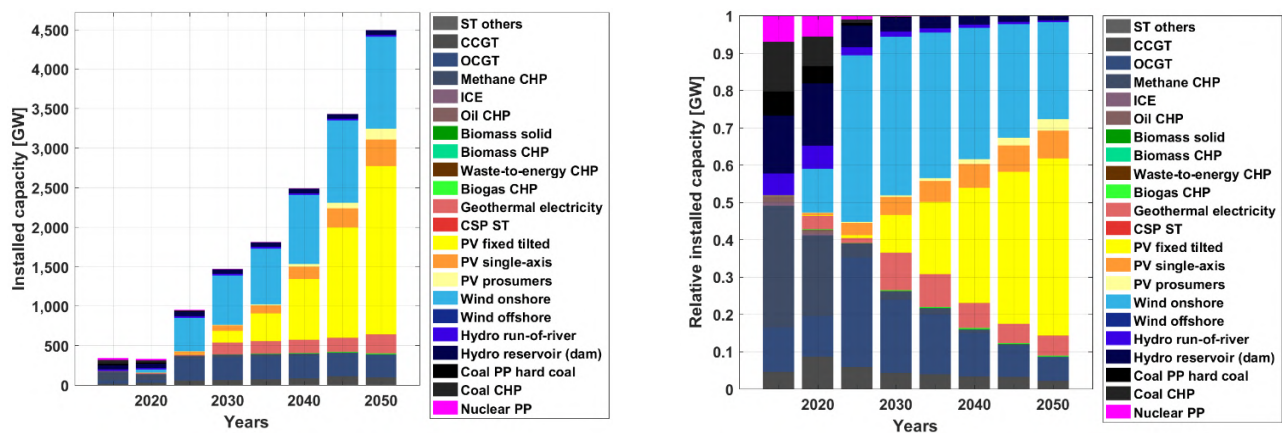

Figure 3.3-2: Eurasia – Technology-wise installed capacities (left) and technology-wise shares of installed capacities (right) during the energy transition from 2015 to 2050.

Electricity generation from the various technologies to cover the demand of power, heat, transport, and desalination sectors is shown in Figure 3.3-3. As there are excellent wind conditions prevalent across Eurasia, wind energy increases to around 69% by 2030 and contributes a stable share of the energy mix with up to 47% by 2050. Solar PV

supply increases substantially in the later part of the transition to around 42% by 2050, with better cost competitiveness. In the heat sector, heat pumps play a significant role through the transition with a share of more than 61% of heat generation by 2050 supplied on both, the district and individual levels, as indicated in Figure 3.3-3.

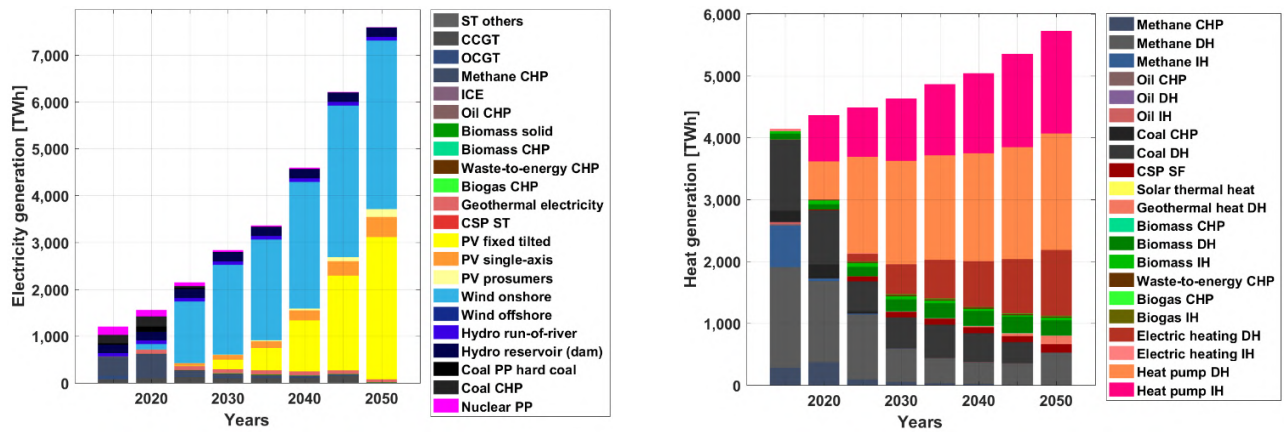

Figure 3.3-3: Eurasia – Technology-wise electricity generation (left) and technology-wise heat generation (right) during the energy transition from 2015 to 2050.

Electric heating along with some shares of non-fossil gas and biomass based heating contributes through the transition towards covering the heating demand. On the other hand, gas-based heating decreases through the transition from over 56% in 2015, to around 9% by 2050. Additionally, fossil fuel-based heating decreases due to the replacement of coal-based CHP and DH by waste-to-energy CHP, biomass-based DH and IH.

Energy Storage

Energy storage technologies play a critical role in enabling a secure energy supply throughout Eurasia, fully based on renewable energy across different sectors. As highlighted in Figure 3.3-4,

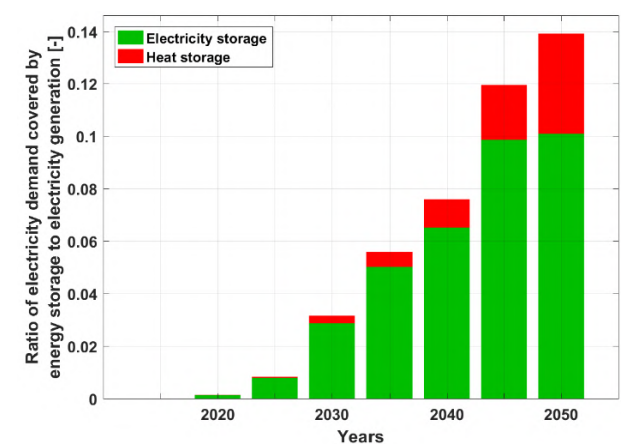
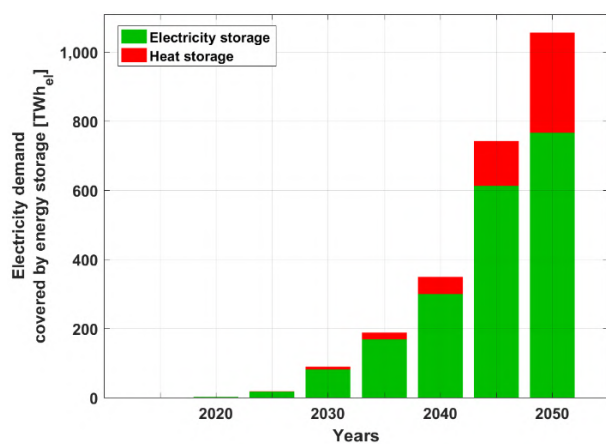

Figure 3.3-4: Eurasia – Electricity demand covered by energy storage (left) and ratio of electricity demand covered by different forms of energy storage (right) during the energy transition from 2015 to 2050.

Similarly, heat storage plays a vital role in ensuring that heat demand is covered across all the sectors. As indicated in Figure 3.3-5, storage output covers more than 1300 TWh_{th} of heat demand in 2050 and heat storage technologies are crucial to meet this

demand. The ratio of heat demand covered by energy storage to total heat generation increases substantially to almost 20% by 2050, also shown in Figure 3.3-5.

Close to 3% of this is provided by electricity to heat storage technologies. Thermal energy storage (TES) emerges as the most relevant heat storage technology with around 40-60% of heat storage output from 2030 until 2050. Furthermore, power-

to-gas (PtG) contributes around 51% of heat storage output in 2050. As fossil fuel usage for heat generation is completely eliminated in the final five-year period from 2045-2050, there is a substantial increase in heat storage utilisation.

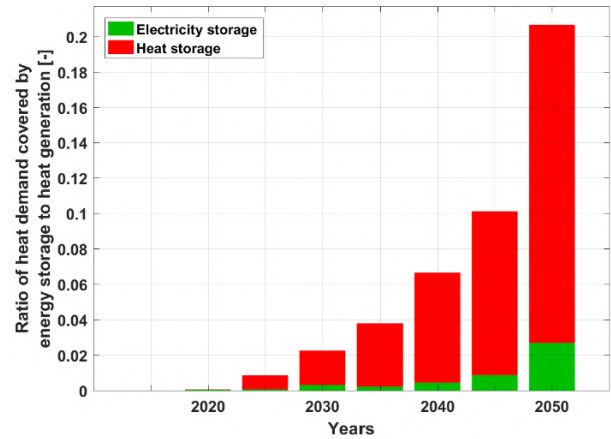
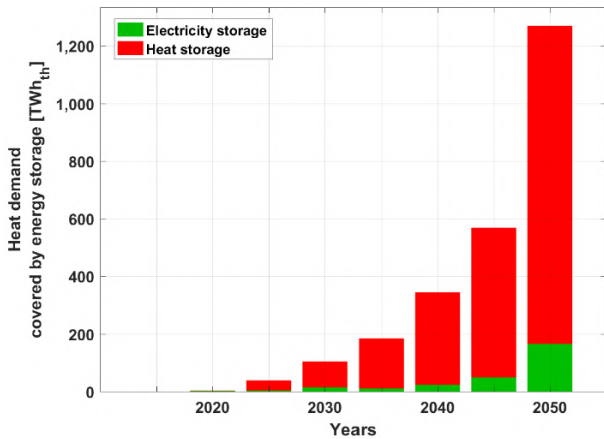

Figure 3.3-5: Eurasia – Heat demand covered by energy storage (left) and the ratio of heat demand covered by different forms of energy storage (right) during the energy transition from 2015 to 2050.

Costs and Investments

The total annual system costs are in the range of 300-450 b€, increasing through the transition period and are well distributed across the major sectors of power, heat, transport and desalination. Desalination investments are predominantly from 2040 onwards. As indicated by Figure 3.3-6, power, heat, and transport costs are in the range of around 300-400 b€ through the transition. In addition as

indicated in Figure 3.3-6, CAPEX increases through the transition, as fuel costs decline. The steady increase in CAPEX-related energy system costs indicate that investments shift from fuels based energy sectors towards power infrastructure based energy sectors across Eurasia. In addition, a lower reliance on fossil fuels will lead to a higher level of energy diversification across Eurasia.

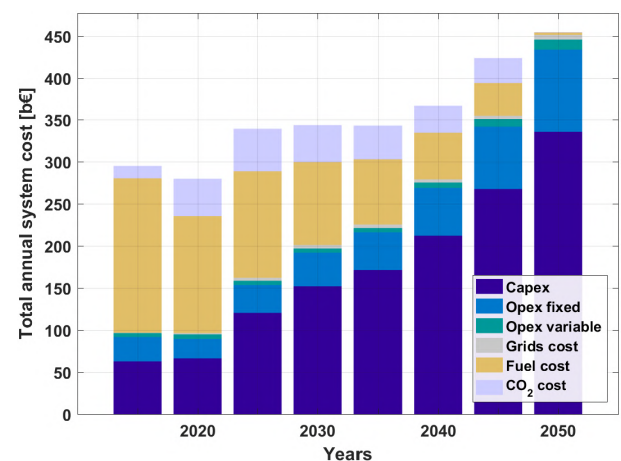
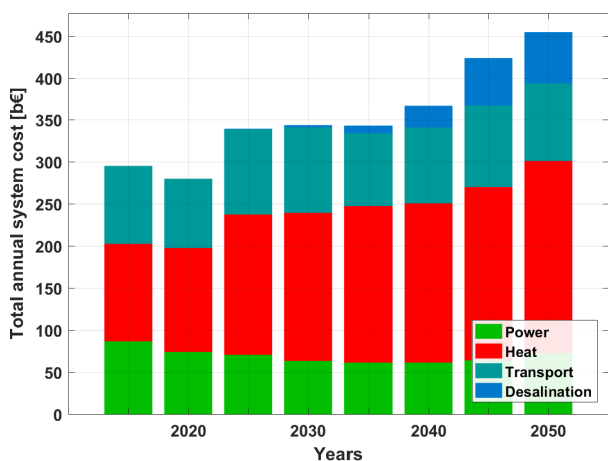

Figure 3.3-6: Eurasia – Annual system costs, sector-wise (left) and functionality-wise (right) during the energy transition from 2015 to 2050.

As increasing shares of power generation capacities are added globally, renewable energy sources become the least cost power generation source ⁶⁶. As indicated in Figure 3.3-7, levelised cost of energy remains around 43-53 €/MWh and is increasingly dominated by capital costs as fuel costs continue to decline through the transition period, which enables increased diversification in

terms of energy for Eurasia by 2050 as mentioned earlier. Capital costs are well spread across a range of technologies with major investments in wind energy, solar PV, batteries, heat pumps, and synthetic fuel conversion technologies up to 2050, as shown in Figure 3.3-7. The cumulative investments are about 4,240 b€ through the transition from 2016-2050.

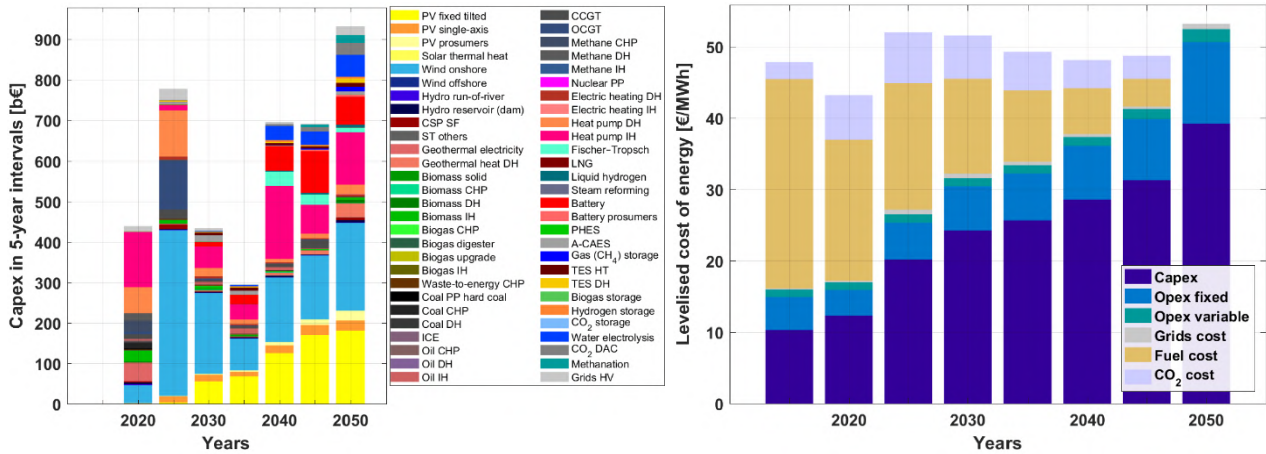

Figure 3.3-7: Eurasia – Capital costs for five-year intervals (left) and levelised cost of energy (right) during the energy transition from 2015 to 2050.

Outlook across Sectors

Different trends in the power, heat, transport, and desalination sectors across Eurasia emerge through the transition. As the sectors transition towards higher shares of renewable energy, different technologies have vital roles in ensuring the stability of the energy system. A closer look at the individual sectors provides further insights into the energy transition across Eurasia towards 100% renewable energy.

Power and Heat

The total installed power generation capacity increases from nearly 300 GW in 2015 to around 2,600 GW by 2050, as shown in Figure 3.3-8. Across the power sector, solar PV with around 1.260 GW and wind with around 650 GW constitute the majority of installed capacities by 2050. Additionally, some shares of hydropower, geothermal and non-fossil gas based electricity contribute through the transition. In the heat sector, heat pumps, electric heating and biomass-based heating constitute the majority of installed capacities by 2050, also shown in Figure 3.3-8. A significant increase in installed capacities of heat pumps and biomass-based heating occurs in the final five-year period leading up to 2050, as fossil fuels are completely eliminated from the energy system.

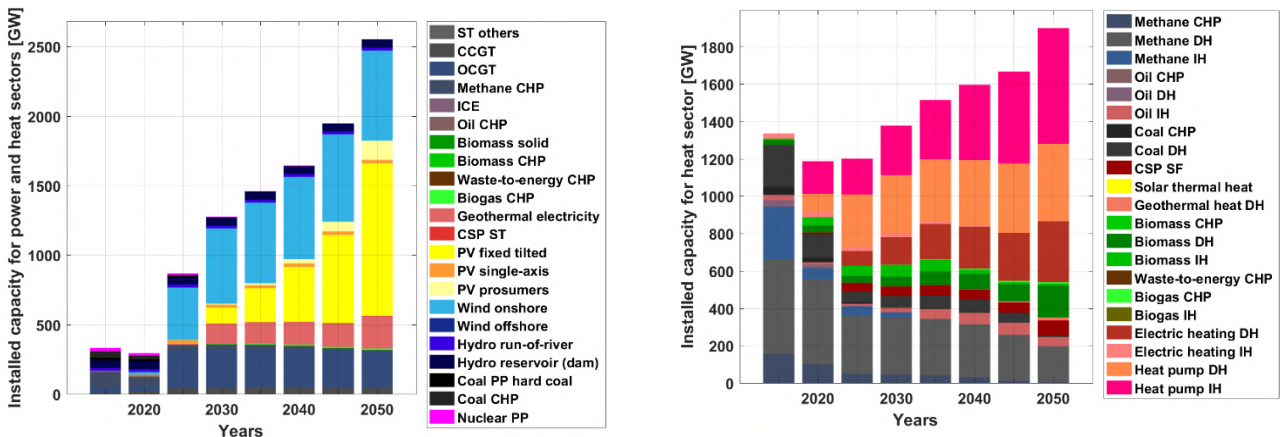

Figure 3.3-8: Technology-wise installed capacities for power (left) and heat (right) during the energy transition from 2015 to 2050 in Europe.

The transition across Eurasia results in a power and heat sector dominated by fossil fuels and nuclear in 2015, moving towards a wind and solar PV dominated sector by 2050, with some hydropower, geothermal and bioenergy as shown in Figure 3.3-9. The primary electricity generation increases from around 1,150 TWh in 2015 to over 4,000 TWh by

2050, which is primarily from wind energy and solar PV. Heat generation increases from over 4,000 TWh in 2015 to around 5,600 TWh by 2050, which is mainly from heat pumps and electric heating with some non-fossil gas and biomass-based heating, also shown in Figure 3.3-9.

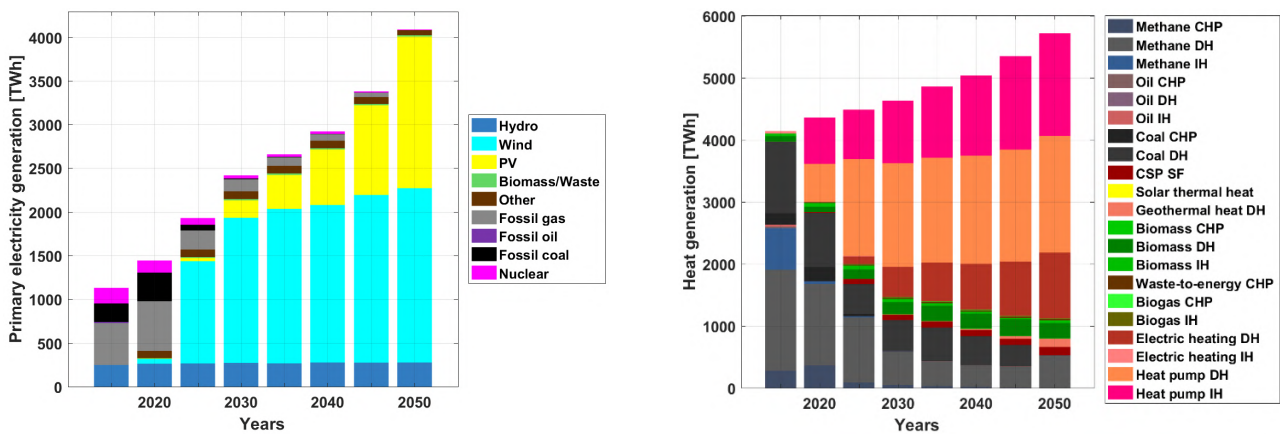

Figure 3.3-9: Eurasia – Primary electricity generation (left) and technology-wise heat generation (right) during the energy transition from 2015 to 2050.

The installed electricity storage capacity increases from just 0.1 TWh in 2015 to around 1.2 TWh by 2050, as shown in Figure 3.3-10. Utility-scale and prosumer batteries with some shares of PHES and A-CAES are installed through the transition. The installed capacities of A-CAES are also a consequence of the modelling approach, which prioritises full domestic energy supply for all

regions across Eurasia. The installed heat storage increases mainly from 2040 onwards to around 130 TWh by 2050, but in the final five-year period up to 2050, a massive capacity of gas storage of nearly 125 TWh is added, as shown in Figure 3.3-10. This substantial capacity addition is mainly to provide seasonal storage across Eurasia covering the heat demand in the absence of fossil fuels.

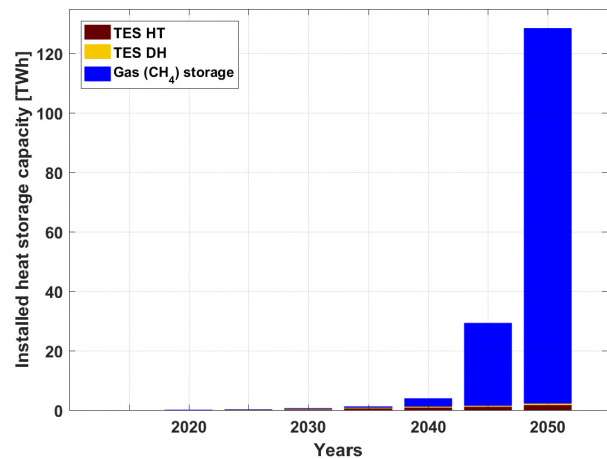
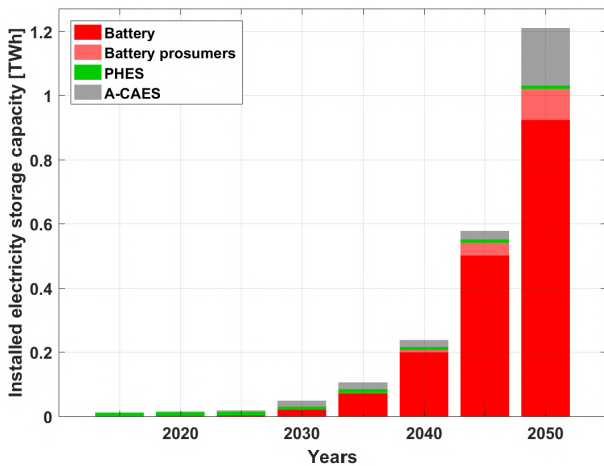

Figure 3.3-10: Eurasia – Installed electricity storage capacities (left) and heat storage capacities (right) during the energy transition from 2015 to 2050.

Utility-scale and prosumer batteries contribute a major share of electricity storage output with nearly 94% by 2050, as highlighted by Figure 3.3-11. In addition, PHEs and A-CAES contribute through the transition. TES emerges as the most relevant heat

storage technology with over 50% of heat storage output by 2050, also seen in Figure 3.3-11. Gas storage contributes around 49% of the heat storage output in 2050 covering majorly the seasonal demand, previously covered by fossil gas.

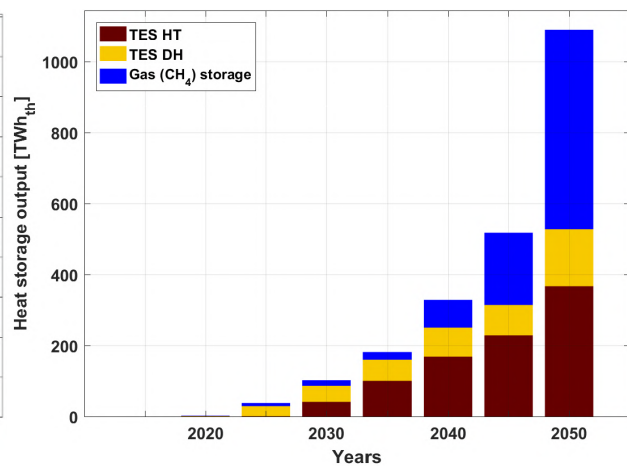
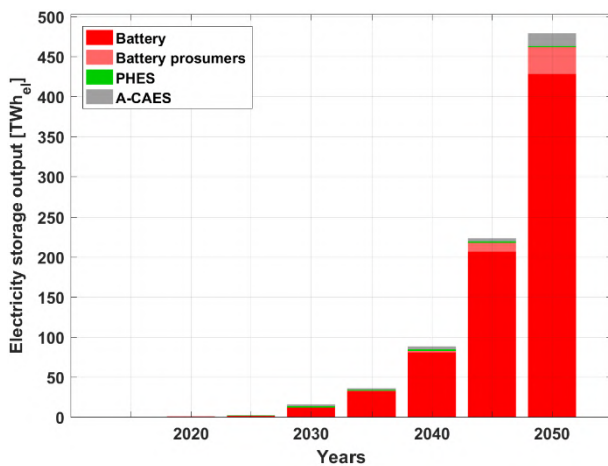

Figure 3.3-11: Electricity storage output (left) and heat storage output (right) during the energy transition from 2015 to 2050 in Europe.

LCOE of the power sector decreases substantially from around 83 €/MWh in 2015 to around 58 €/MWh by 2050, as shown in Figure 3.3-12. LCOE is predominantly comprised of CAPEX as fuel costs decline through the transition. The LCOH of the heat sector increases from around 32 €/MWh in 2015 to around 47 €/MWh by 2050, as shown in

Figure 3.3-12. LCOH is mainly comprised of CAPEX as fuel costs decline through the transition. Despite a substantial increase in heat demand across Eurasia, mainly driven by industrial process heat and increased space heating, the LCOH remains quite stable through the transition.

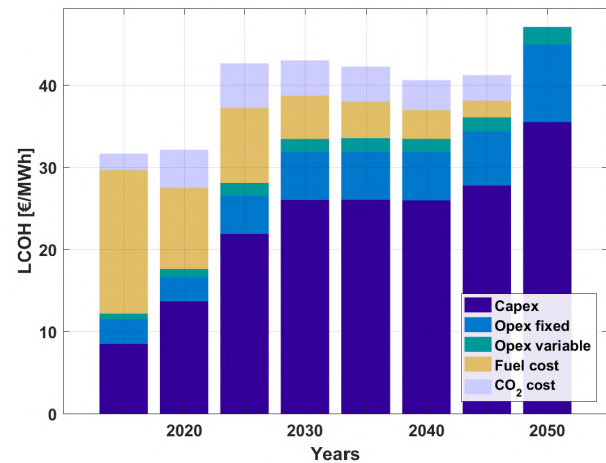
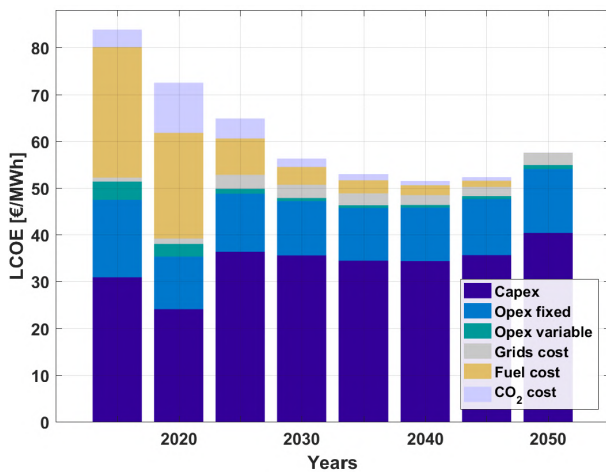

Figure 3.3-12: Levelised cost of electricity (left) and levelised cost of heat (right) during the energy transition from 2015 to 2050 in Europe.

Investments are well spread across a range of power generation technologies with the majority share in wind energy up to 2030, beyond which solar PV dominates investments up to 2050, as shown in Figure 3.3-13. Investments in the heat sector are mainly in heat pumps and some shares in biomass heating up to 2050, also shown in Figure

3.3-13. The steep increase in heat pump investments in the five-year periods of 2040 and 2050 is mainly to cover the heat demand in the absence of fossil fuels, as well as driven by the lower costs of heat pumps in the latter part of the transition.

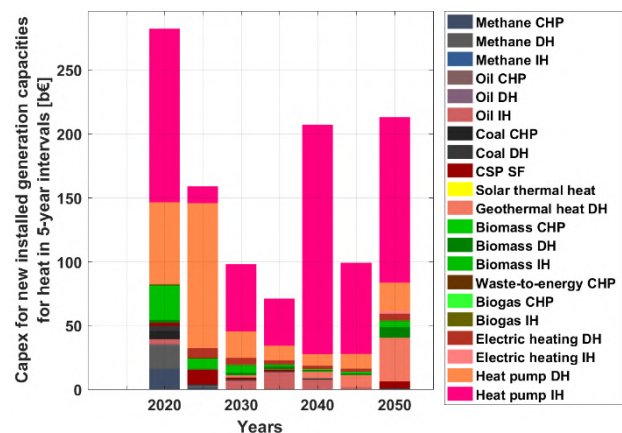
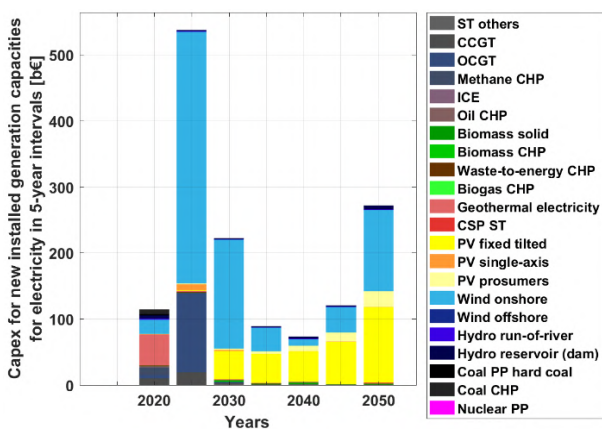

Figure 3.3-13: Eurasia – Capital costs of installed generation capacities in five-year intervals for electricity (left) and heat (right) during the energy transition from 2015 to 2050.

Transport

The primary energy demand of the transport sector across Eurasia is around 1,500 TWh in 2015. However, this demand after increasing in the initial period declines through the transition to around 1,350 TWh, mainly due to the efficiency gains brought about by increasing levels of electrification across the transport sector, as shown in Figure 3.3-14. Fossil fuel consumption in the transport sector across Eurasia is seen to decline through the transition from about 97% in 2015 to zero by 2050. On the other hand, liquid fuels produced by

renewable electricity contribute around 30% of final energy demand in 2050. In addition, hydrogen constitutes more than 23% of final energy demand in 2050. Sustainably produced biofuels contribute a minor share to enable a complete elimination of fossil fuel usage in the transport sector. Electrification of the transport sector creates an electricity demand of around 2,100 TWh_{el} by 2050. The massive demand for liquid fuels kicks in from 2040 onwards up until 2050, as indicated in Figure 3.3-14.

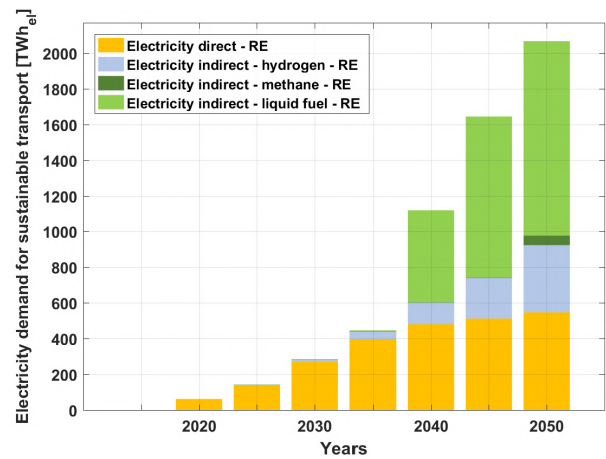
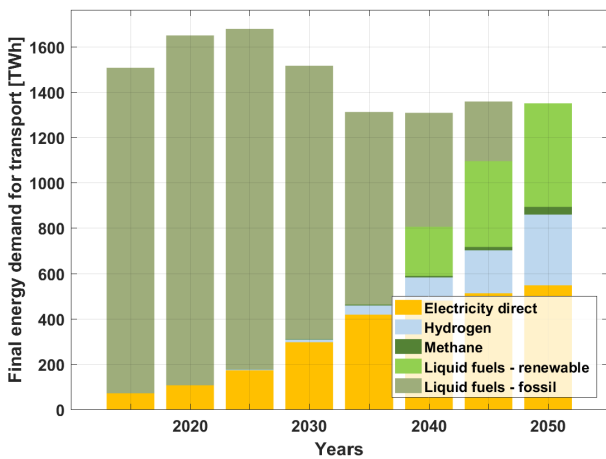

Figure 3.3-14: Eurasia – Final energy demand for transport (left) and electricity demand for sustainable transport (right) during the energy transition from 2015 to 2050.

Installed power generation capacity for the transport sector increases substantially through the transition to over 1,100 GW by 2050, as shown in Figure 3.3-15. Solar PV and wind form the majority share of the power generation capacity for the transport sector, as they are the lowest cost energy

sources by 2050. Similarly, electricity generation increases substantially up to almost 2,300 TWh by 2050 seen in Figure 3.3-15. Wind energy and solar PV generate all the electricity required to meet the demand of the transport sector in 2050.

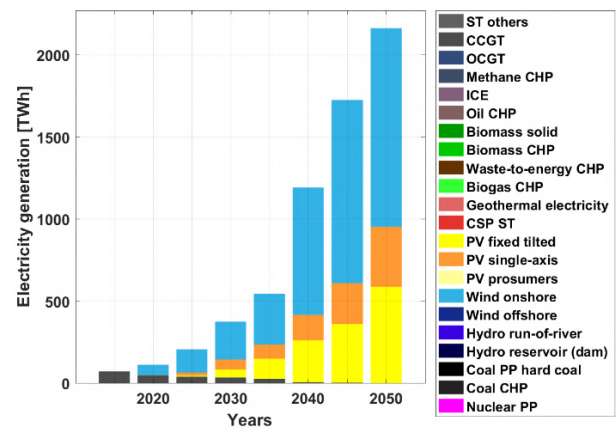
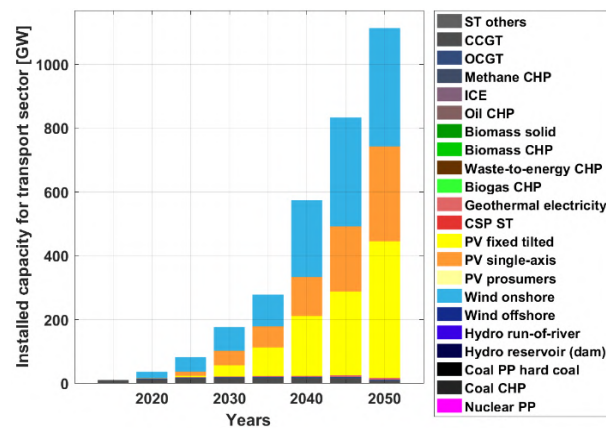

Figure 3.3-15: Eurasia – Transport sector installed power generation capacity (left) and electricity generation (right) during the energy transition from 2015 to 2050.

A critical aspect to complement the electrification of the transport sector is the installation of storage technologies. As seen in Figure 3.3-16, the installed capacities of electricity storage increase through the transition to around 0.8 TWh by 2050. The majority of installed capacities are A-CAES and utility-scale batteries. Similarly, electricity storage output increases through the transition to around 165 TWh_{el} by 2050 as shown in Figure 3.3-16.

Utility-scale batteries play a vital role as they contribute a major portion of the output through the transition, with about 125 TWh_{el} by 2050. The relatively low electricity storage of less than 10% of generated electricity for the transport sector is enabled by the flexible operation of batteries, water electrolyser units, and hydrogen buffer storage for synthetic fuel production.

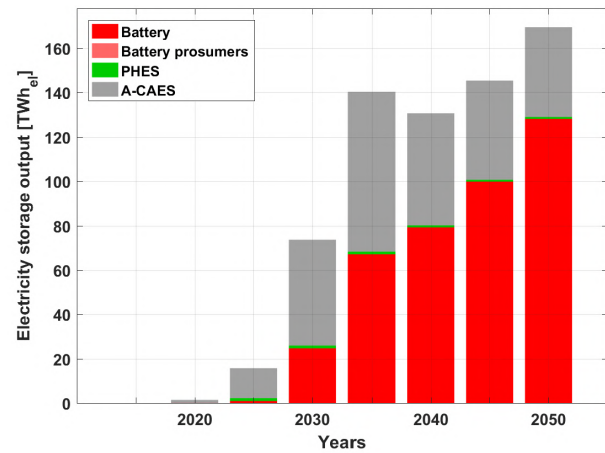
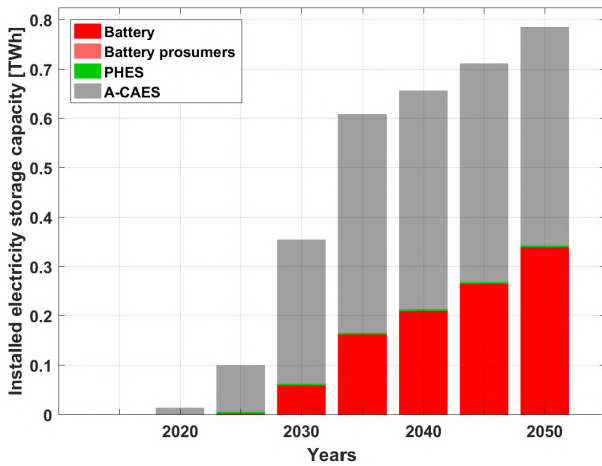

Figure 3.3-16: Eurasia – Transport sector installed electricity storage capacity (left) and electricity storage output (right) during the energy transition from 2015 to 2050.

An essential aspect in the transition of the transport sector towards higher levels of electrification completely based on renewable energy is the production of synthetic fuels, hydrogen and sustainable biofuels. As indicated in Figure 3.3-17, the installed capacities of fuel conversion technologies increase substantially from 2040 onwards to over 460 GW by 2050. Water electrolysis forms the majority share of fuel

conversion capacities through the transition. Additionally, heat is needed during the production of synthetic fuels, mainly for energy-efficient CO₂ direct air capture, and this is enabled by managing process heat, which is otherwise not useable. Heat utilisation is in the range of 280 TWh_{th} by 2050, which is comprised of excess heat and recovered heat, as shown in Figure 3.3-17.

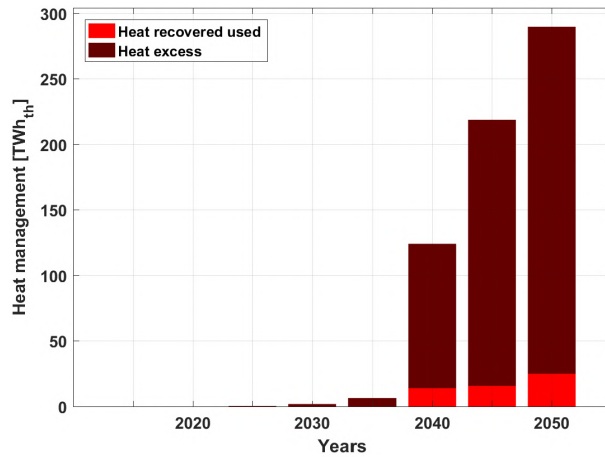
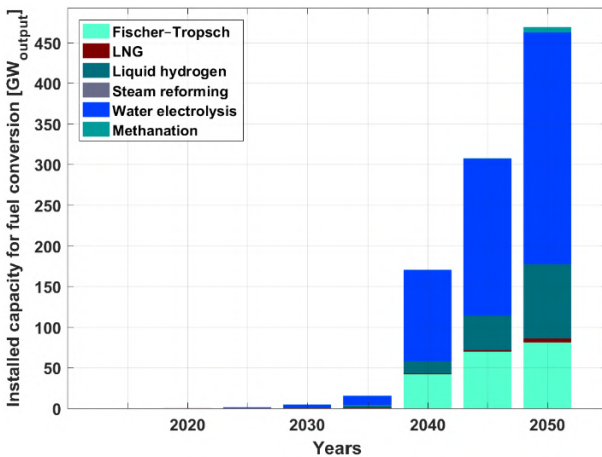

Figure 3.3-17: Eurasia – Transport sector installed capacity for fuel conversion (left) and heat management (right) during the energy transition from 2015 to 2050.

Similarly, gas storage is necessary in the production of synthetic fuels. As shown in Figure 3.3-18, the installed storage capacity for gas increases through the transition to around 3.8 TWh by 2040 and further declines to around 2.7 TWh by 2050. Hydrogen storage is the major gas stored through the transition, with a minor share for methane gas in 2050. CO₂ storage and CO₂ direct air capture, which are vital in the production of synthetic fuels,

are installed from 2040 onwards. The installed capacity for CO₂ storage and CO₂ direct air capture increases up to around 28 MtCO₂ by 2050, as shown in Figure 3.3-18. The major share of installed storage capacity is for CO₂ direct air capture on an annual basis as compared to CO₂ storage. Despite having a lower storage capacity, CO₂ storage has a substantial utilisation and correspondingly higher throughput.

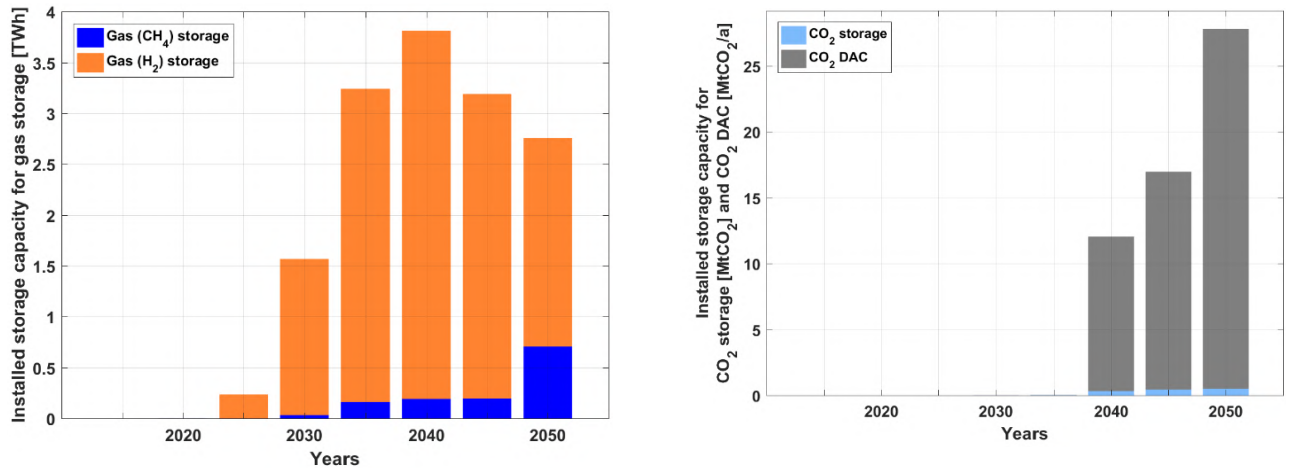

Figure 3.3-18: Eurasia – Transport sector installed capacity for gas (methane and hydrogen) storage (left) and CO₂ direct air capture and CO₂ storage (right) during the energy transition from 2015 to 2050.

Fuel costs are a deciding factor in the overall energy mix for the transport sector across Eurasia and their developing trends are highlighted in Figure 3.3-19. Fischer-Tropsch (FT) and Synthetic Natural Gas (SNG) fuel costs decline through the transition up to 2050. FT fuels are more cost competitive than fossil liquid fuels including GHG emissions costs, which are under 90 €/MWh in 2050. Additionally, SNG is more cost effective than LNG in 2050. Electricity emerges as the most cost

effective option with LCOE primary at around 20 €/MWh and along with complementary costs of storage and other system components, total LCOE is around 33 €/MWh in 2050. H₂ fuel costs decline to be more cost competitive than fossil fuels, in the range of 57 €/MWh in 2050, while liquid H₂ is in the range of 61 €/MWh. CO₂ from DAC is a critical component for synthetic fuels at around 39 €/tCO_{2eq} in 2050, using waste heat, as shown in Figure 3.3-19.

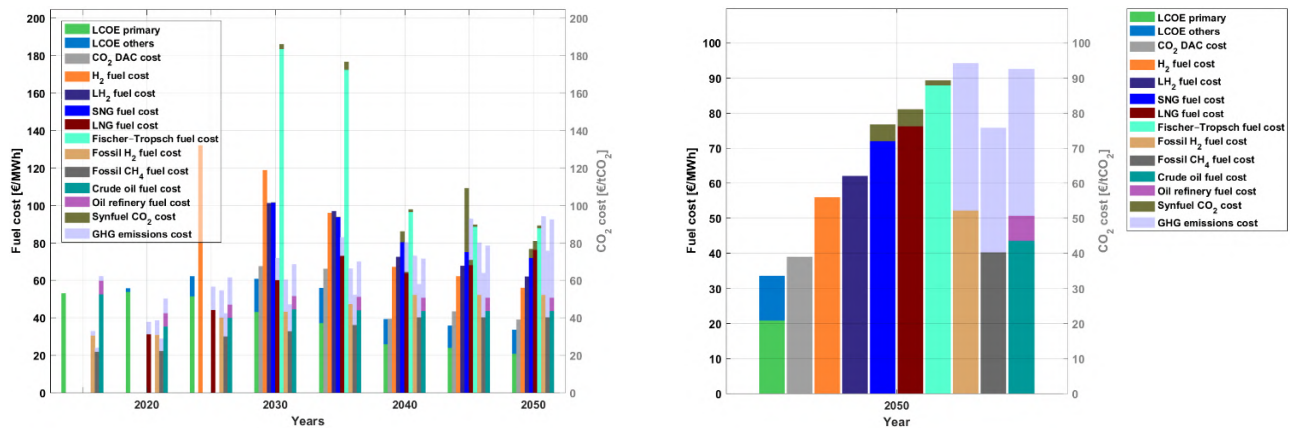

Figure 3.3-19: Eurasia – Fuel costs for the transport sector during the energy transition from 2015 to 2050 (left) and fuel costs in 2050 (right).

The final energy costs for transport are in the range of 80-100 b€ through the transition period with an increase from around 90 b€ in 2015 to about 100 b€ in 2030 and further decline to about 80 b€ by 2050, as shown in Figure 3.3-20. Furthermore, road transport forms a major share of the costs in the initial years up to 2030, beyond which the aviation sector dominates the share of costs, as costs in the road sector decline through the transition. Rail and marine sector costs remain steadier through the

transition. Annual system costs transit from being heavily dominated by fuel costs in 2015 to a very diverse share of costs across various technologies for electricity, synthetic fuels and sustainable biofuel production by 2050, as highlighted in Figure 3.3-20.

The difference in annual final transport energy and system costs is predominantly due to additional aspects of the system beyond 2040, such as FT units producing naphtha as a by-product, which

adds to the overall system costs. The cost for naphtha is allocated to the industry sector as input for the chemical industry, since it is a valuable feedstock.

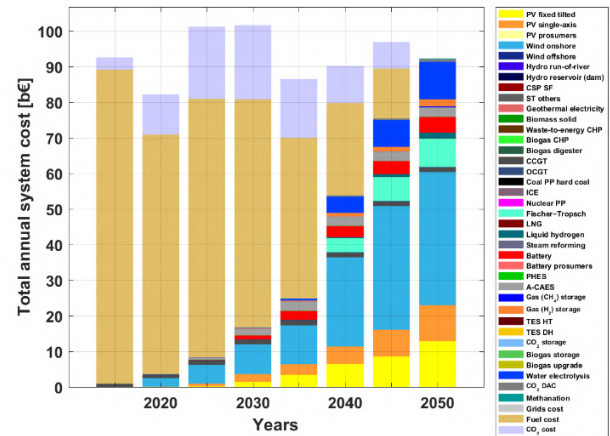
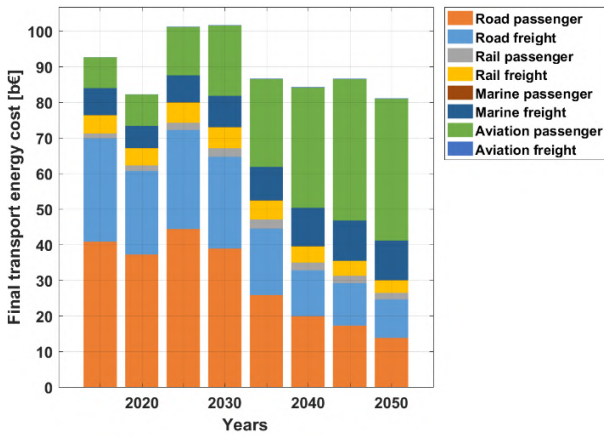

Figure 3.3-20: Eurasia – Final transport energy costs based on mode of transport (left) and source of energy (right) during the energy transition from 2015 to 2050.

The final transport passenger costs decline from around 0.09 €/p-km in 2015 to 0.07 €/p-km by 2050, as shown in Figure 3.3-21. Final transport passenger costs decline for road transport through the transition, whereas for marine and aviation there is a marginal decrease, with rail being stable.

Similarly, final transport freight costs decline from around 0.095 €/t-km in 2015 to 0.025 €/t-km by 2050, as shown in Figure 3.3-21. The final freight costs in the case of road declines through the transition, whereas it increases slightly for aviation and remains stable for rail and marine.

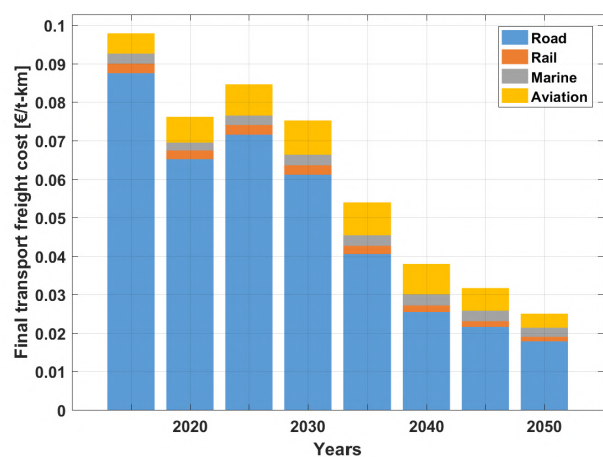
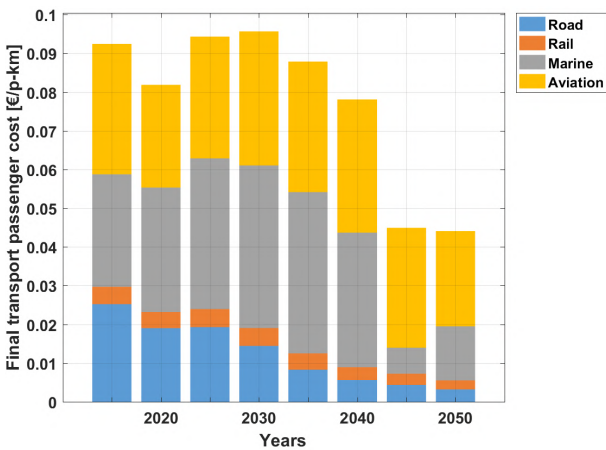

Figure 3.3-21: Eurasia – Final transport passenger cost (left) and final transport freight cost (right) during the energy transition from 2015 to 2050.

Desalination

The desalination demand in Eurasia is relatively small in the initial years, but is seen to increase substantially 2040 onwards with higher demand for desalinated water. Therefore, the installed capacity of power generation for the desalination sector increases from under 20 GW in 2030 to around 850 GW by 2050 as shown in Figure 3.3-22. Solar PV

and wind comprise the majority of installed capacities from 2030 until 2050. Primary electricity generation to meet the desalination demand is from solar PV and wind energy with some shares of fossil gas, which is reduced completely by 2050 as highlighted in Figure 3.3-22.

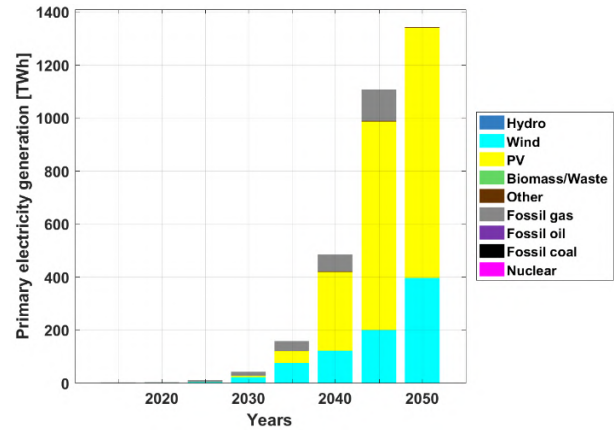
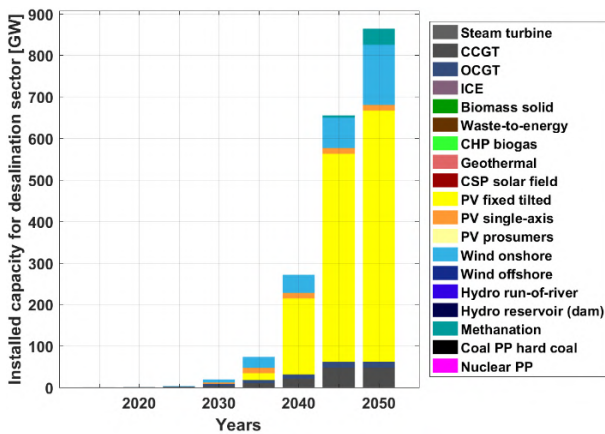

Figure 3.3-22: Eurasia – Technology-wise installed capacities for the desalination sector (left) and primary electricity generation for the desalination sector (right) during the energy transition from 2015 to 2050.

The installed storage capacities for desalination occur mainly from 2035 onwards, with most of the capacity added in the final five-year period until 2050 as shown in Figure 3.3-23. Gas comprises more than 97% of the nearly 110 TWh installed storage capacity in 2050, whereas batteries contribute the majority of the storage output, which reaches more than 400 TWh_{el} by 2050 as shown in Figure 3.3-23.

Investments in power generation for the desalination sector occur mainly from 2030 onwards, as shown in Figure 3.3-24. A majority of the investments is in wind, PV, and batteries, which reaches a high of around 230 b€ in 2040. LCOW increase through the transition from around 1.3 €/m³ in 2015 to over 1.8 €/m³ by 2050, as shown in Figure 3.3-24.

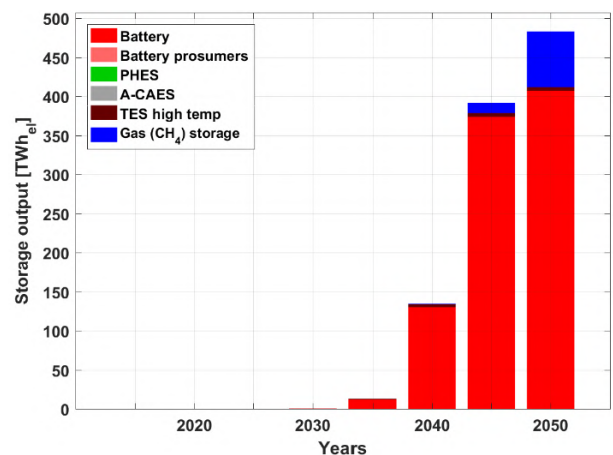
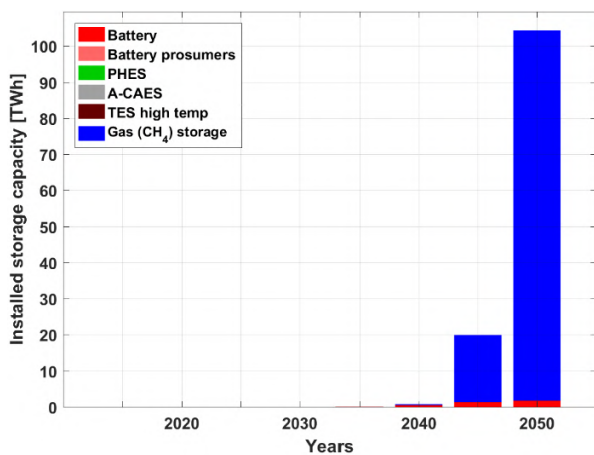

Figure 3.3-23: Eurasia – Installed storage capacity (left) and storage output (right) during the energy transition from 2015 to 2050.

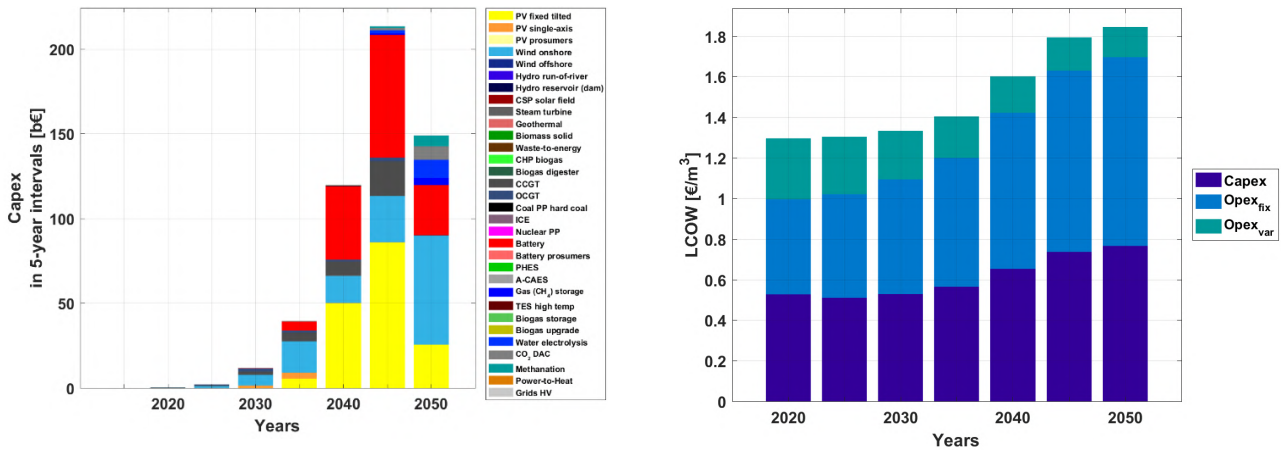

Figure 3.3-24: Eurasia – Capital costs for five-year intervals (left) and levelised cost of water (right) during the energy transition from 2015 to 2050.

Regional Outlook

Electricity generation capacities are installed across Eurasia to satisfy the demand for power, heat, transport, and desalination up to 2050. Wind energy capacities are mainly in the northern and central regions of Eurasia that have much better wind conditions. Whereas, solar PV capacities are predominantly in the southern regions of Eurasia, which have better solar resources throughout the year as shown in Figure 3.3-25. Overall, wind and

solar PV capacities along with some hydropower capacities constitute the majority of installed capacity in 2050 across Eurasia. Similarly, higher shares of wind energy are generated in the northern and eastern regions, while higher shares of solar PV generation occur in the southern regions of Eurasia as highlighted in Figure 3.3-25. This could enhance the complementarity of solar PV and wind in an interconnected Eurasia energy system creating a dynamic energy market across the region.

Regional electricity generation

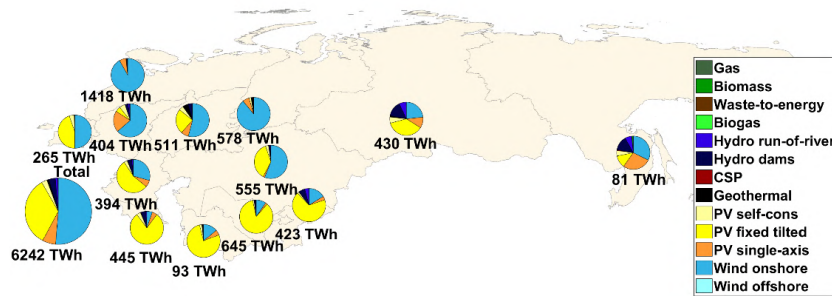

Regional electricity capacities

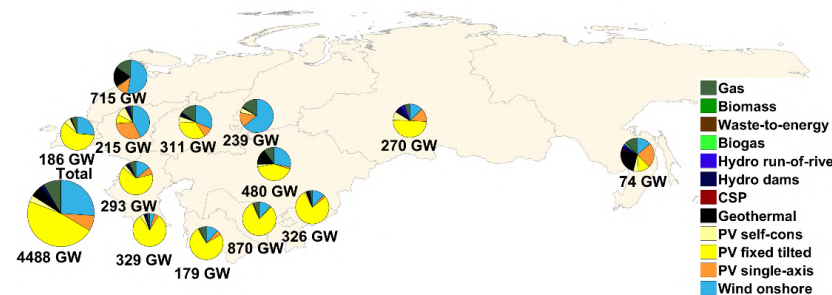

Figure 3.3-25: Eurasia – Regional electricity generation capacities (top) and electricity generation (bottom) in 2050.

Solar PV capacities are well distributed across the different regions of Eurasia and achieve a total installed capacity base of almost 2600 GW in 2050. Moreover, there are higher capacities mostly in the southern countries with good solar condition for most parts of the year, as shown in Figure 3.2-26. Whereas, wind energy capacities achieve a total

installed capacity base of almost 1170 GW in 2050 and are predominantly in the northern regions, which show a strong seasonality effect, i.e. parts of northern and eastern parts of Eurasia implying higher wind energy capacities. This can be observed in Figure 3.3-26.

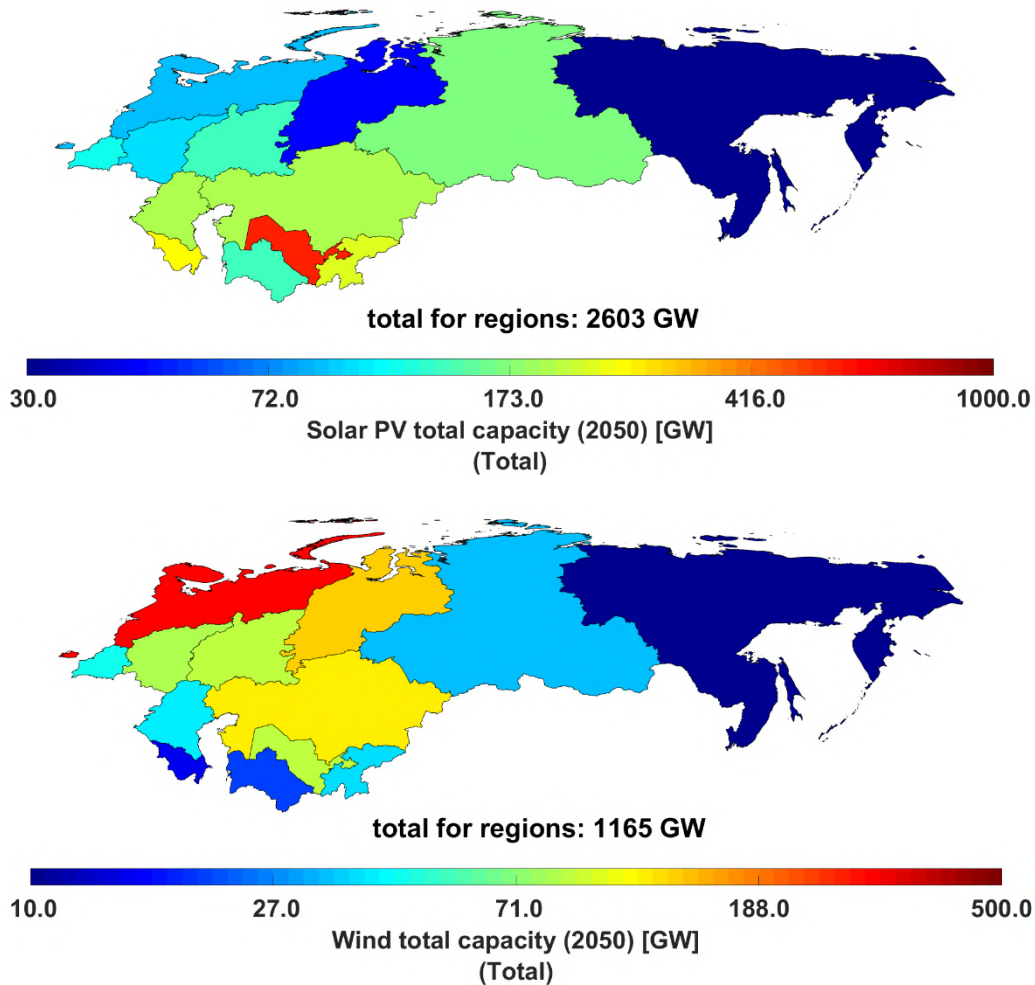

Figure 3.3-26: Eurasia – Regional variation of electricity generation capacities of solar PV (top) and wind energy (bottom) in 2050.

The electricity generation across the power, heat, transport, and desalination sectors of Eurasia are predominantly from wind and solar PV in 2050, which is well distributed across the region as shown in Figure 3.3-27. Solar PV, which supplies a regional average of 47.8% of electricity generation across Eurasia, is more common in the southern regions of

Eurasia. While wind energy, which contributes a regional average of 47.4% of electricity generation across Eurasia, is mainly found in the northern and eastern regions of Eurasia. Overall, solar PV and wind generate most of the electricity needed across Eurasia by 2050, which is around 95.2% of total electricity generation.

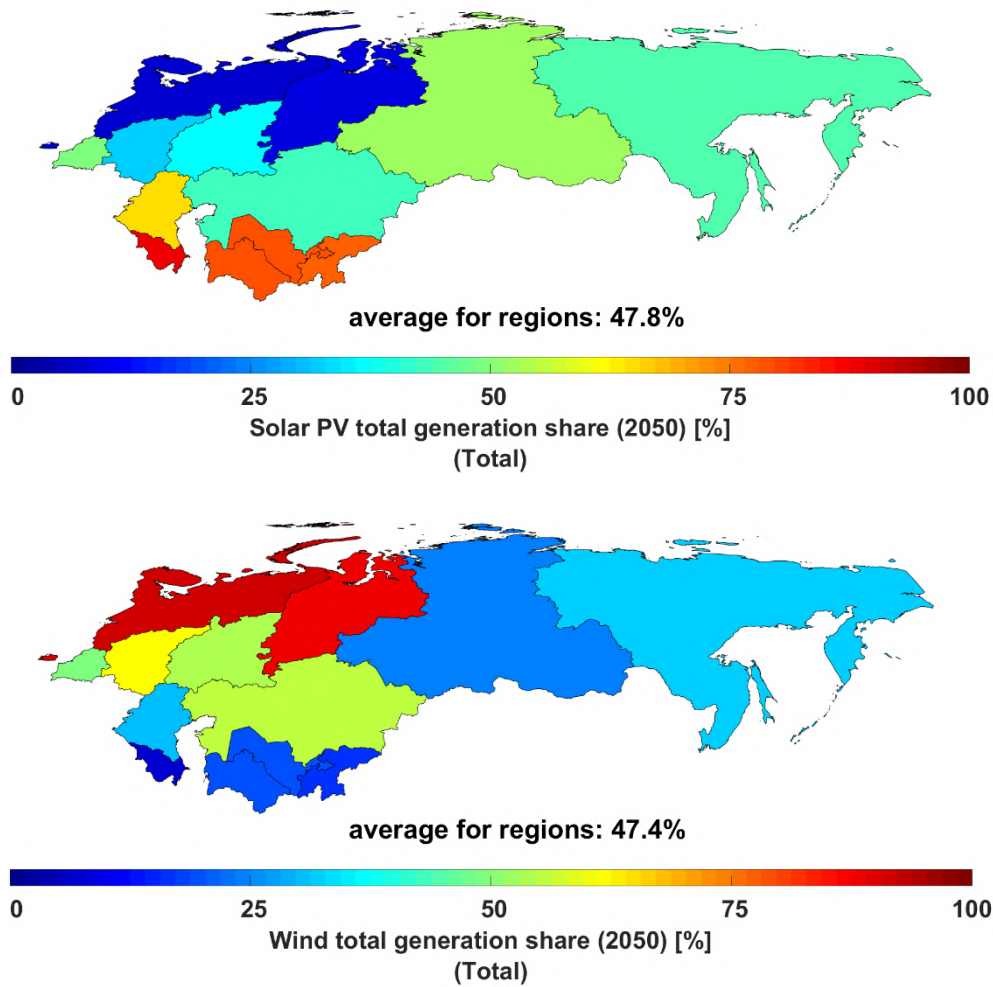
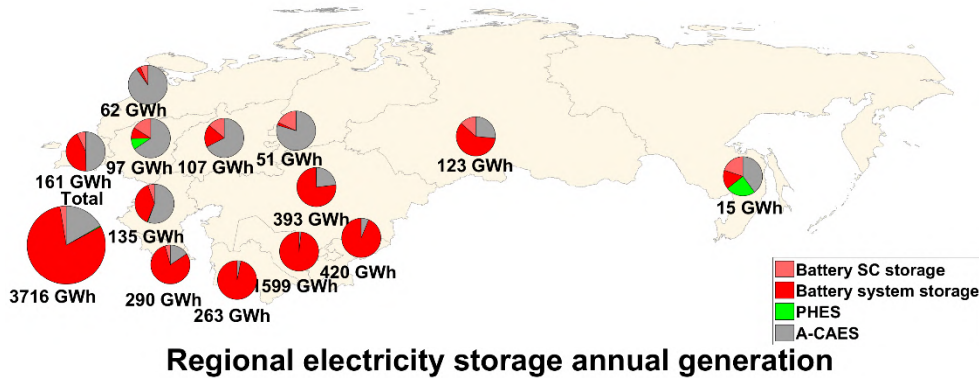

Figure 3.3-27: Eurasia – Regional variation of electricity generation shares of solar PV (top) and wind energy (bottom) in 2050.

Utility-scale and prosumer batteries along with A-CAES contribute a major share of electricity storage capacities, complemented by some shares of PHEs by 2050, as shown in Figure 3.3-28. Storage capacities are much higher in the southern parts of Europe, to complement higher shares of installed solar PV capacities, compared to the northern regions. Batteries, both prosumers and utility-scale,

deliver the largest shares of output by 2050 and are predominant in the southern regions, while A-CAES has higher shares in the northern regions of Eurasia as shown in Figure 3.3-28. PHEs contribute complementary shares of electricity storage output through the transition, across the different regions of Eurasia and more so in the western region.

Regional electricity storage capacities



Regional electricity storage annual generation

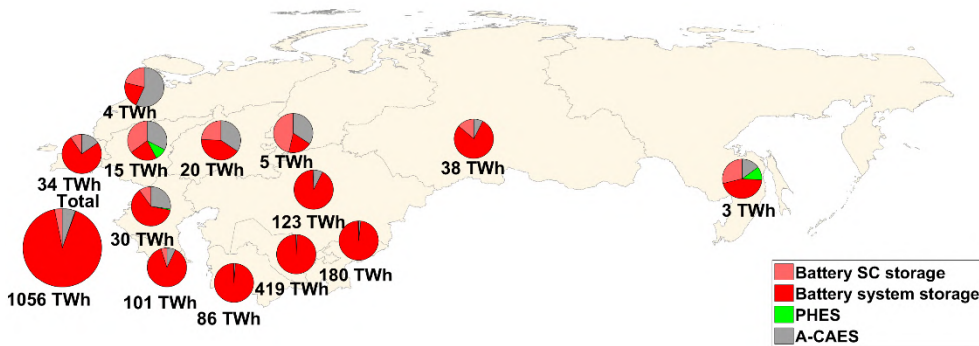

Figure 3.3-28: Eurasia – Regional electricity storage capacities (top) and electricity storage annual throughput (bottom) in 2050.

The storage output across the power, heat, transport, and desalination sectors of Eurasia is predominantly from batteries (both utility-scale and prosumers) and some synthetic natural gas supply in 2050, as shown in Figure 3.3-29. Batteries, which supply a regional average of 15.6% of the storage output across Eurasia, are more common in the

southern regions. Whereas, synthetic natural gas, which supplies an average of 1.3% of the total electricity demand across Eurasia, is also predominant in the southern and eastern regions of Eurasia. This is complemented with a supply share of storage from biomethane of less than 0.1% in 2050 across Eurasia.

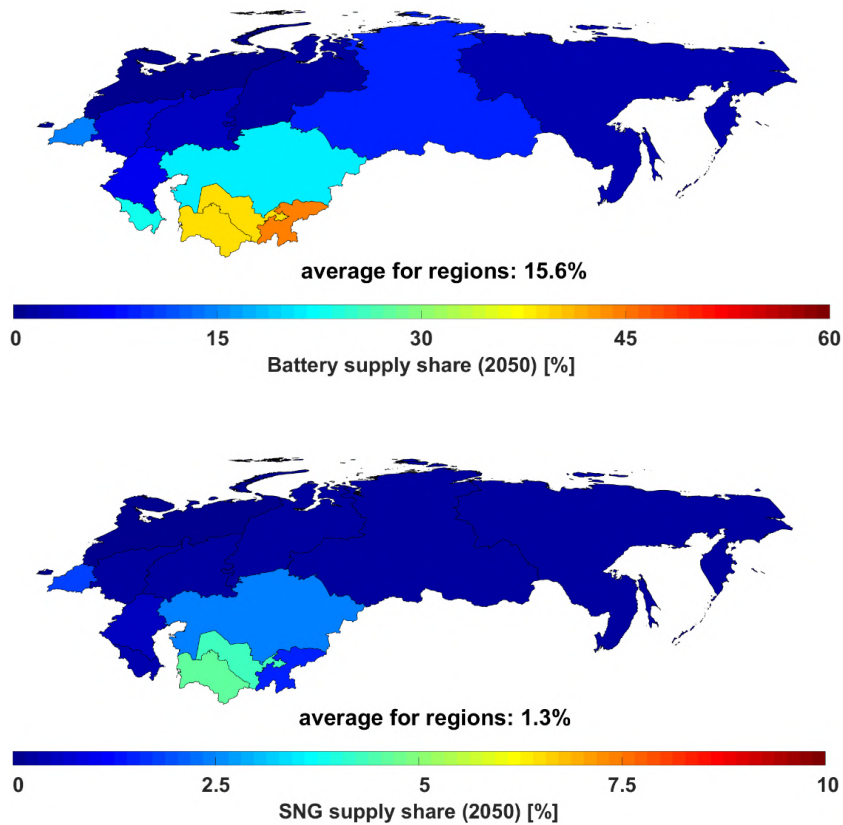

Figure 3.3-29: Eurasia – Regional variation of storage supply shares of batteries (top) and synthetic natural gas (bottom) in 2050.

Greenhouse Gas Emissions

The results of the energy transition towards a 100% renewable energy system indicate a sharp decline in GHG emissions until 2050, reaching zero GHG emissions by 2050 across the power, heat, transport, and desalination sectors in Eurasia as shown in Figure 3.3-30. The power sector

undergoes a deep decarbonisation by 2030, whereas for the heat and transport sectors this occurs mostly between 2030 and 2050. Moreover, the remaining cumulative GHG emissions comprise around 23 GtCO₂eq from 2018 to 2050. Therefore, the energy transition pathway for Eurasia is in adherence to the ambitious Paris Agreement target of 1.5°C.

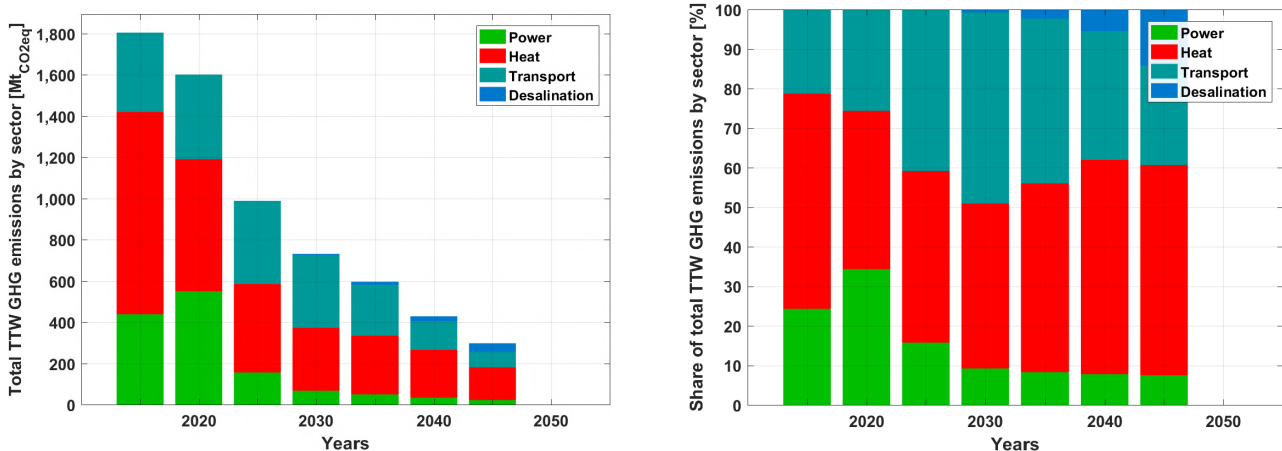

Figure 3.3-30: Eurasia – Sector-wise GHG emissions (left) and the share of GHG emissions of different sectors (right) during the energy transition from 2015 to 2050. Tank to Wheel (TTW) considers GHG emissions from readily available fuels and does not consider GHG emissions from the upstream production and delivery of fuels.

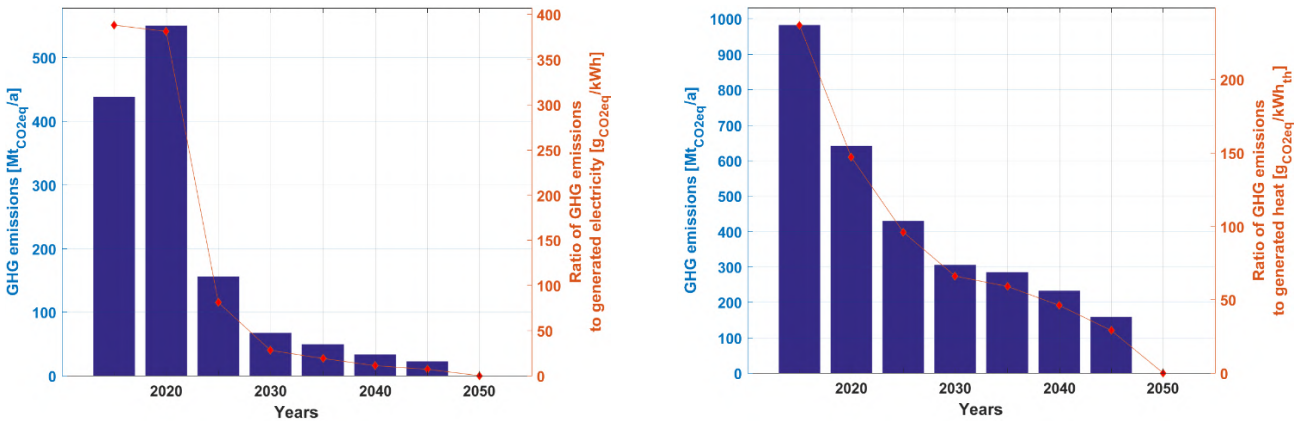

Figure 3.3-31: Eurasia – GHG emissions in the power sector (left) and GHG emissions in the heat sector (right) during the energy transition from 2015 to 2050.

GHG emissions from the power sector after an initial increase, decline through the transition from around 560 MtCO₂ eq./a in 2020 to zero by 2050 as shown in Figure 3.3-31. Similarly, GHG emissions from the heat sector decline through the transition from over 950 MtCO₂ eq./a in 2015 to zero by 2050 as shown in Figure 3.3-31.

GHG emissions from the transport sector after an initial increase, decline through the transition from

over 400 MtCO₂ eq./a in 2015 to zero by 2050, as shown in Figure 3.3-32. Whereas, GHG emissions from the desalination sector increase through the transition from around 1 MtCO₂ eq./a in 2015 to around 42 MtCO₂ eq./a by 2050 and the drop to zero by 2050 as the level of emissions are not as high as in the other sectors, also visible in Figure 3.3-32.

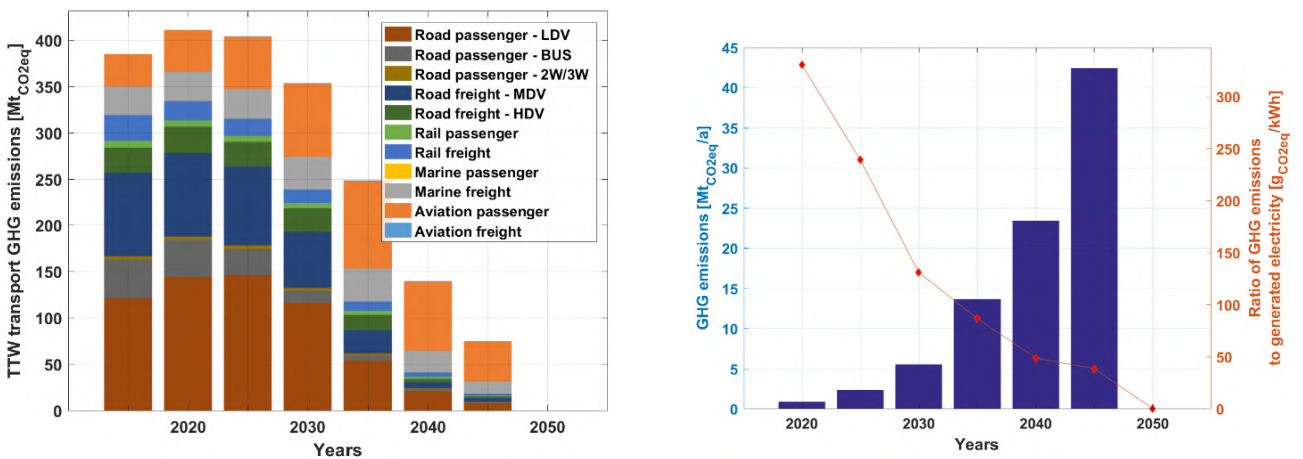

Figure 3.3-32: Eurasia – GHG emissions in the transport sector (left) and GHG emissions in the desalination sector (right) during the energy transition from 2015 to 2050. Tank to Wheel (TTW) considers GHG emissions from readily available fuels and does not consider GHG emissions from the upstream production and delivery of fuels.

Jobs in Power Sector across Eurasia

The total direct energy jobs in this region are set to increase with the initial ramp up of installations from about 566 thousand in 2015 to around 871 thousand by 2025, after a decline in 2030, it is observed to steadily rise to around 925 thousand by 2050. With great potential for wind power, the majority of jobs from 2020 to 2030 is observed to be associated with wind power development creating around 353 thousand jobs in 2025. As solar PV delivers the least cost energy from 2030 onwards, along with driving up installed capacities it emerges as the prime job creator in the region up to 2050, with about 411 thousand jobs as shown in Figure 3.3-33. The hydropower sector with 130 thousand jobs by 2050 is seen to provide a stable number of jobs through the transition period, along with some jobs from geothermal and bioenergy sectors (combined 75 thousand jobs by 2050). Jobs associated with the storage sector begin to develop from 2040 onwards, but remain relatively low compared to other regions with just about 58 thousand jobs by 2050, as hydropower in combination with robust transmission networks play a prominent role in reducing the need for storage.

Local manufacturing, construction and installation of renewable energy technologies create a

significant share of jobs enabling the rapid build-up of capacities up to 2025 (508 thousand jobs), this is also due to the fact that most conventional power plants in this region are quite old and nearing their end of lifetimes. This could serve as a co-benefit of the energy transition for countries across Eurasia. Beyond 2030, a stable number of jobs will be created in these sectors up to 2050 with around 407 thousand jobs. Fuel jobs after an initial increase in 2020 (40% of total jobs), decline through the transition period as capacities of conventional power plants are replaced by renewables until 2030 and further decline up to 2050 reaching just about 2% of total jobs. On the contrary, operation and maintenance jobs continue to grow through the transition period and become the major job creating segment by 2050, with 51% of total jobs. As operation and maintenance jobs last through the lifetime of power plants, they offer relatively stable long-term job prospects. As indicated in Figure 3.3-33, the electricity demand specific jobs was at 516 jobs/TWh_{el} in 2015 and increases to 859 jobs/TWh_{el} in 2025 with the rapid ramp up in renewable energy installations. Beyond 2025, it declines steadily to 638 jobs/TWh_{el} by 2050.

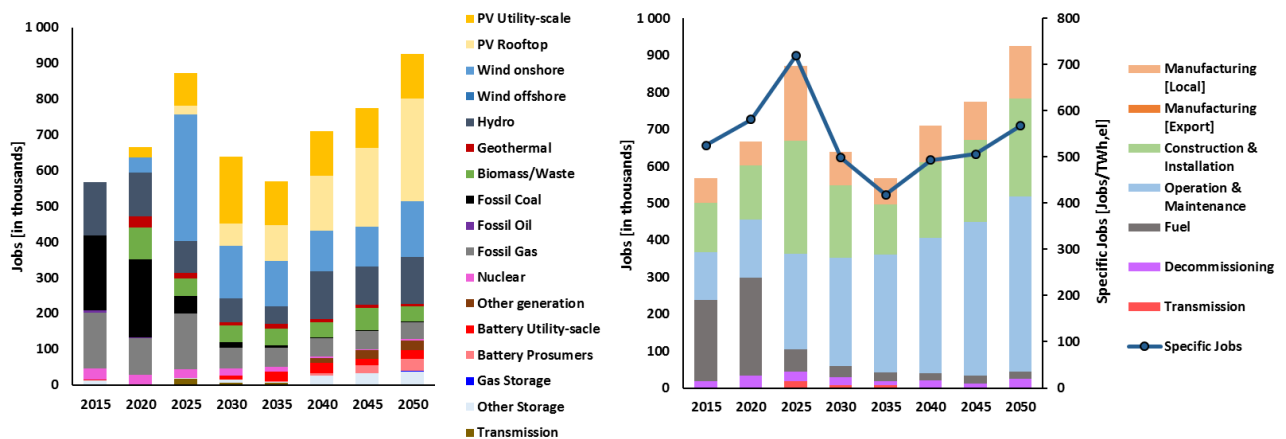

Figure 3.3-33: Eurasia – Jobs created by various power generation and storage technologies (left) and jobs created based on different categories with the development of electricity demand specific jobs (right) during the energy transition from 2015 to 2050.

3.4. Middle East and North Africa (MENA)

The Middle East and North African (MENA) region is a mix of emerging economies as well as developed countries, with 7% share in global GDP⁶³. Population in MENA is 423 million in 2015 representing a share of 6% in world population, which is estimated to be 7% in 2050. It is one of the biggest energy resource extraction hubs worldwide, but also has increasingly high demands. The substantial link between fossil fuels and socio-economic development make the region highly vulnerable to the impacts of climate change. As global temperatures continue to rise, it will have detrimental effects on the region, such as increasing the temperature above average and decreasing precipitation, which will lead to a rise in demand for water desalination and air conditioning, in a region that is amongst the most water-stressed across the world²⁷. There are growing concerns that a threshold temperature could be exceeded, which would overstretch human adaptability and result in the region being

uninhabitable for humans⁶⁷. In addition, governments and decision makers across the MENA region aim to decrease the risk of reliance on fossil fuel revenues, including fluctuations in oil prices and global market volatility. In this context, renewables have a major role in ensuring a sustainable and affordable energy supply for the region, and the results indicate an incremental transition towards 100% renewable energy systems across the MENA region. The detailed results for the energy transition across MENA are available in a supplementary data file, the link for the file can be found in the Appendix.

Penetration of renewables is not just a matter of replacing hydrocarbons with zero-carbon sources of energy supply – it also represents a significant change in resource efficiency. This is illustrated by the overall electrification across the power, heat, transport, and desalination sectors as shown in Figure 3.4-1.

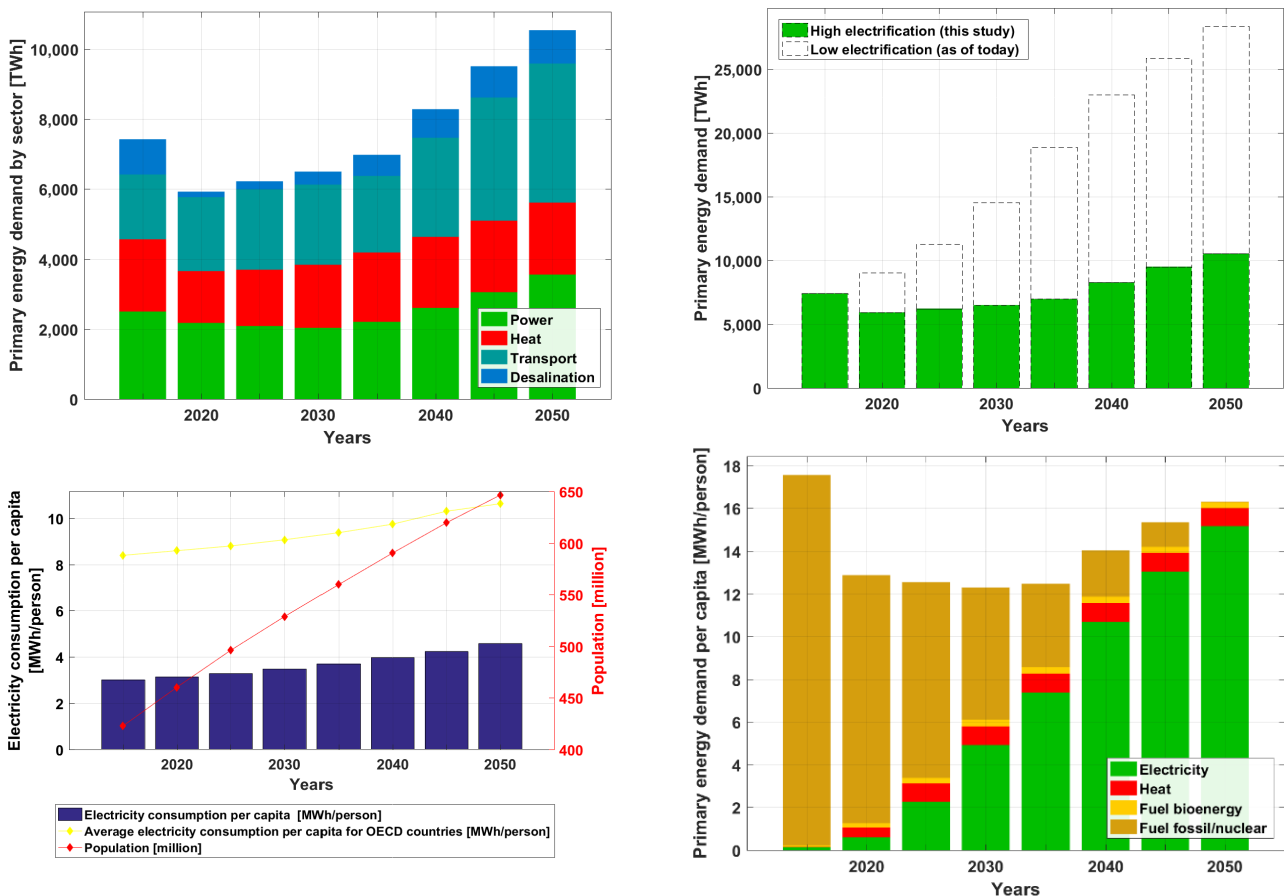

Figure 3.4-1: MENA – Primary energy demand sector-wise (top left), efficiency gain in primary energy demand (top right), electricity consumption per capita with population (bottom left) and primary energy demand per capita (bottom right) during the energy transition from 2015 to 2050.

The primary energy demand assuming high electrification, which is the basis for this study, decreases from 7,800 TWh in 2015 to around 6,200 TWh by 2035 and increases up to 10,500 TWh by 2050 as shown in Figure 3.4-1. On the contrary, with low shares of electrification resulting from the adoption of current practices until 2050, the primary energy demand reaches nearly 28,000 TWh by 2050. The massive gain in energy efficiency is primarily due to a high level of electrification of more than 90% resulting in the reduction of around 17,500 TWh by 2050, in comparison to the continuation of current practices with low shares of electrification. The population across MENA is expected to grow from 423 to 646 million by 2050. Correspondingly, the average per capita primary energy demand decreases from around 18 MWh/person in 2015 to 12 MWh/person by 2035 and increases up to more than 16 MWh/person by 2050. However, a higher demand for desalinated water, as well as increased levels of air-conditioning induced by growing building space per person, reduces the overall gains and contributes to an increase in energy demand in the later years of the transition, from 2035 to 2050. In the transport

sector, the relatively low costs of car ownership and high status of owning private cars in the MENA region, drive higher levels of car use by households in the future. Additionally, substantial demand for fuel conversion technologies arise beyond 2040, in producing renewable-based fuels for the transport sector across MENA.

Energy Supply

The electricity generation capacity satisfies demand from all energy sectors including power, heat, transport and desalination. The total installed capacity grows massively from over 250 GW in 2015 to around 5300 GW by 2050 as shown in Figure 3.4-2. In the initial period of the transition, a larger share of wind capacities are installed up to 2030, but in the later part of the transition solar PV dominates the shares of installed capacities reaching almost 4630 GW by 2050. On the other hand, the shares of fossil fuels and nuclear decline through the transition to zero by 2050. Some shares of gas remain, but the fuel switches from fossil-based gas to synthetic natural gas produced with renewable electricity and biomethane.

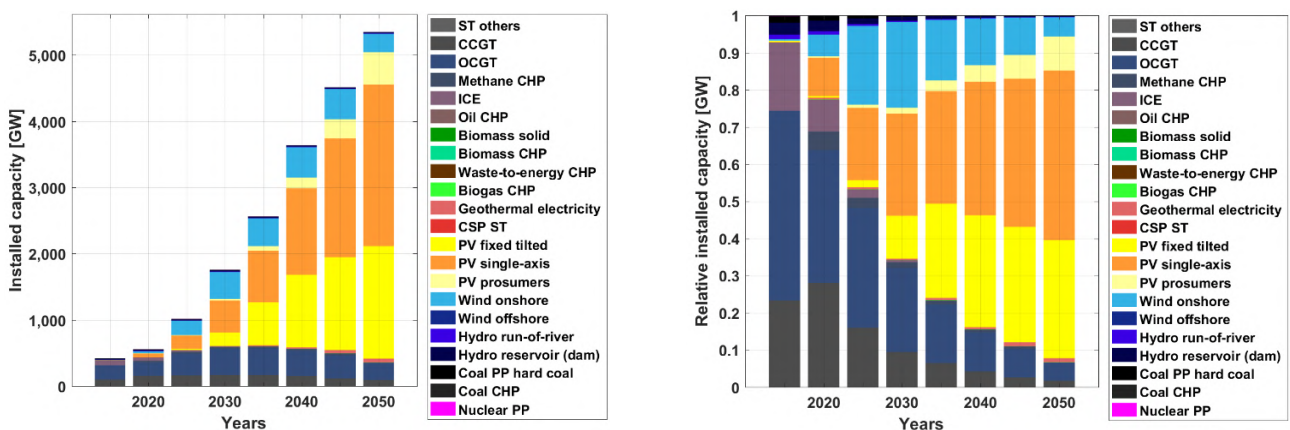

Figure 3.4-2: MENA – Technology-wise installed capacities (left) and technology-wise shares of installed capacities (right) during the energy transition from 2015 to 2050.

Electricity generation from various technologies to cover the demand of power, heat, transport, and desalination sectors is shown in Figure 3.4-3. Solar PV supply increases through the transition from 42% in 2030 to over 90% by 2050, becoming the lowest cost energy source. Wind energy increases to 38% by 2030 and declines through the transition to around 8% 2050. In the heat sector, heat pumps play a significant role through the transition with a share of around 37% of heat generation by 2050 on

both the district and individual levels, as indicated in Figure 3.4-3. On the other hand, gas-based heating decreases through the transition from over 53% in 2015, to around 14% by 2050. Fossil gas is eliminated and replaced by synthetic gas produced from renewable energy. Additionally, fossil fuel-based heating decreases through the transition period as oil-based DH and IH are replaced by electric heating, solar thermal, biomass-based DH and IH and geothermal energy.

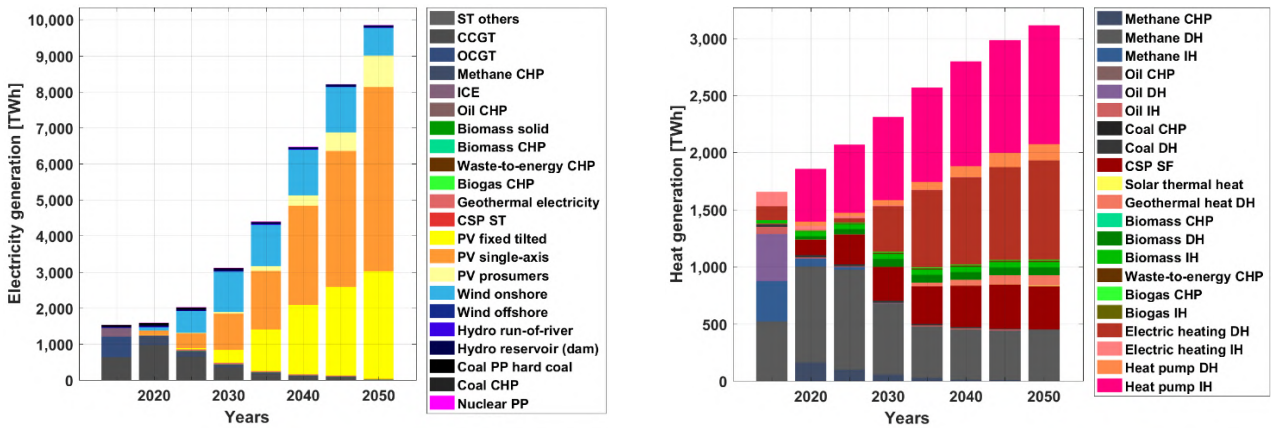

Figure 3.4-3: MENA – Technology-wise electricity generation (left) and technology-wise heat generation (right) during the energy transition from 2015 to 2050.

Energy Storage

Energy storage technologies play a critical role in enabling a secure energy supply throughout MENA, fully based on renewable energy across different sectors. As highlighted in Figure 3.4-4, storage output covers over 3000 TWh_{el} of total electricity demand in 2050. The ratio of electricity demand covered by energy storage to electricity generation increases significantly to over 10% by

2030 and increase further to more than 30% by 2050. Additionally, over 5% is covered by heat storage conversion to electricity by 2050. Batteries emerge as the most relevant electricity storage technology contributing about 90% of the total electricity storage output by 2050. In addition, a significant share of gas storage is installed to provide seasonal storage primarily during the cold winter season mainly in the northern regions of MENA.

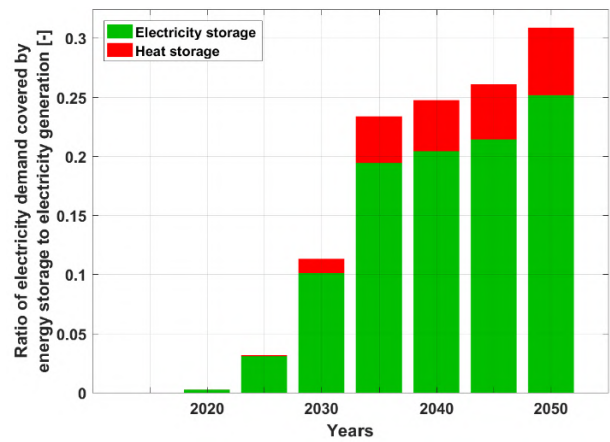
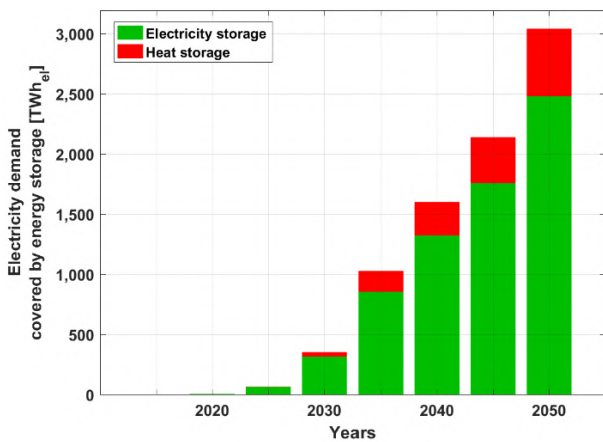
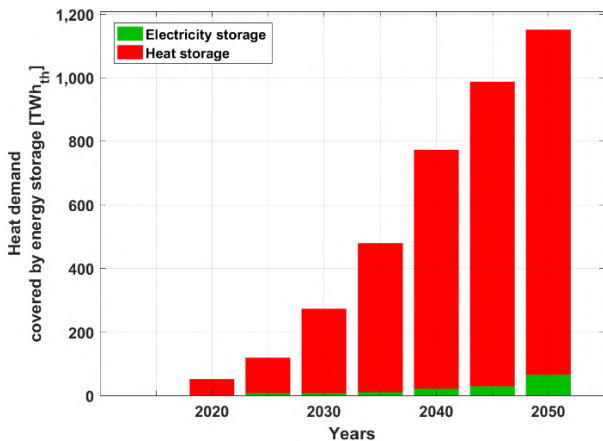

Figure 3.4-4: MENA – Electricity demand covered by energy storage (left) and ratio of electricity demand covered by different forms of energy storage (right) during the energy transition from 2015 to 2050.

Similarly, heat storage plays a vital role in ensuring heat demand is covered across all the sectors. As indicated in Figure 3.4-5, storage output covers over 1,100 TWh_{th} of the total heat demand in 2050 and heat storage technologies are crucial to meet this demand. The ratio of heat demand covered by energy storage to heat generation increases substantially to over 30% by 2050, also shown in

Figure 3.4-5. Thermal energy storage (TES) emerges as the most relevant heat storage technology with around 40-60% of heat storage output from 2030 until 2050. Furthermore, PtG contributes around 40% of heat storage output in 2050. In addition, electricity storage to heat contributes a minor share of the head demand through the transition.



increases through the transition, as fuel costs

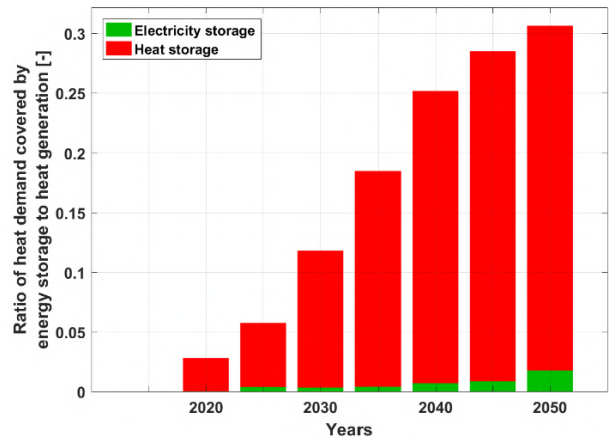

Figure 3.4-5: MENA – Heat demand covered by energy storage (left) and the ratio of heat demand covered by different forms of energy storage (right) during the energy transition from 2015 to 2050.

Costs and Investments

The total annual costs are in the range of 290-520 b€ through the transition period and well distributed across the major sectors of Power, Heat and Transport, and a smaller share for desalination, which is relatively higher in MENA compared to other regions of the world. As indicated by Figure 3.4-6, power, heat, and transport costs are in the range of around 280-480 b€ through the transition. In addition, as highlighted in Figure 3.4-6 CAPEX

decline. The steady increase in CAPEX-related energy system costs indicate that fuel utilisation and the respective negative impacts on trade balances will fade out through the transition. In addition, lower fuel export dependency will lead to higher levels of energy diversification across MENA.

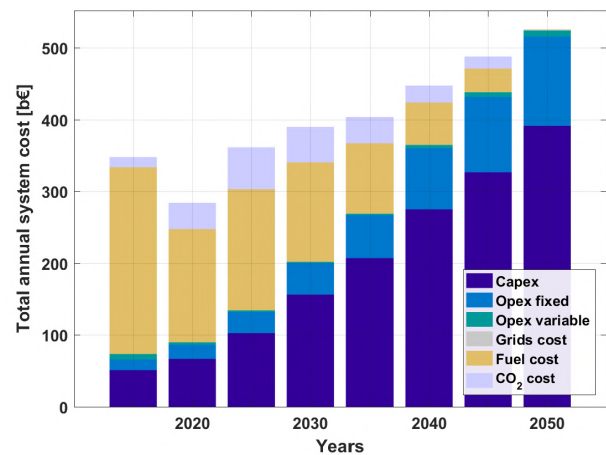
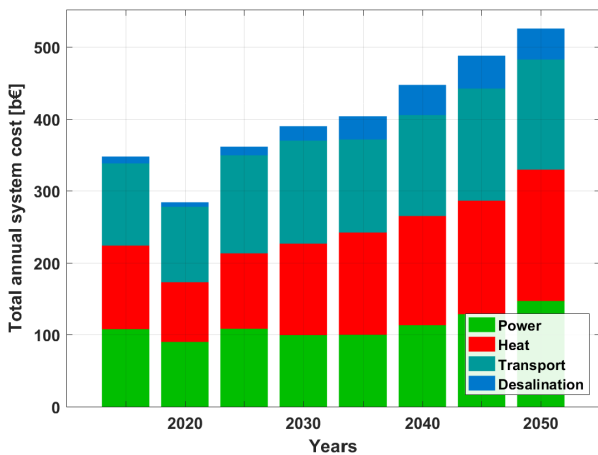

Figure 3.4-6: MENA – Annual system costs, sector-wise (left) and functionality-wise (right) during the energy transition from 2015 to 2050.

As indicated in Figure 3.4-7, levelised cost of energy declines substantially from around 75 €/MWh in 2015 to over 55 €/MWh in 2050 and is increasingly dominated by capital costs as fuel costs continue to decline through the transition period, which could mean increased levels of energy diversification across MENA by 2050.

Capital costs are well spread across a range of technologies with major investments for PV, wind energy, batteries, heat pumps, and synthetic fuel conversion technologies up to 2050, as shown in Figure 3.4-7. The cumulative investments are about 5,000 b€ through the transition from 2016-2050.

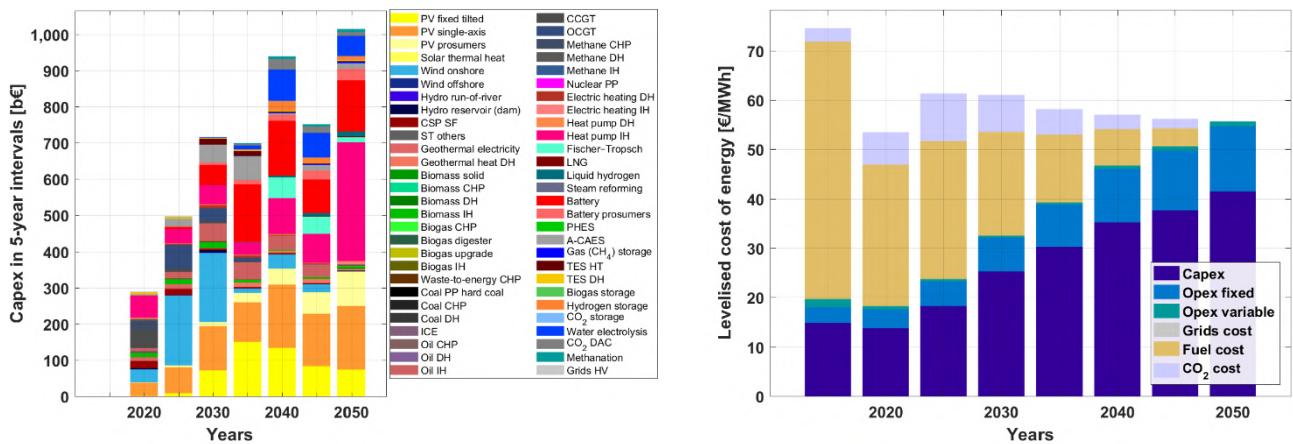

Figure 3.4-7: MENA – Capital costs for five-year intervals (left) and levelised cost of energy (right) during the energy transition from 2015 to 2050.

Outlook across Sectors

Different trends in the power, heat, transport, and desalination sectors across MENA emerge through the transition. As the sectors transition towards higher shares of renewable energy, different technologies have vital roles in ensuring the stability of the energy system. A closer look at the individual sectors provides further insights into the energy transition across MENA towards 100% renewable energy.

Power and Heat

The total installed power generation capacities increase from nearly 400 GW in 2015 to around 2,800 GW by 2050, as shown in Figure 3.4-8. Across the power sector, solar PV with 2,300 GW

and wind with 140 GW constitute the majority of installed capacities by 2050. In the heat sector, heat pumps, electric heating, and some shares of solar thermal along with biomass and oil-based heating constitute the majority of installed capacities by 2050, also shown in Figure 3.4-8. The demand for heat sector is marginally increasing over the transition. Therefore, oil IH with a relatively low CAPEX is installed up to the year 2050 with a very low or zero FLH, despite its high OPEX. A significant increase in installed capacities of heat pumps and biomass-based heating occurs in the final five-year period leading up to 2050, as fossil fuels are completely eliminated from the energy system.

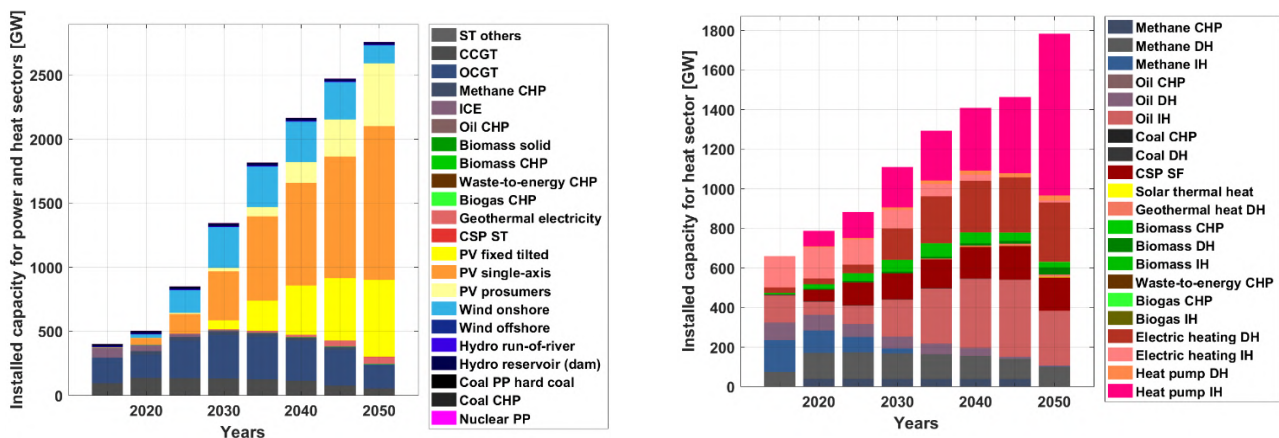
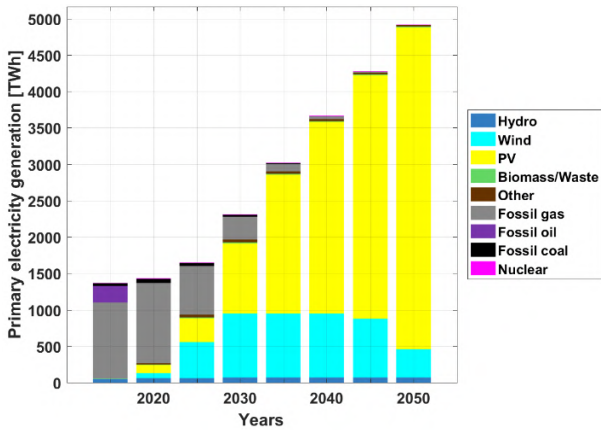

Figure 3.4-8: MENA – Technology-wise installed capacities for power (left) and heat (right) during the energy transition from 2015 to 2050.

The transition across MENA results in a power and heat sector dominated by fossil fuels in 2015 moving towards a solar PV and wind energy dominated sector by 2050, with some hydropower as shown in Figure 3.4-9. The primary electricity generation increases from around 1,400 TWh in 2015 to around 4,900 TWh by 2050, which is



primarily from PV and wind. Heat generation increases from over 1,600 TWh in 2015 to around 3,100 TWh by 2050, which is predominantly from heat pumps and electric heating with some solar thermal, non-fossil gas and biomass-based heating, also shown in Figure 3.4-9.

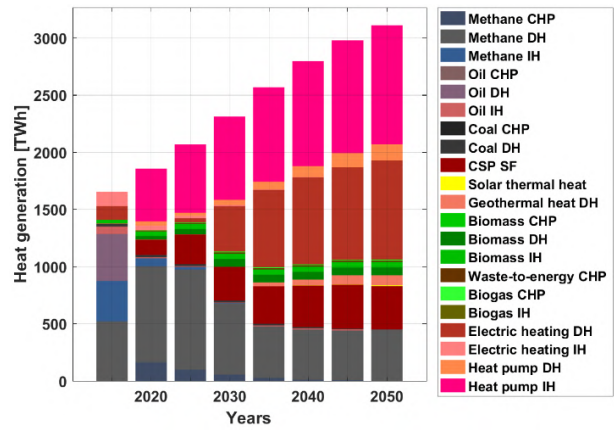

Figure 3.4-9: MENA – Primary electricity generation (left) and technology-wise heat generation (right) during the energy transition from 2015 to 2050.

The installed electricity storage capacity increases through the transition to over 5.5 TWh by 2050, as shown in Figure 3.4-10. Utility-scale and prosumer batteries with some shares of A-CAES are installed through the transition. The installed capacities of A-CAES are also a consequence of the modelling approach, which prioritises full domestic energy supply for all MENA regions. The installed heat storage capacity increases mainly from 2040

onwards with a massive capacity addition of gas storage of nearly 70 TWh by 2050, as shown in Figure 3.4-10. In addition, some minor shares of TES are installed which have relatively higher heat output. The substantial gas storage capacity addition is mainly to provide seasonal storage across MENA covering the heat demand in the absence of fossil fuels.

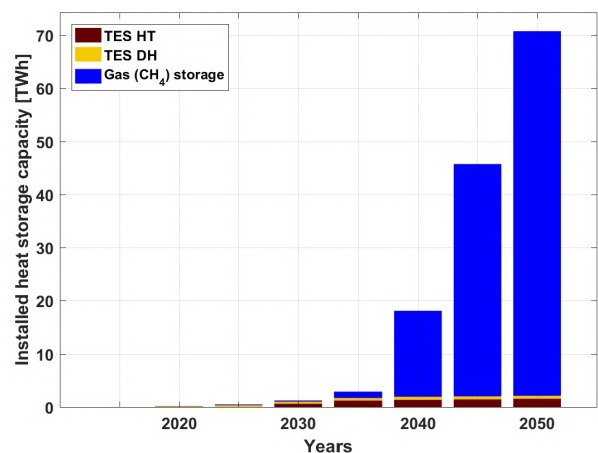
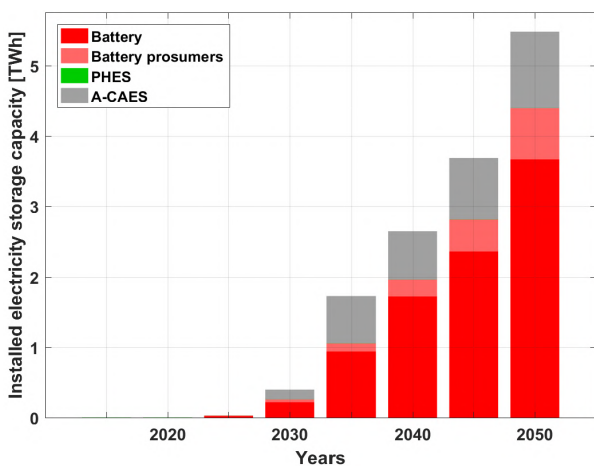

Figure 3.4-10: MENA – Installed electricity storage capacities (left) and heat storage capacities (right) during the energy transition from 2015 to 2050.

Utility-scale and prosumer batteries contribute a major share of the electricity storage output with nearly 90% by 2050, as highlighted by Figure 3.4-11. In addition, A-CAES contributes some shares through the transition. TES emerges as the most relevant heat storage technology with around 40-

60% of heat storage output from 2020 until 2050, also seen in Figure 3.4-11. Gas storage contributes more than 50% of the heat storage output in 2050 covering predominantly seasonal demand, previously covered by fossil gas.

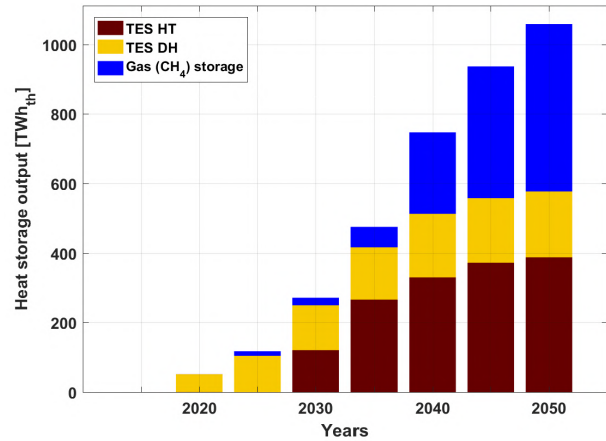
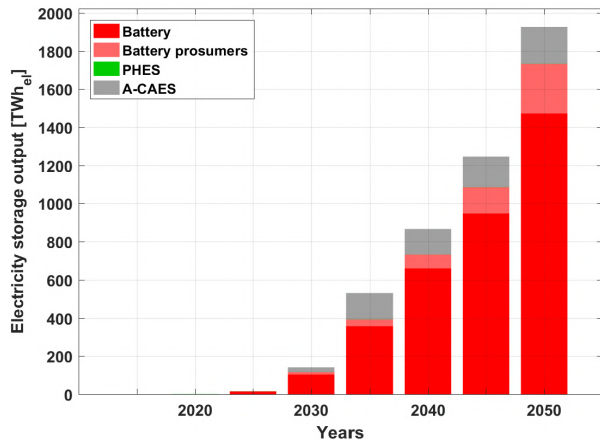

Figure 3.4-11: MENA – Electricity storage output (left) and heat storage output (right) during the energy transition from 2015 to 2050.

The LCOE of the power sector decreases substantially from around 98 €/MWh in 2015 to around 52 €/MWh by 2050, as shown in Figure 3.4-12. LCOE is predominantly comprised of CAPEX as fuel costs decline through the transition. The LCOH of the heat sector decreases from around 69

€/MWh in 2015 to around €54/MWh by 2030 and further increases marginally to around 58 €/MWh by 2050, as shown in Figure 3.4-12. LCOH is predominantly comprised of CAPEX as the share of fuel costs decline through the transition.

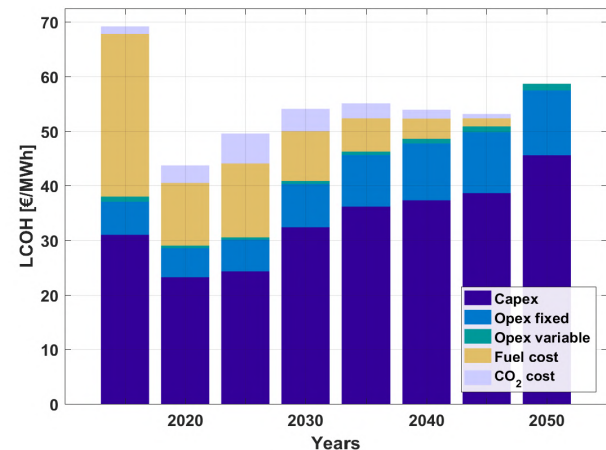
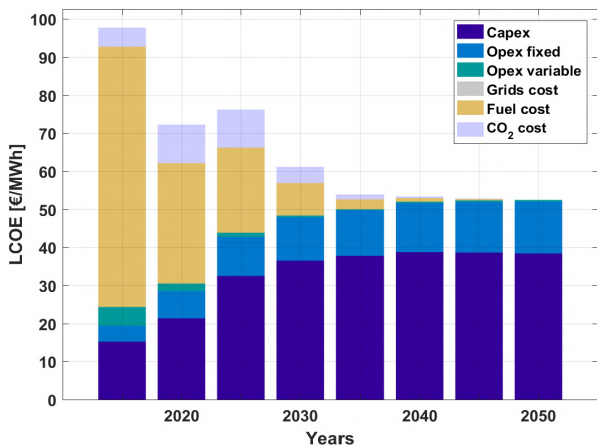

Figure 3.4-12: MENA – Levelised cost of electricity (left) and levelised cost of heat (right) during the energy transition from 2015 to 2050.

Investments are well spread across a range of power generation technologies with the majority share in wind energy up to 2030, beyond which solar PV dominates investments up to 2050, as shown in Figure 3.4-13. Investments in the heat sector are mainly in heat pumps and some shares in

solar thermal, oil IH and biomass heating up to 2045, also shown in Figure 3.4-13. The steep increase in heat pump investments in the final five-year period until 2050 is mainly to cover the heat demand in the absence of fossil fuels as well as the lower costs of heat pumps by 2050.

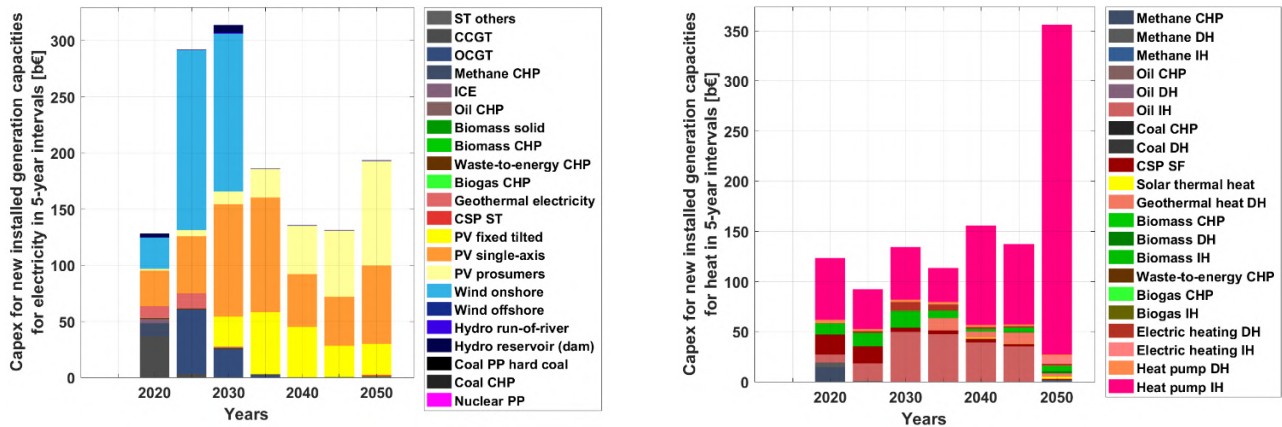

Figure 3.4-13: MENA – Capital costs of installed generation capacities in five-year intervals for electricity (left) and heat (right) during the energy transition from 2015 to 2050.

Transport

The final energy demand of the transport sector across MENA is around 1,800 TWh in 2015. However, this demand increases through the transition to around 2,500 TWh as shown in Figure 3.4-14. Despite a substantial increase in transport activities, the energy demand increase is relatively low, mainly due to the efficiency gains brought about by higher levels of electrification in the sector. Fossil fuel consumption in the transport sector across MENA is seen to decline through the

On the other hand, liquid fuels produced by renewable electricity contribute around 28% of final energy demand in 2050. In addition, hydrogen constitutes more than 27% of final energy demand in 2050. Sustainably produced biofuels contribute a minor share to enable a complete elimination of fossil fuel usage in the transport sector. Electrification of the transport sector creates an electricity demand of around 3,800 TWh_{el} by 2050. The massive demand for liquid fuels kicks in from 2040 onwards up until 2050, as indicated in Figure 3.4-14.

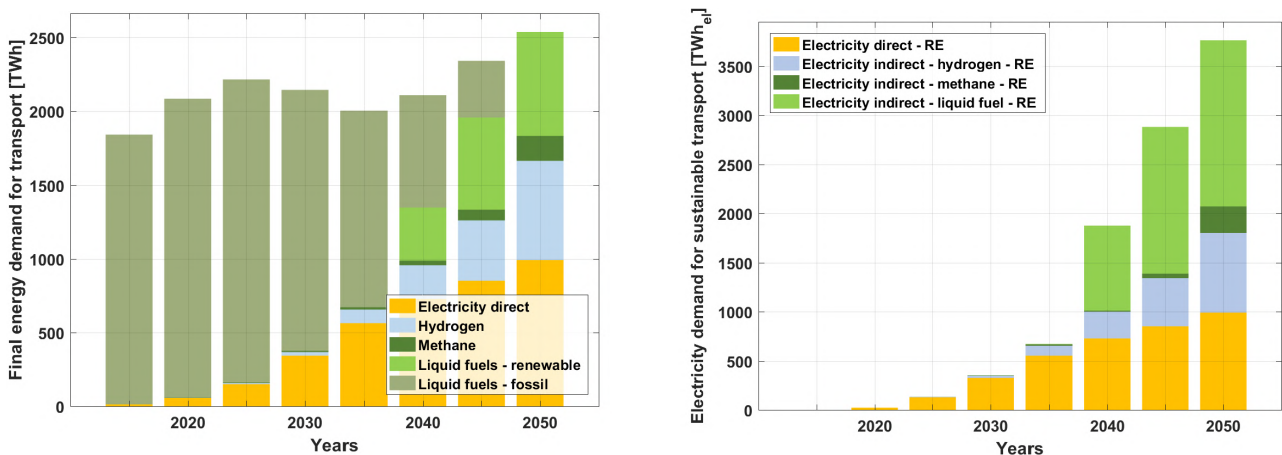

Figure 3.4-14: MENA – Final energy demand for transport (left) and electricity demand for sustainable transport (right) during the energy transition from 2015 to 2050.

transition from about 99% in 2015 to zero by 2050.

Installed power generation capacities for the transport sector increase substantially through the transition to around 2,000 GW by 2050, as shown in Figure 3.4-15. Solar PV and wind form the majority share of the power generation capacities for the transport sector, as they are the lowest cost energy sources by 2050. Most of the capacity addition happens from 2035 onwards, with a rapid

change in the transport sector towards increased electrification in the later part of the transition. Similarly, electricity generation increases substantially up to almost 4,000 TWh by 2050, also seen in Figure 3.4-15. Solar PV and wind energy generate all the electricity required to meet the demand of the transport sector in 2050.

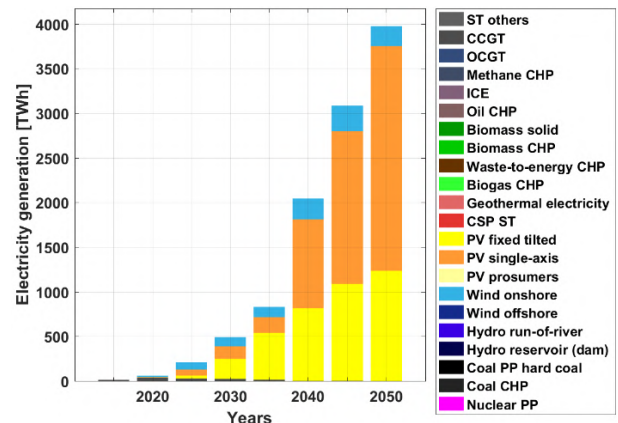
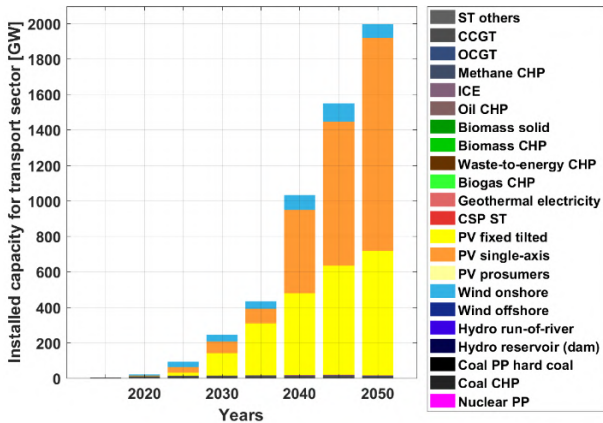

Figure 3.4-15: MENA – Transport sector installed power generation capacity (left) and electricity generation (right) during the energy transition from 2015 to 2050.

A critical aspect to complement the electrification of the transport sector is the installation of storage technologies. As seen in Figure 3.4-16, the installed capacities of electricity storage increase through the transition to around 2.3 TWh by 2050. The majority of installed capacities are utility-scale batteries and A-CAES. Similarly, electricity storage output increases through the transition to over 750 TWh_{el} by 2050 as shown in Figure 3.4-16. Utility-

scale batteries play a vital role as they contribute a major portion of the output through the transition, with over 550 TWh_{el} by 2050. The relatively low electricity storage of less than 20% of generated electricity for the transport sector is enabled by the flexible operation of batteries, water electrolyser units, and hydrogen buffer storage for synthetic fuel production.

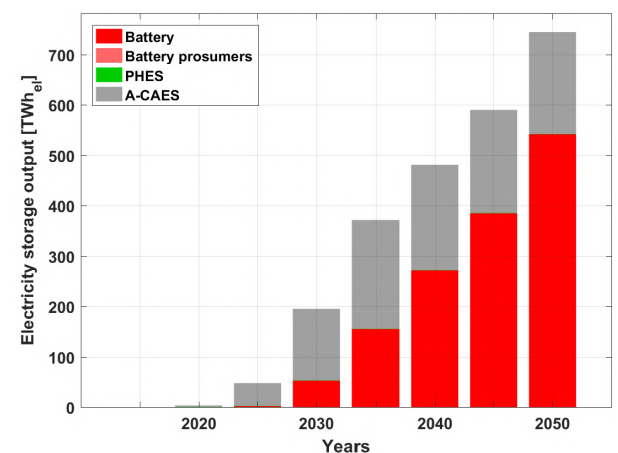
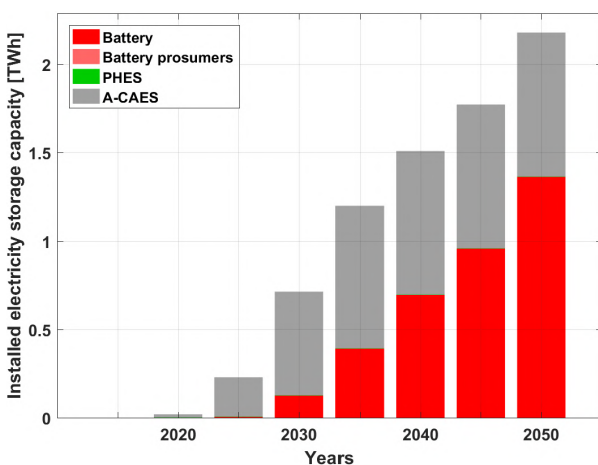

Figure 3.4-16: MENA – Transport sector installed electricity storage capacity (left) and electricity storage output (right) during the energy transition from 2015 to 2050.

An essential aspect in the transition of the transport sector towards higher electrification completely based on renewable energy is the production of synthetic fuels, hydrogen and sustainable biofuels. As indicated in Figure 3.4-17, the installed capacities of fuel conversion technologies increase substantially from 2040 onwards to over 1,100 GW by 2050. Water electrolysis forms the majority share

of fuel conversion capacities through the transition. Additionally, heat is needed during the production of synthetic fuels, mainly for energy-efficient CO₂ direct air capture, and this is enabled by managing process heat, which is otherwise not useable. Heat utilisation is in the range of 520 TWh_{th} by 2050, which is comprised of excess heat and recovered heat, as shown in Figure 3.4-17.

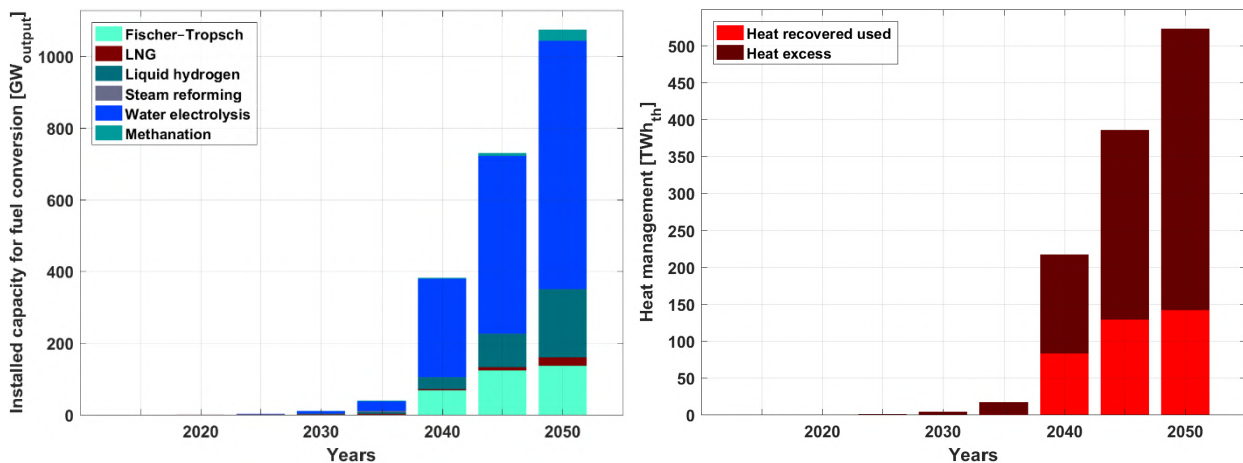

Figure 3.4-17: MENA – Transport sector installed capacity for fuel conversion (left) and heat management (right) during the energy transition from 2015 to 2050.

Similarly, gas storage is necessary in the production of synthetic fuels. As shown in Figure 3.4-18, the installed storage capacity for gas increases through the transition to around 10 TWh by 2050. Methane storage is the major gas stored through the transition, with a lower share for hydrogen storage in 2050. CO₂ storage and CO₂ direct air capture, which are vital in the production of synthetic fuels, are mainly installed from 2040 onwards. The

installed capacity for CO₂ storage and CO₂ direct air capture increases up to around 145 MtCO₂ by 2050, as shown in Figure 3.4-18. The major share of installed storage capacity is CO₂ direct air capture on an annual basis as compared to CO₂ storage. Despite having a lower storage capacity, CO₂ storage has a noticeable utilisation and correspondingly higher throughputs through the transition.

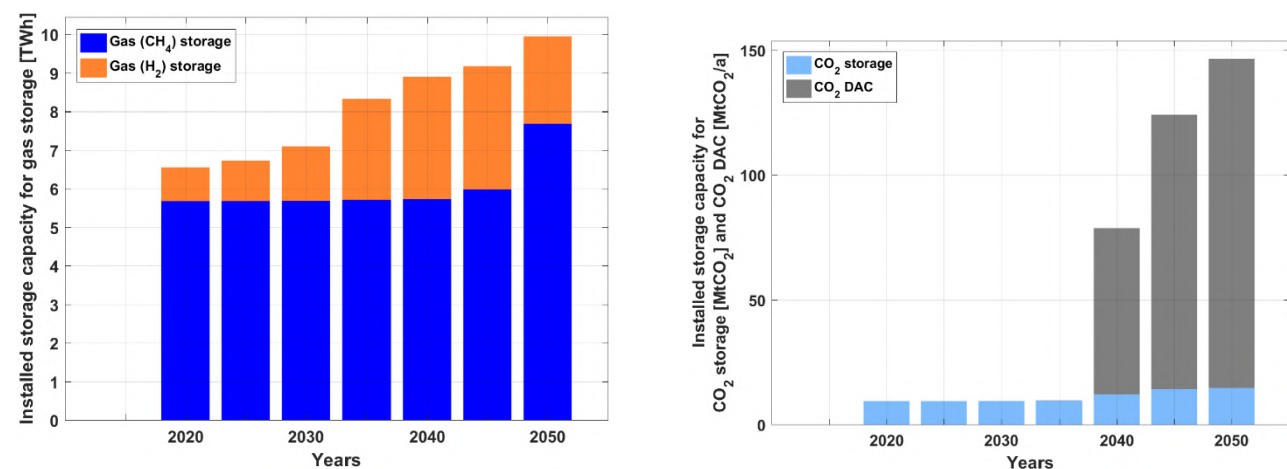

Figure 3.4-18: MENA – Transport sector installed capacity for gas (methane and hydrogen) storage (left) and CO₂ direct air capture and CO₂ storage (right) during the energy transition from 2015 to 2050.

Fuel costs are a deciding factor in the overall energy mix for the transport sector across MENA and their developing trends are highlighted in Figure 3.4-19. FT and SNG fuel costs decline through the transition up to 2050. Moreover, FT fuels are cost competitive with fossil liquid fuels including GHG emissions costs, at 90 €/MWh in 2050. In addition, SNG is more cost effective than LNG in 2050. Electricity emerges as the most cost effective option with LCOE primary around 19

€/MWh and along with complementary costs of storage and other system components, total LCOE is around 27 €/MWh in 2050. H₂ fuel costs decline to be more cost competitive than fossil fuels, in the range of 47 €/MWh in 2050, while liquid H₂ is in the range of 54 €/MWh. CO₂ from DAC is a critical component for synthetic fuels at around 32 €/tCO_{2eq} in 2050, using waste heat, as shown in Figure 3.4-19.

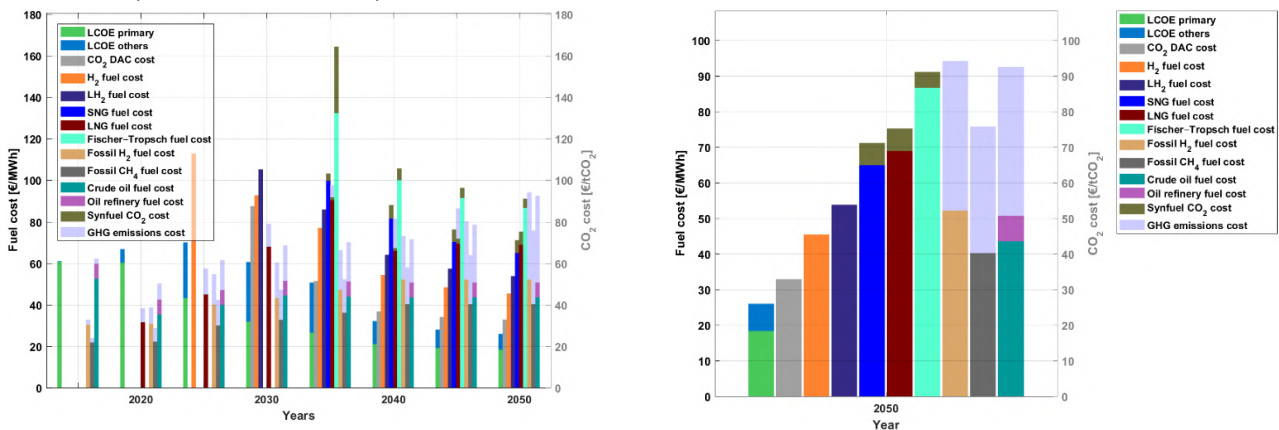

Figure 3.4-19: MENA – Fuel costs for the transport sector during the energy transition from 2015 to 2050 (left) and fuel costs in 2050 (right).

The final energy costs for transport are in the range of 100-140 b€ through the transition period with an increase from around 110 b€ in 2015 to about 130 b€ by 2050, as shown in Figure 3.4-20. Furthermore, annual system costs transit from being heavily dominated by fuel costs in 2015 to a very diverse share of costs across various technologies for electricity, synthetic fuels and sustainable biofuel production by 2050, as

highlighted in Figure 3.4-20. The difference in annual final transport energy and system costs is predominantly due to additional aspects of the system beyond 2040, as FT units produce naphtha as a by-product that adds to the overall system costs. The cost for naphtha is allocated to the industry sector as input for the chemical industry, since it is a valuable feedstock.

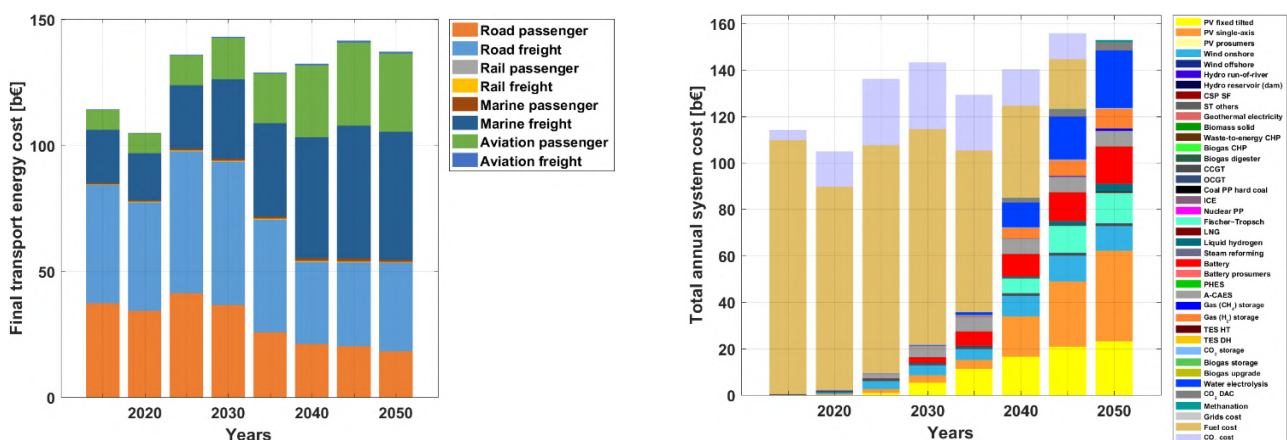

Figure 3.4-20: MENA – Final transport energy costs based on mode of transport (left) and source of energy (right) during the energy transition from 2015 to 2050.

The final transport passenger costs decline from around 0.1 €/p-km in 2015 to 0.055 €/p-km by 2050, as shown in Figure 3.4-21. Final transport passenger costs decline for road transport through the transition, whereas for marine and aviation there is a marginal increase from 2020 up to 2045 and again a slight decrease by 2050. Similarly, final

transport freight costs decline from around 0.12 €/t-km in 2015 to 0.03 €/t-km by 2050, as shown in Figure 3.4-21. The final freight costs in the case of road declines through the transition and slightly for rail, whereas it remains stable for aviation and marine.

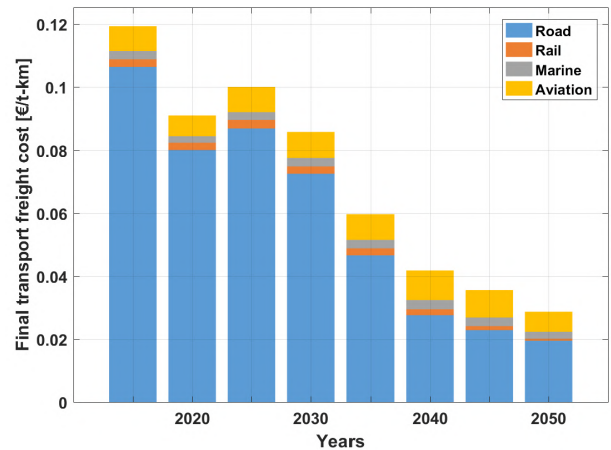
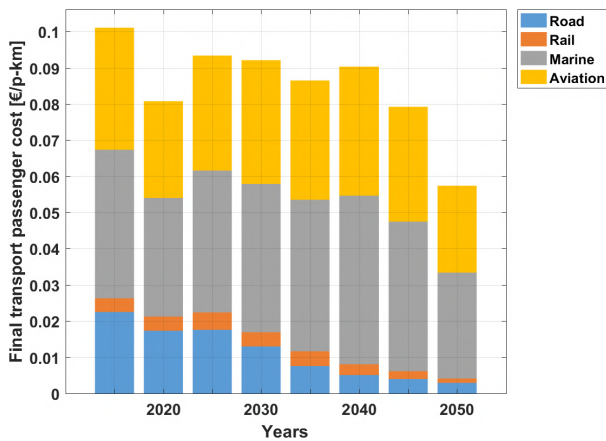

Figure 3.4-21: MENA – Final transport passenger cost (left) and final transport freight cost (right) during the energy transition from 2015 to 2050.

Desalination

The desalination demand in MENA is relatively larger compared to other regions of the world due to higher water stress and very limited replenishable groundwater resources, with substantial demand for desalinated water in the later part of the transition. Therefore, the installed capacities of power generation for the desalination

sector increases from around 10 GW in 2015 to over 600 GW by 2050 as shown in Figure 3.4-22. Solar PV and wind comprise the majority of installed capacities from 2030 until 2050. Primary electricity generation to meet the desalination demand in the initial period of the transition is from fossil gas up to 2030, beyond which PV and wind dominate as highlighted in Figure 3.4-22.

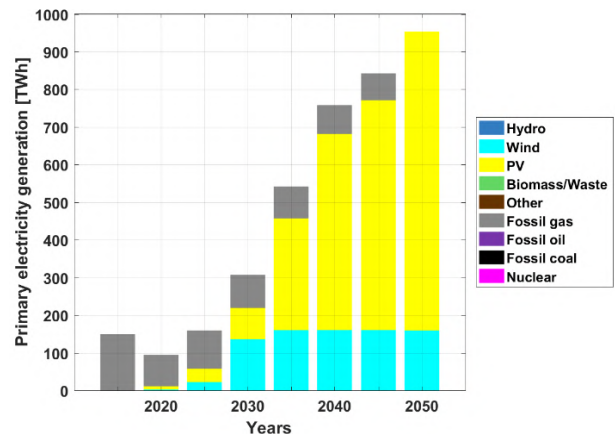
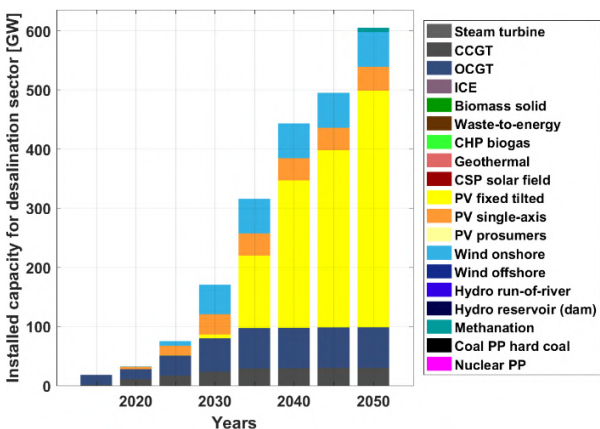

Figure 3.4-22: MENA – Technology-wise installed capacities for the desalination sector (left) and primary electricity generation for the desalination sector (right) during the energy transition from 2015 to 2050.

The installed storage capacity for desalination occurs mainly from 2035 onwards, with most of the capacities added in the final five-year period until 2050, as shown in Figure 3.4-23. Gas comprises more than 95% of the 29 TWh installed storage capacity in 2050, whereas batteries contribute the majority of the storage output, which reaches around 390 TWh_{el} by 2050 as shown in Figure 3.4-23.

Investments in power generation for the desalination sector occur mainly during 2030 to 2040, as shown in Figure 3.4-24. A majority of the investment is in wind, PV, and batteries, which reaches a high of around 110 b€ in 2035. The levelised cost of water declines through the transition from around 1.2 €/m³ in 2015 to around 0.9 €/m³ by 2050, as shown in Figure 3.4-24.

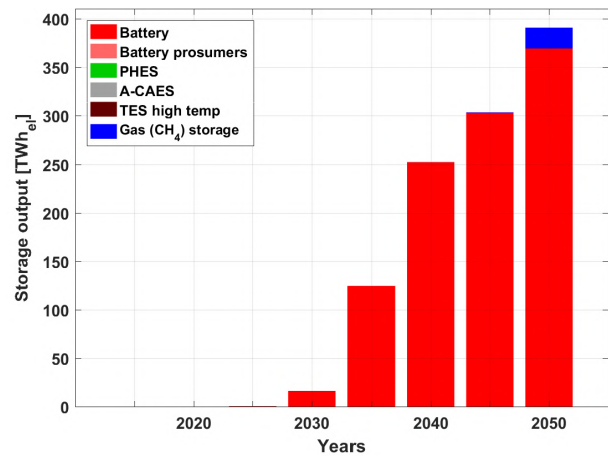
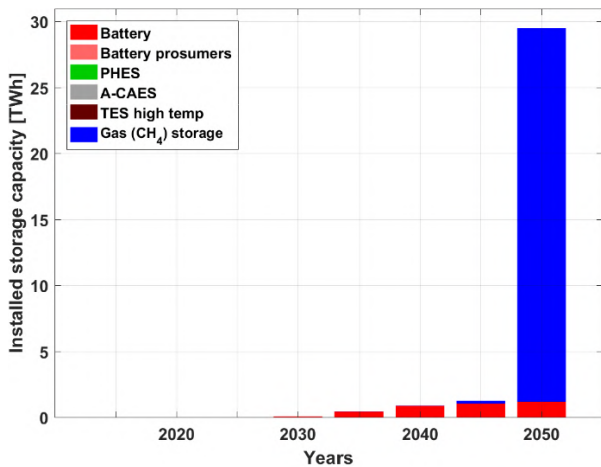

Figure 3.4-23: MENA – Installed storage capacity (left) and storage output (right) during the energy transition from 2015 to 2050.

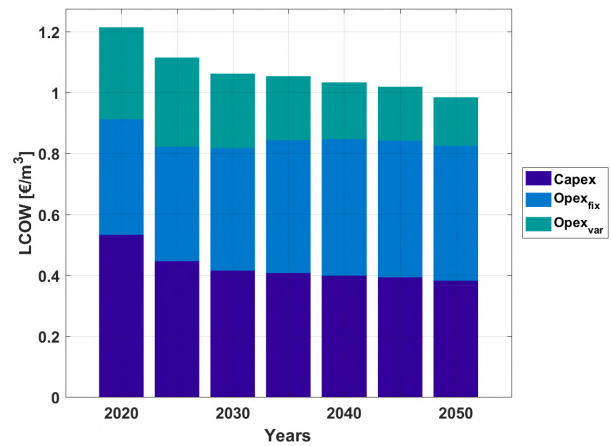
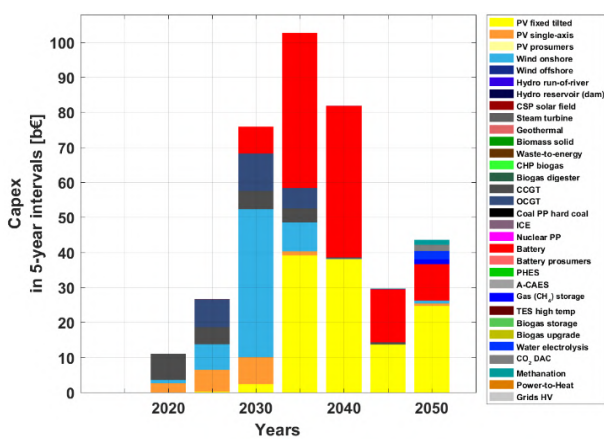

Figure 3.4-24: MENA – Capital costs for five-year intervals (left) and levelised cost of water (right) during the energy transition from 2015 to 2050.

Regional Outlook

Electricity generation capacities are installed across MENA to satisfy the demand for power, heat, transport, and desalination up to 2050. Solar PV capacities are predominant across all regions of MENA, which have excellent solar resources throughout the year, while wind energy capacities are mainly in the northern and western regions of MENA that have much better wind conditions, as

shown in Figure 3.4-25. Overall, solar PV and wind capacities along with some hydropower capacities constitute the majority of installed capacities in 2050 across MENA. Similarly, higher shares of solar PV generation are present across all the regions and higher shares of wind energy are mainly in the northern and western regions as highlighted in Figure 3.4-25.

Regional electricity capacities

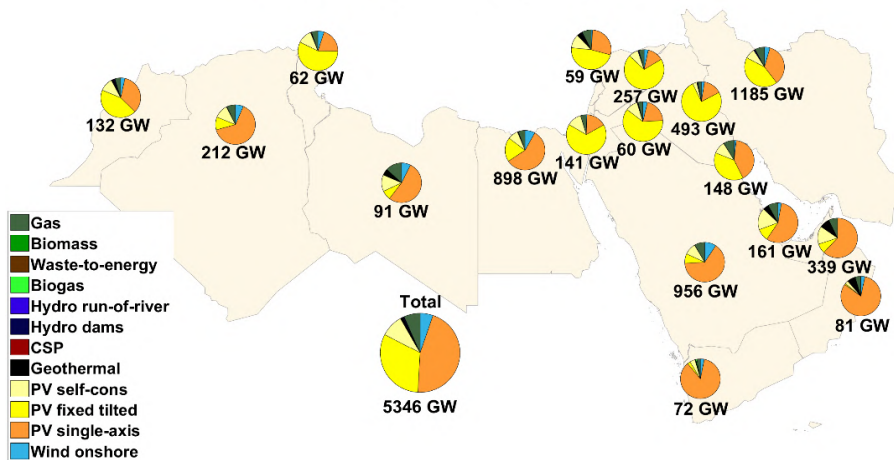

Regional electricity generation

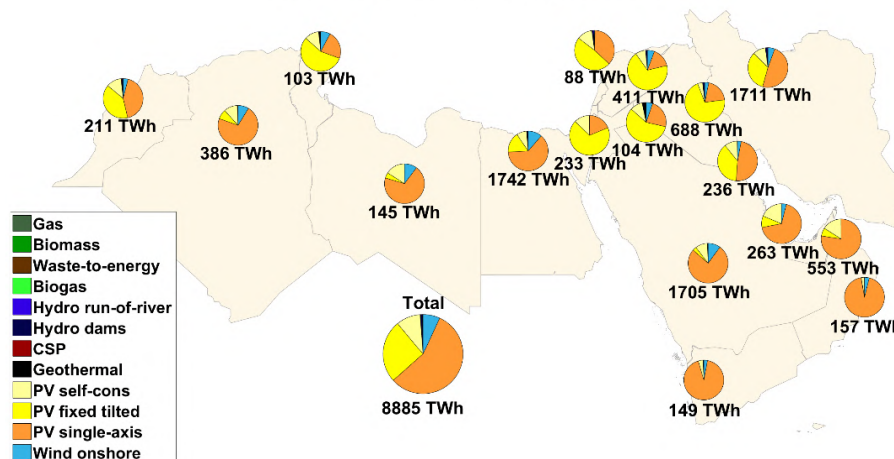

Figure 3.4-25: MENA – Regional electricity generation capacities (top) and electricity generation (bottom) in 2050.

Solar PV capacities are well distributed across the different regions of MENA and achieve a total installed capacity base of almost 4630 GW in 2050. Moreover, there are higher capacities mostly in the southern countries with good solar conditions throughout the year, as shown in Figure 3.4-26.

Whereas, wind energy capacities achieve a total installed capacity base of almost 280 GW in 2050 and are predominantly in the northern regions of Africa, which have some wind potential. This can be observed in Figure 3.4-26.

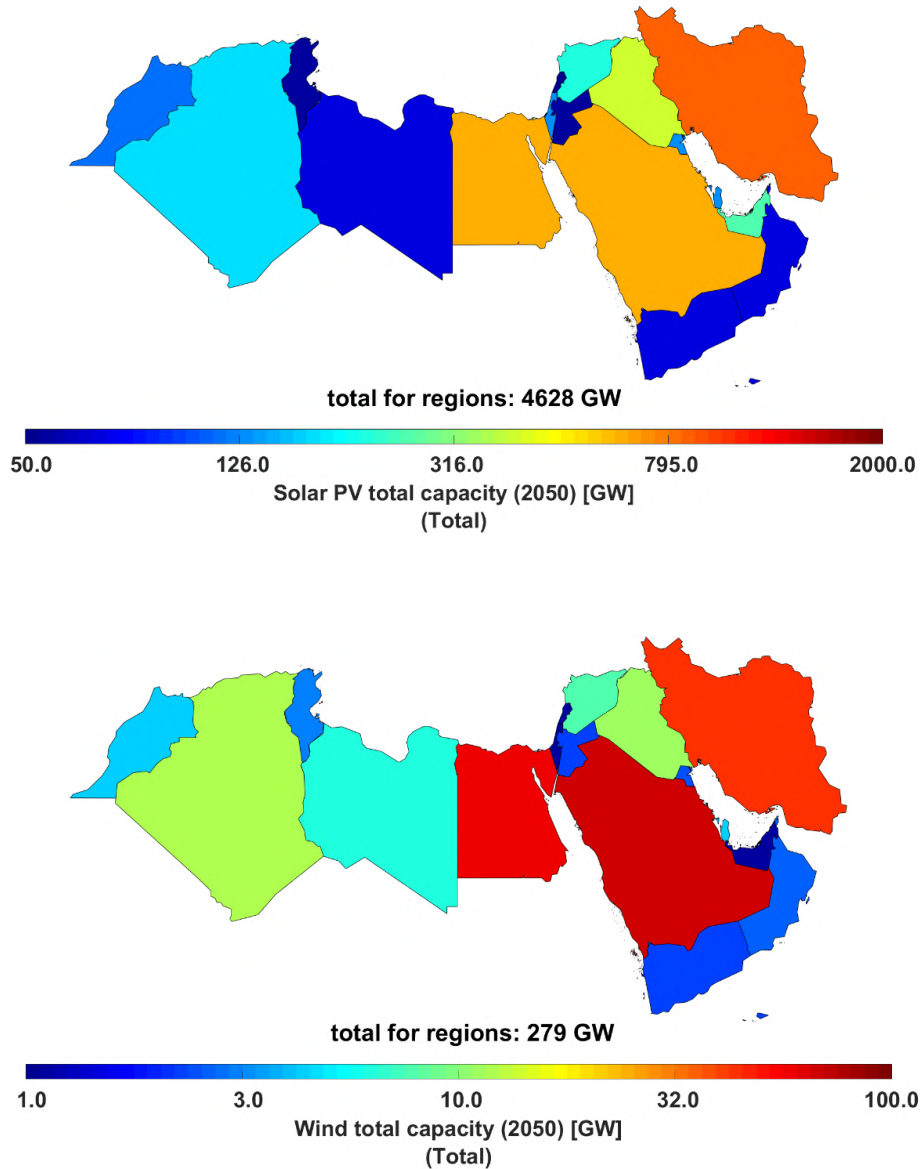

Figure 3.4-26: MENA – Regional variation of electricity generation capacities of solar PV (top) and wind energy (bottom) in 2050.

The electricity generation across the power, heat, transport, and desalination sectors of MENA are predominantly from PV and wind in 2050, which are well distributed across the region as shown in Figure 3.4-27. Solar PV, which supplies a regional average of 91.1% of electricity generation across MENA, is more common across all regions. While

wind energy, which contributes a regional average of 7.8% of electricity generation across MENA is mainly, found in the northern and western regions of MENA. Overall, solar PV and wind generate most of the electricity needed across MENA by 2050, which is around 98.9% of total electricity generation.

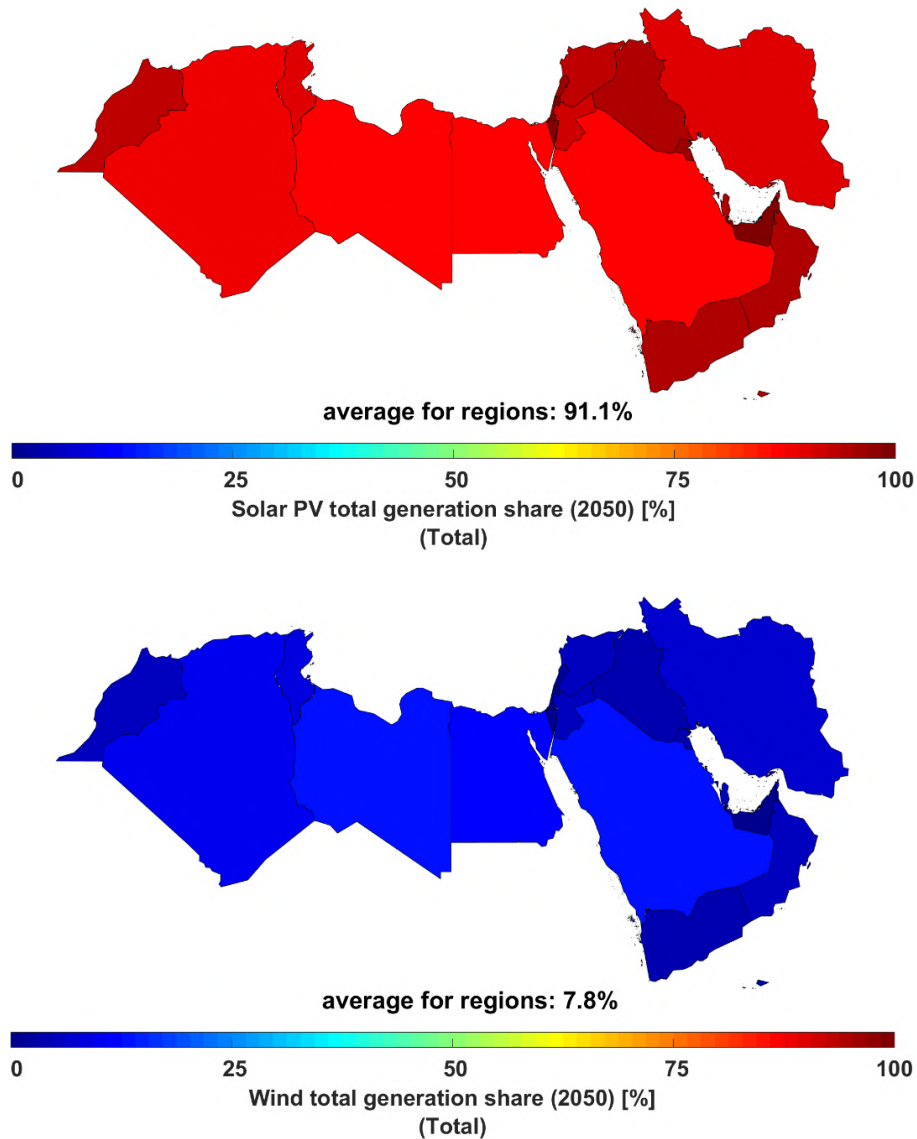
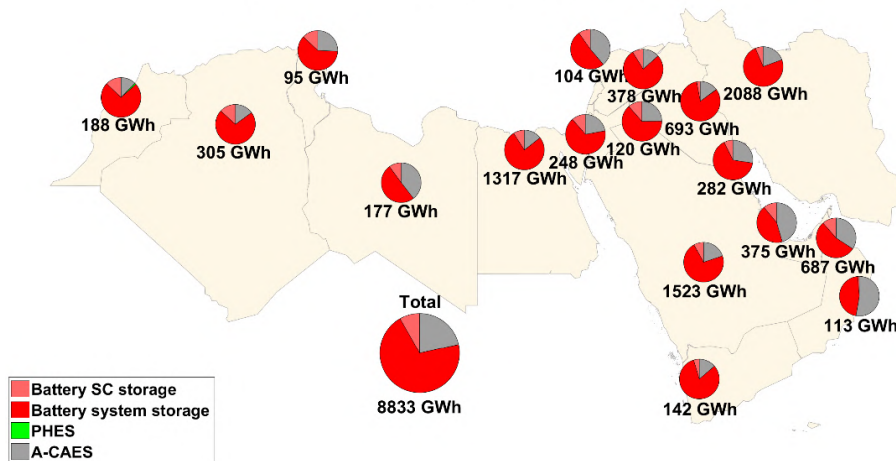

Figure 3.4-27: MENA – Regional variation of electricity generation shares of solar PV (top) and wind energy (bottom) in 2050.

Utility-scale and prosumer batteries contribute a major share of electricity storage capacities, with some shares of A-CAES by 2050, as shown in Figure 3.4-28. Storage capacities are evenly distributed across MENA, to complement the higher shares of installed solar PV capacities.

Batteries, both prosumers and utility-scale, deliver the largest shares of output by 2050, as shown in Figure 3.4.-28. A-CAES contributes complementary shares of electricity storage output through the transition, across the different regions of MENA.

Regional electricity storage capacities



Regional electricity storage annual generation

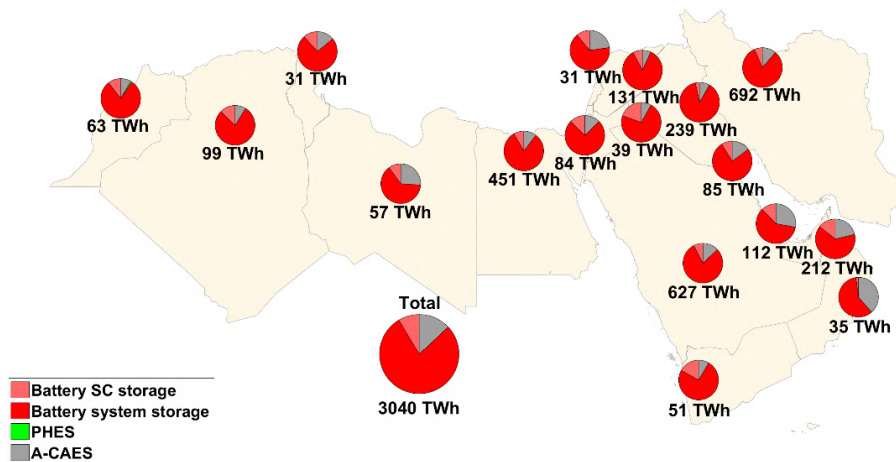

Figure 3.4-28: MENA – Regional electricity storage capacities (top) and electricity storage annual throughput (bottom) in 2050.

The storage output across the power, heat, transport, and desalination sectors of MENA is predominantly from batteries (both utility-scale and prosumers) and some synthetic natural gas supply in 2050, as shown in Figure 3.4-29. Batteries, which supply an average of 31.3% of the storage output across MENA, are more common across all the

regions. Synthetic natural gas, which supplies an average of 0.4% of the total electricity demand across MENA, is present evenly across all the regions of MENA. This is complemented with a supply share of storage from biomethane of less than 0.1% in 2050 across MENA.

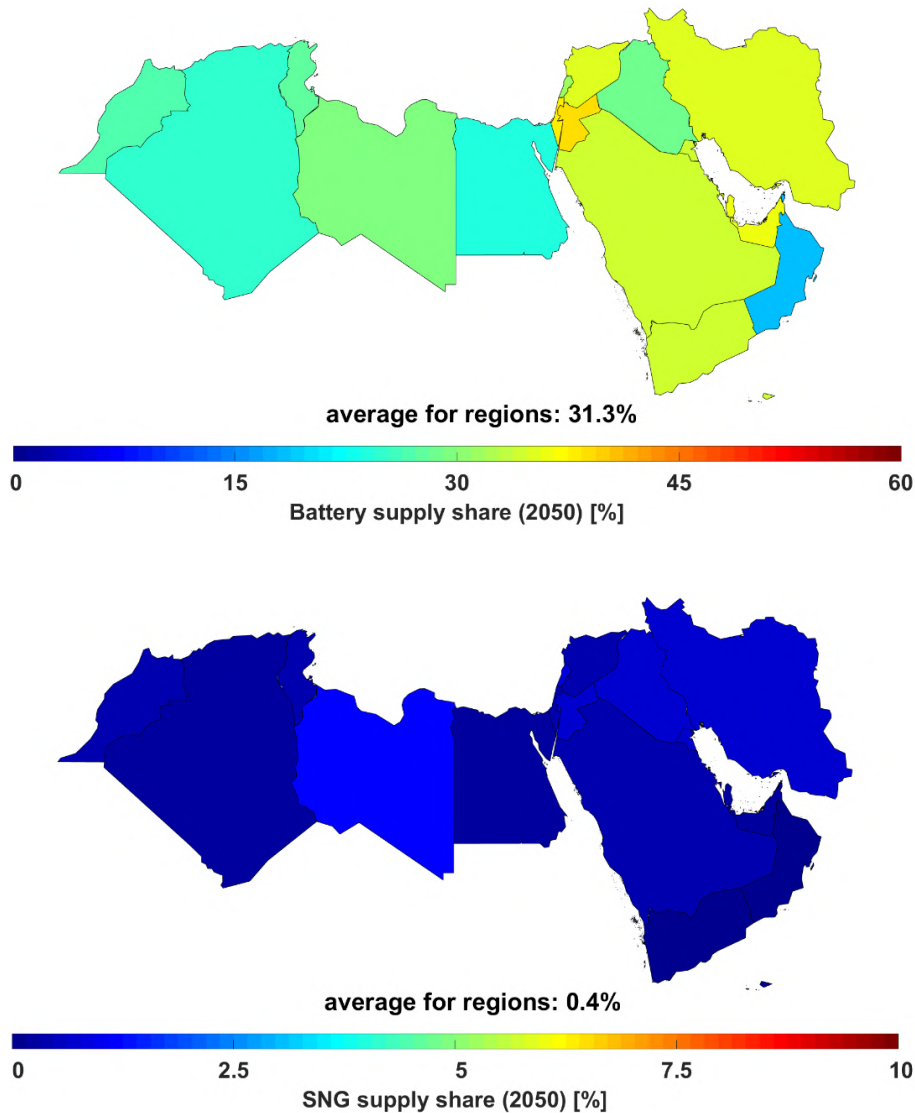
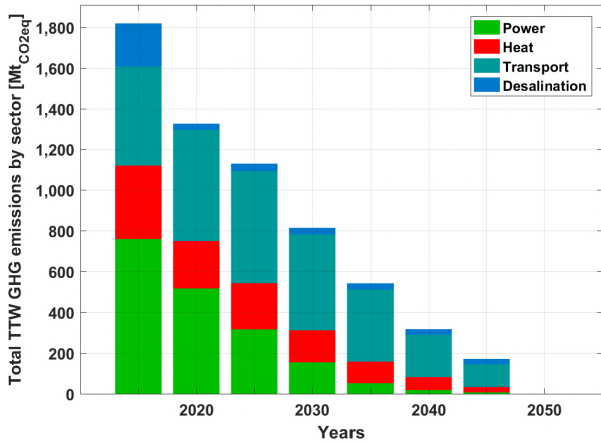

Figure 3.4-29: MENA – Regional variation of storage supply shares of batteries (top) and synthetic natural gas (bottom) in 2050.

Greenhouse Gas Emissions

The results of the energy transition towards a 100% renewable energy system indicate a sharp decline in GHG emissions until 2050, reaching zero GHG emissions by 2050 across the power, heat, transport, and desalination sectors in MENA as shown in Figure 3.4-30.



The power sector undergoes a deep decarbonisation by 2030, whereas for the heat and transport sectors this occurs mostly between 2030 and 2050.

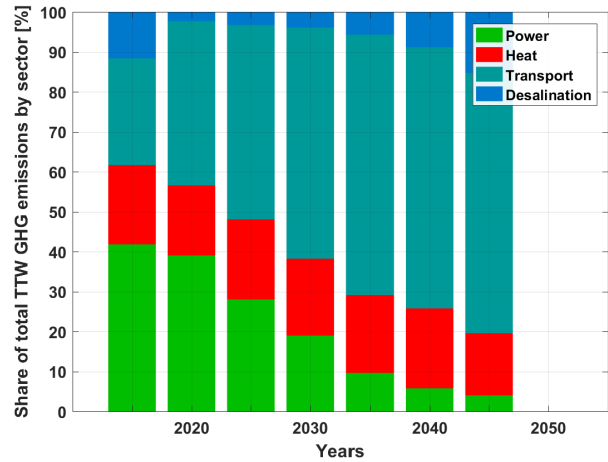

Figure 3.4-30: MENA – Sector-wise GHG emissions (left) and the share of GHG emissions of different sectors (right) during the energy transition from 2015 to 2050. Tank to Wheel (TTW) considers GHG emissions from readily available fuels and does not consider GHG emissions from the upstream production and delivery of fuels.

GHG emissions from the power sector decline through the transition from around 750 MtCO₂ eq./a in 2015 to zero by 2050 as shown in Figure 3.4-31. Similarly, GHG emissions from the heat sector decline through the transition from over 350 MtCO₂ eq./a in 2015 to zero by 2050 as shown in

Figure 3.4-31. Moreover, the remaining cumulative GHG emissions comprise around 22 GtCO_{2eq} from 2018 to 2050. Therefore, the energy transition pathway for MENA is in adherence to the ambitious Paris Agreement target of 1.5°C.

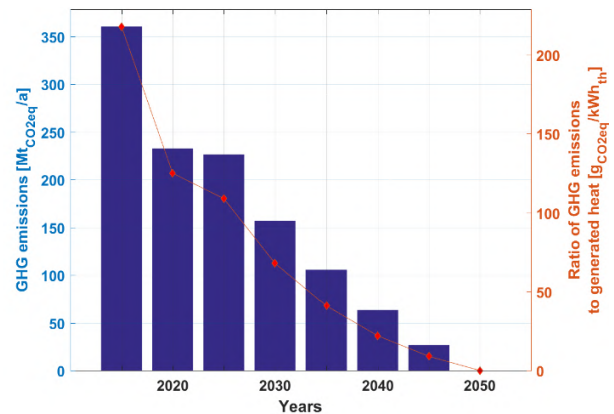
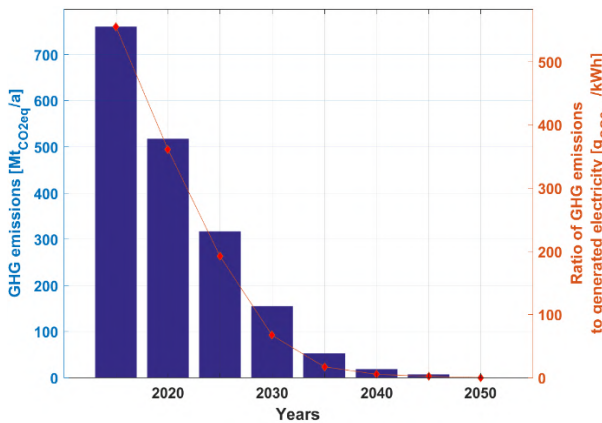

Figure 3.4-31: MENA – GHG emissions in the power sector (left) and GHG emissions in the heat sector (right) during the energy transition from 2015 to 2050.

GHG emissions from the transport sector after an initial increase, decline through the transition from around 550 MtCO₂ eq./a in 2020 to zero by 2050, as shown in Figure 3.4-32. Similarly, GHG emissions

from the desalination sector, which are much lower than those of other sectors, decline through the transition from over 35 MtCO₂ eq./a in 2025 to zero by 2050, also visible in Figure 3.4-32.

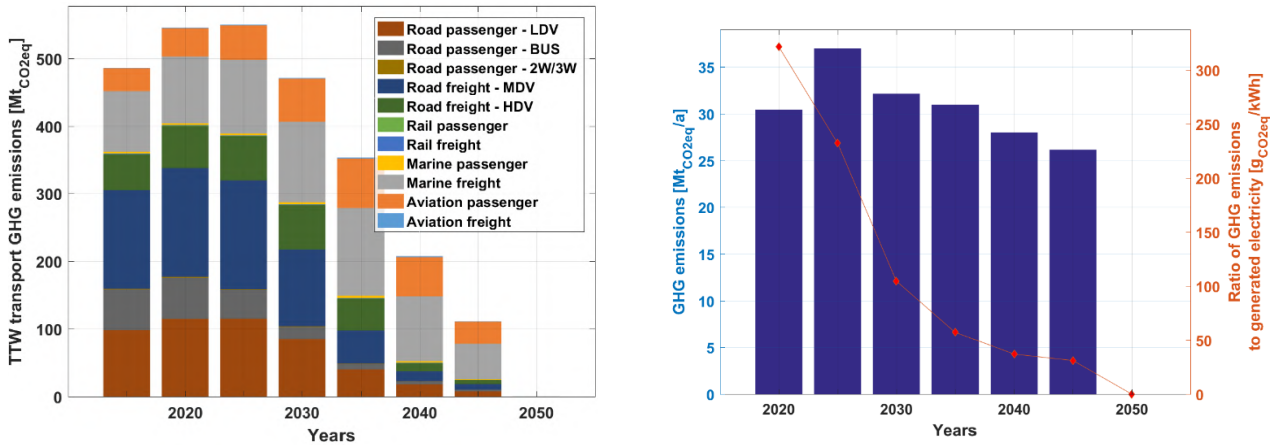

Figure 3.4-32: MENA – GHG emissions in the transport sector (left) and GHG emissions in the desalination sector (right) during the energy transition from 2015 to 2050. Tank to Wheel (TTW) considers GHG emissions from readily available fuels and does not consider GHG emissions from the upstream production and delivery of fuels.

Jobs in the Power Sector across MENA

Solar PV is the prime job creator through the transition period with almost a million jobs by 2050, as indicated in Figure 3.4-33. Wind power generation creates a fair share of jobs during the period of 2020 to 2030 (260 thousand jobs), beyond which the shares are reduced, as PV

becomes more cost competitive. Storage technologies in the form of batteries take off from 2030 onwards and lead to a decent share of jobs created up to 2050 (193 thousand jobs in the battery sector). The total number of direct energy jobs across the MENA region are observed to increase from just around 590 thousand in 2015 to nearly 1.7 million by 2050.

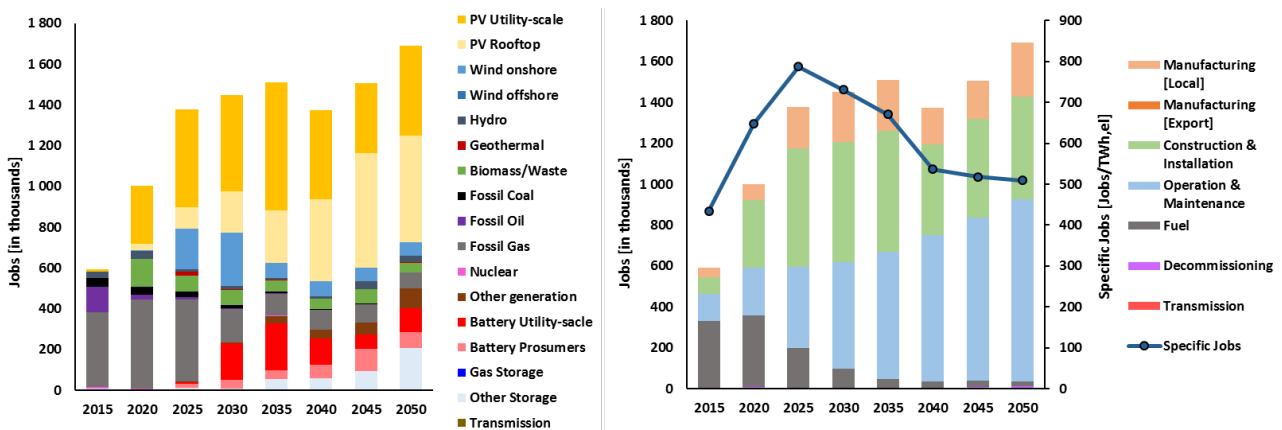

Figure 3.4-33: MENA – Jobs created by various power generation and storage technologies (left) and jobs created based on different categories with the development of electricity demand specific jobs (right) during the energy transition from 2015 to 2050.

Figure 3.4-33, also indicates the distribution of jobs across the different categories during the transition period in the MENA region. With rapid installation of capacities up to 2035, the majority of the jobs are created in the construction and installation of power generation technologies. Manufacturing jobs have a relatively low share in the initial periods up to 2020 as the share of imports is high. From 2025 onwards, as domestic production capabilities build up, a higher share of manufacturing jobs is observed until 2050 with 15% of total jobs. The share of fuel related jobs continues to diminish from 2020 onwards through the transition period reaching just 1% of total jobs by 2050, as

conventional power plants are replaced by renewable and storage technologies. By contrast, the share of operation and maintenance jobs grows through the transition period up to 53% of total jobs by 2050. This means more stable jobs for a region suffering from high unemployment amongst the youth and a growing number of economic migrants. The electricity demand specific jobs increases from 435 jobs/TWh_{el} in 2015 to 788 jobs/TWh_{el} in 2025 with the rapid ramp up in renewable energy installations. Beyond 2025, it declines steadily to around 509 jobs/TWh_{el} by 2050, as shown in Figure 3.4-33.

3.5. Sub-Saharan Africa

Sub-Saharan Africa is a region with a large number of emerging economies, with just around a 3% share in global GDP ⁶³, but has the potential to become one of the fastest growing regions in the world. Population in Sub-Saharan Africa is 989 million in 2015 representing a share of 14% in world population, which is estimated to be 23% in 2050. With a rapidly growing population, unprecedented economic progress and need for reliable, modern energy access, which is expected to require at least double the energy supply by 2030 and might even triple for electricity ⁶⁴. Africa's energy sector is vital to its development. Therefore, effective energy planning, optimal design, wise utilisation of all available renewable energy

resources and maximum synergy between various regions (regional electricity networking due to dispersed energy resources) of Africa will positively impact the energy systems across the continent. The detailed results for the energy transition across Sub-Saharan Africa are available in a supplementary data file, the link for the file can be found in the Appendix.

Penetration of renewables is not just a matter of replacing hydrocarbons with zero-carbon sources of energy supply – it also represents a significant change in resource efficiency. This is illustrated by the overall electrification across the power, heat, transport, and desalination sectors as shown in Figure 3.5-1.

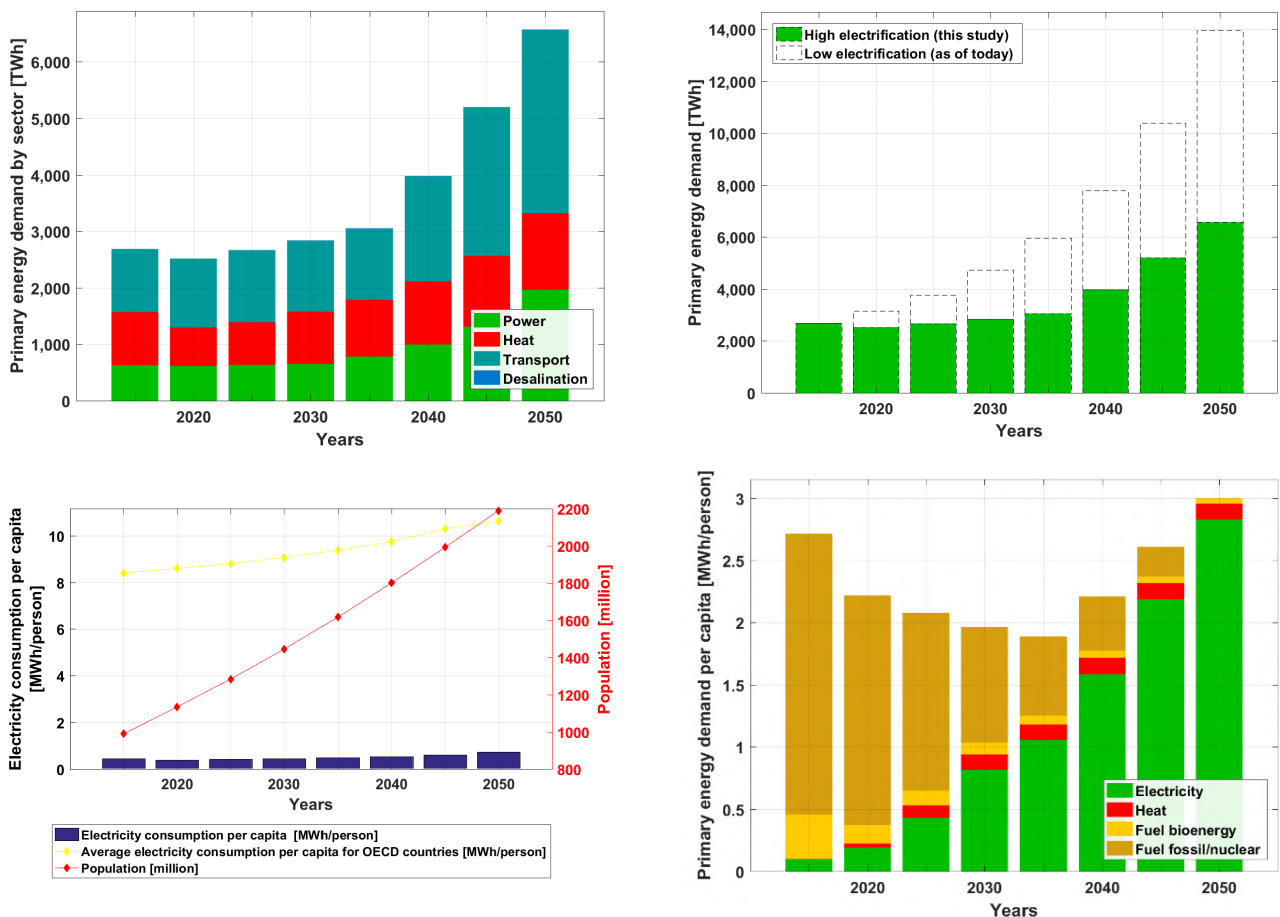

Figure 3.5-1: Sub-Saharan Africa – Primary energy demand sector-wise (top left), efficiency gain in primary energy demand (top right), electricity consumption per capita with population (bottom left) and primary energy demand per capita (bottom right) during the energy transition from 2015 to 2050.

The primary energy demand assuming high electrification, which is the basis for this study, increases from 2,700 TWh in 2015 to around 6,800 TWh by 2050 as shown in Figure 3.5-1. On the contrary, with low shares of electrification resulting from the adoption of current practices until 2050, the primary energy demand would reach nearly 14,000 TWh by 2050. The massive gain in energy efficiency is primarily due to a high level of electrification of more than 93% resulting in a reduction of around 7,200 TWh by 2050, in comparison to the continuation of current practices with low shares of electrification. The population across Sub-Saharan Africa is expected to grow massively from 989 to 2189 million by 2050. Correspondingly, the average per capita energy demand decreases from around 2.6 MWh/person in 2015 to 1.9 MWh/person by 2035 and increases up to nearly 3 MWh/person by 2050. The rapidly growing demand in the later part of the transition is primarily due to a substantial demand from fuel

conversion technologies arising beyond 2040, in producing renewable-based fuels for the transport sector across Sub-Saharan Africa.

Energy Supply

The electricity generation capacity across Sub-Saharan Africa satisfies demand from all energy sectors including power, heat, transport and desalination. The total installed capacity grows massively from around 100 GW in 2015 to around 3200 GW by 2050 as shown in Figure 3.5-2. In the initial period of the transition, some shares of wind capacities are installed up to 2030, but in the later part of the transition solar PV dominates the shares of installed capacities reaching almost 2920 GW by 2050. On the other hand, the shares of fossil fuels and nuclear decline through the transition to zero by 2050. Some shares of gas remain, but the fuel switches from fossil-based gas to synthetic natural gas produced with renewable electricity and biomethane.

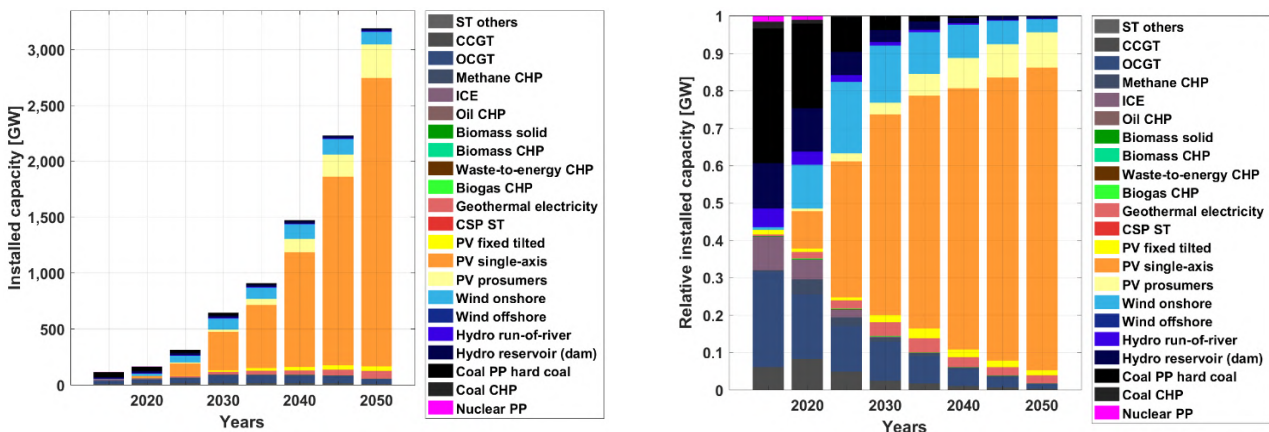

Figure 3.5-2: Sub-Saharan Africa – Technology-wise installed capacities (left) and technology-wise shares of installed capacities (right) during the energy transition from 2015 to 2050.

Electricity generation from the various technologies to cover the demand of power, heat, transport, and desalination sectors is shown in Figure 3.5-3. Solar PV supply increases through the transition from 51% in 2030 to about 87% by 2050, becoming the lowest cost energy source. Wind energy increases to 25% by 2030 and continues to decline in share of the mix up to 8% by 2050 as solar PV and batteries become more cost effective. In the heat

sector, heat pumps play a significant role through the transition with a share of nearly 43% of heat generation by 2050 on both the district and individual levels, as indicated in Figure 3.5-3. On the other hand, bio-based heating decreases through the transition from over 40% in 2015, to around 3% by 2050. Additionally, electric heating along with solar thermal and non-fossil gas based heating contribute through the transition.

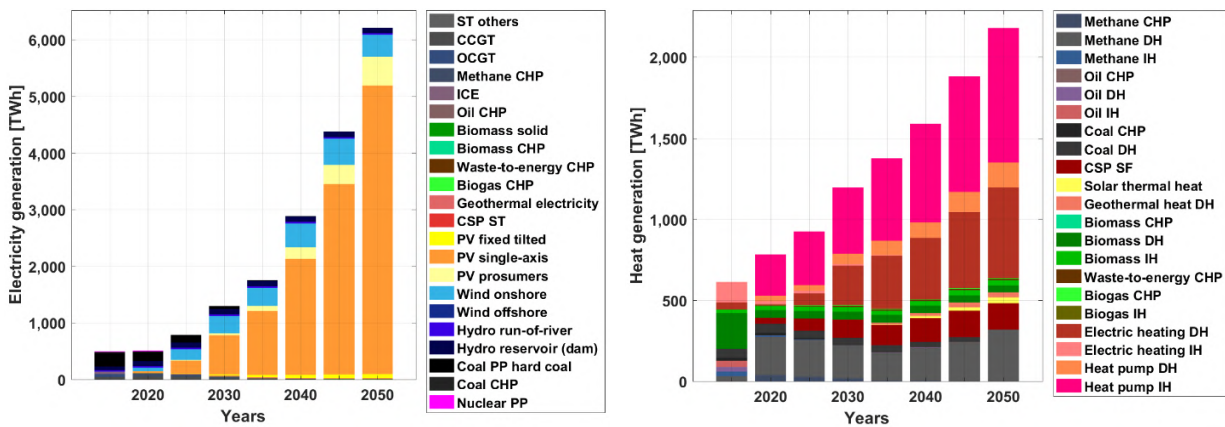

Figure 3.5-3: Sub-Saharan Africa – Technology-wise electricity generation (left) and technology-wise heat generation (right) during the energy transition from 2015 to 2050.

Energy Storage

Energy storage technologies play a critical role in enabling a secure energy supply throughout Sub-Saharan Africa, fully based on renewable energy across the different sectors. As highlighted in Figure 3.5-4, storage output covers around 1300 TWh_{el} of total electricity demand in 2050. The ratio of electricity demand covered by energy storage to electricity generation increases significantly to around 24% by 2030 and further on declines to

over 21% by 2050. This is primarily the result of better integration of the power and heat sectors that is complemented by the reduced demand for storage from the transport sector, as the production of synthetic fuels increase beyond 2040 onwards. An additional 5% is covered by heat storage conversion to electricity by 2050. Furthermore, batteries emerge as the most relevant electricity storage technology contributing about 85% of the total electricity storage output by 2050.

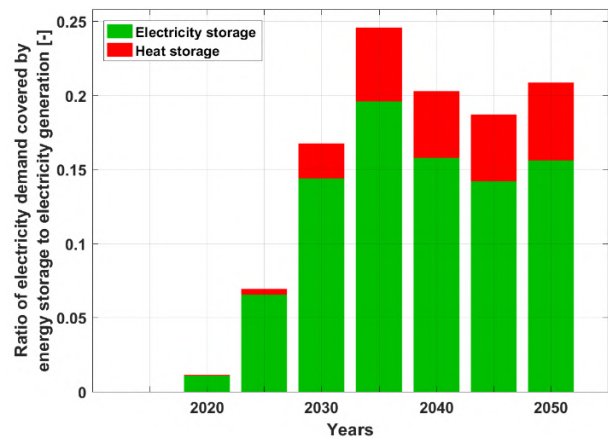
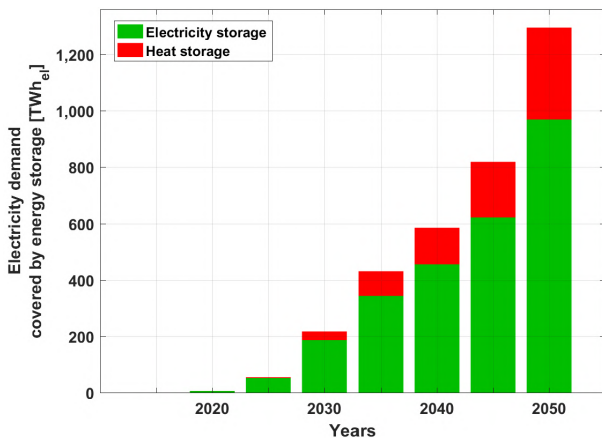

Figure 3.5-4: Sub-Saharan Africa – Electricity demand covered by energy storage (left) and ratio of electricity demand covered by different forms of energy storage (right) during the energy transition from 2015 to 2050.

Similarly, heat storage plays a vital role in ensuring heat demand is covered across all the sectors. As indicated in Figure 3.5-5, storage output covers more than 700 TWh_{th} of the total heat demand in 2050 and heat storage technologies are crucial to meet this demand. The ratio of heat demand covered by energy storage to heat generation increases substantially to over 26% by 2050, also shown in Figure 3.5-5. Thermal energy storage

(TES) emerges as the most relevant heat storage technology with around 57% of heat storage output from 2030 until 2050. Furthermore, power-to-gas (PtG) contributes around 43% of heat storage output in 2050. As fossil fuel usage for heat generation is completely eliminated in the final five-year period from 2045-2050, there is an increase in heat storage utilisation.

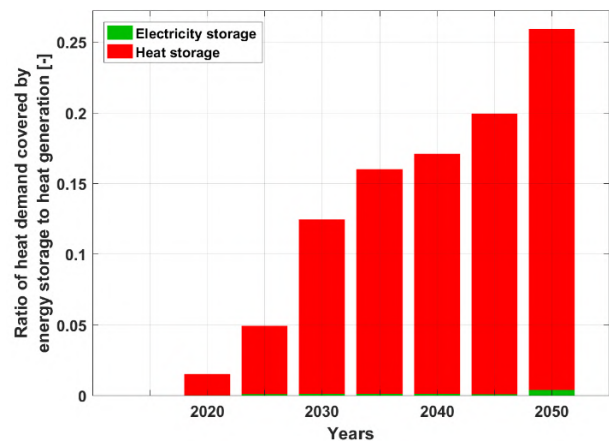
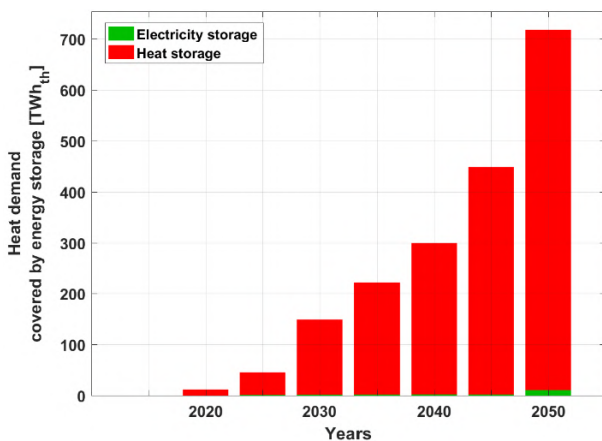

Figure 3.5-5: Sub-Saharan Africa – Heat demand covered by energy storage (left) and the ratio of heat demand covered by different forms of energy storage (right) during the energy transition from 2015 to 2050.

Costs and Investments

The total annual system costs are in the range of 110-270 b€ through the transition period and are well distributed across the major sectors of power, heat, and transport, as desalination demand in Sub-Saharan Africa is relatively smaller compared to other regions of the world. As indicated by Figure 3.5-6, power, heat, and transport costs increase from around 110b€ in 2020 to around 270 b€ in 2050, with increasing shares for heat and transport

through the transition. In addition, as indicated in Figure 3.5-5 CAPEX increases through the transition, as fuel costs decline. The steady increase in CAPEX-related energy system costs indicate that fossil fuel import and export dependent countries across Sub-Saharan Africa will fade out through the transition. In addition, a low fossil fuel import-export dependency will lead to higher levels of energy security and diversification across Sub-Saharan Africa.

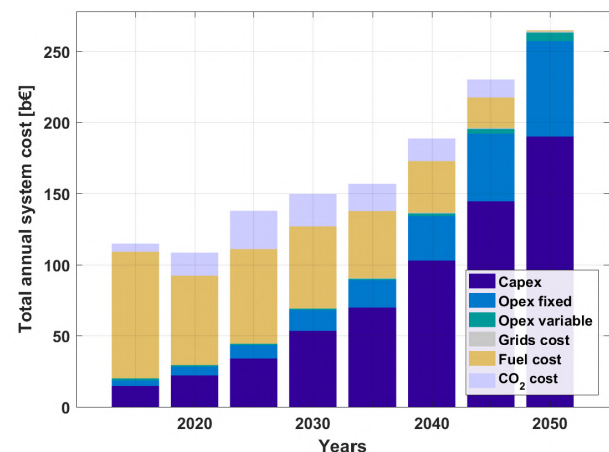
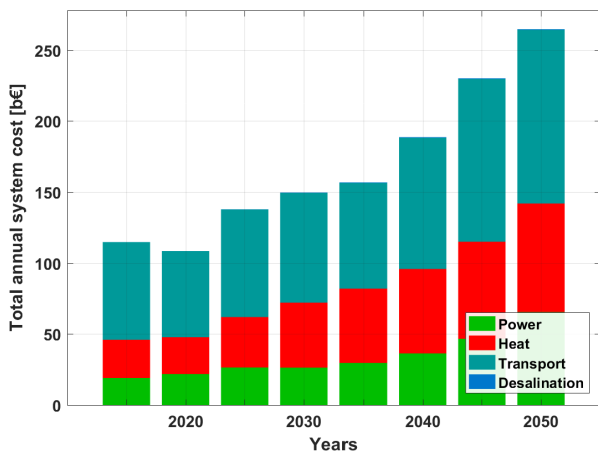

Figure 3.5-6: Sub-Saharan Africa – Annual system costs, sector-wise (left) and functionality-wise (right) during the energy transition from 2015 to 2050.

As increasing shares of power generation capacities are added globally, renewable energy sources become the least costing power generation sources⁶⁶. As indicated in Figure 3.5-7, levelised cost of energy declines from around 52 €/MWh in 2015 to 47 €/MWh by 2050 and is increasingly dominated by capital costs as fuel costs continue to decline through the transition period. This could mean increased levels of self-reliance in terms of

energy for the different countries across Sub-Saharan Africa by 2050, as mentioned earlier. Capital costs are well spread across a range of technologies with major investments for PV, wind energy, batteries, heat pumps, and synthetic fuel conversion technologies up to 2050, as shown in Figure 3.5-7. The cumulative investments are about 2,260 b€ through the transition from 2016-2050.

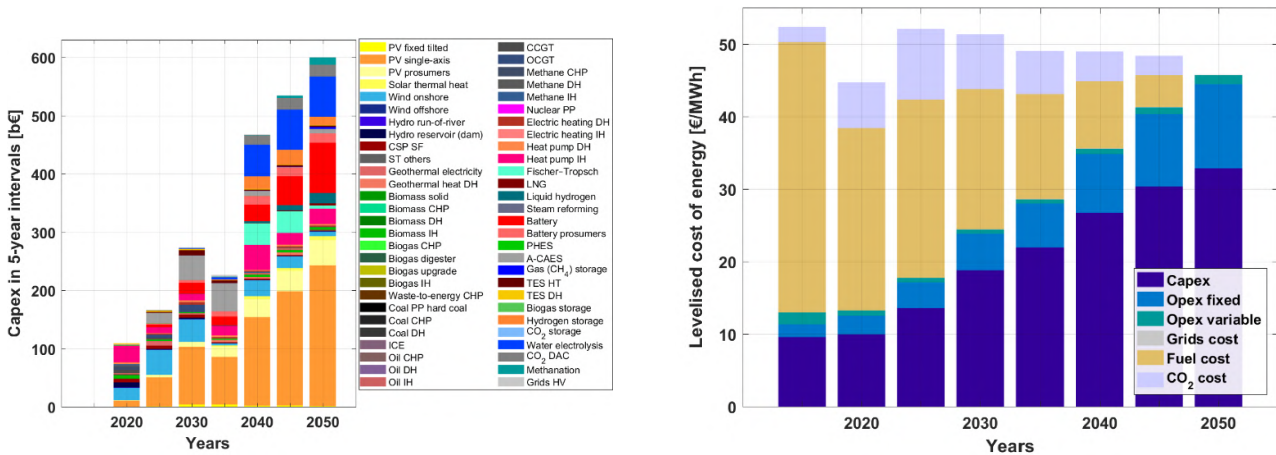

Figure 3.5-7: Sub-Saharan Africa – Capital costs for five-year intervals (left) and levelised cost of energy (right) during the energy transition from 2015 to 2050.

Outlook across sectors

Different trends in the power, heat, transport, and desalination sectors across Sub-Saharan Africa emerge through the transition. As the sectors transition towards having higher shares of renewable energy, different technologies have vital roles in ensuring the stability of the energy system. A closer look at the individual sectors provides further insights into the energy transition across Sub-Saharan Africa towards 100% renewable energy.

Power and heat

The total installed power generation capacities increases from just 100 GW in 2015 to over 1,500 GW by 2050, as shown in Figure 3.5-8. Across the power sector, solar PV with 1,340 GW, wind with 70 GW and hydropower with 27 GW constitute the majority of installed capacities by 2050. In the heat sector, heat pumps, electric heating, and biomass-based heating along with solar thermal heating constitute the majority of installed capacities by 2050, also shown in Figure 3.5-8.

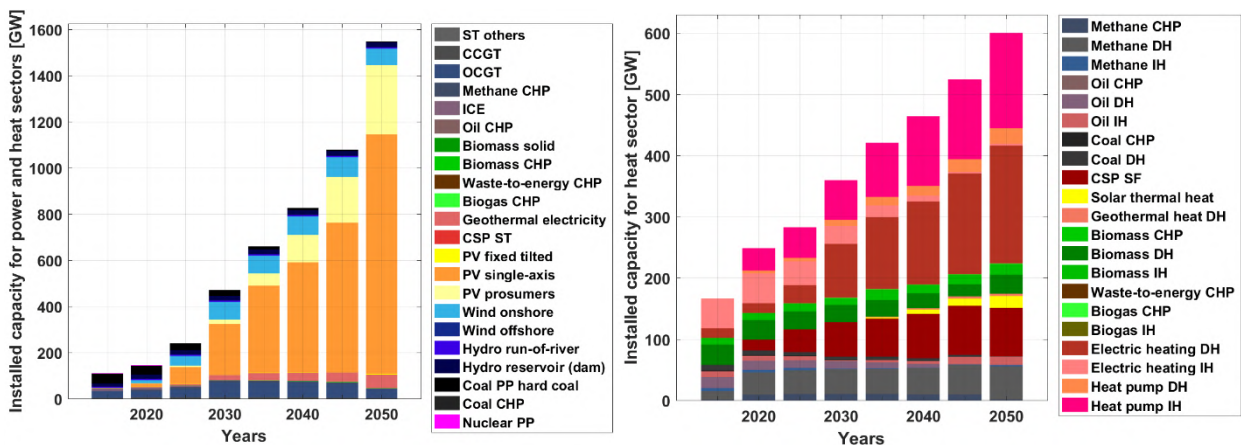

Figure 3.5-8: Sub-Saharan Africa – Technology-wise installed capacities for power (left) and heat (right) during the energy transition from 2015 to 2050.

The transition across Sub-Saharan Africa results in a power and heat sector dominated by fossil fuels in 2015 moving towards a solar PV, hydropower and wind energy dominated sector by 2050, as shown in Figure 3.5-9. The primary electricity generation increases from around 500 TWh in 2015 to almost 3,000 TWh by 2050, which is primarily from PV,

hydropower and wind energy. Similarly, heat generation increases from over 600 TWh in 2015 to around 2,300 TWh by 2050, which is predominantly from heat pumps and electric heating with some biomass-based heating, solar thermal and non-fossil gas based heating, also shown in Figure 3.5-9.

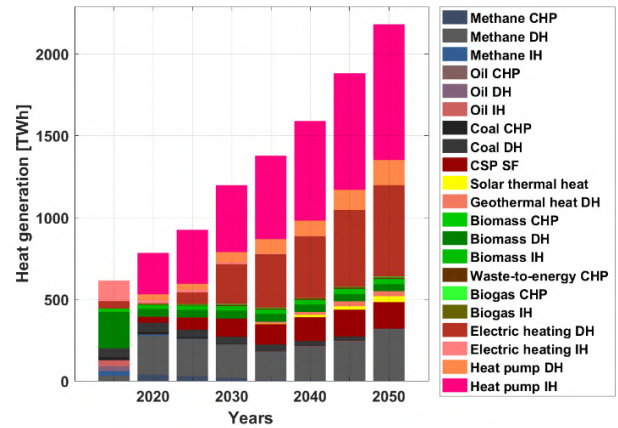
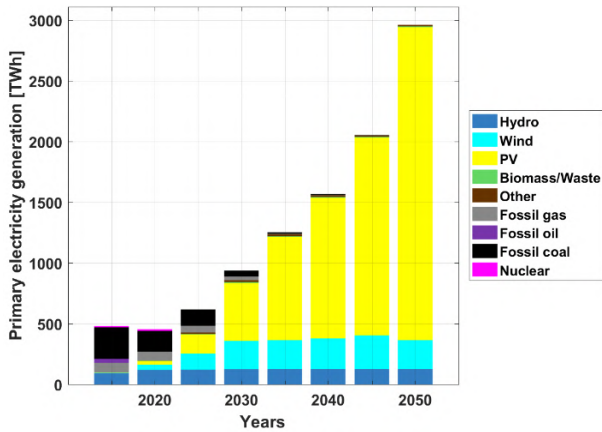

Figure 3.5-9: Sub-Saharan Africa – Primary electricity generation (left) and technology-wise heat generation (right) during the energy transition from 2015 to 2050.

The installed electricity storage capacity increases from just 0.03 TWh in 2015 to nearly 3 TWh by 2050, as shown in Figure 3.5-10. Utility-scale and prosumer batteries with some shares of A-CAES are installed through the transition. The installed capacities of A-CAES are also a consequence of the modelling approach, which prioritises full domestic energy supply for all regions across Sub-Saharan

Africa. The installed heat storage increases gradually until 2045 to around 5 TWh, but in the final five-year period up to 2050, a massive capacity of gas storage of nearly 27 TWh is added, as shown in Figure 3.5-10. This substantial capacity addition is mainly to provide seasonal storage across Sub-Saharan Africa covering the heat demand in the absence of fossil fuels.

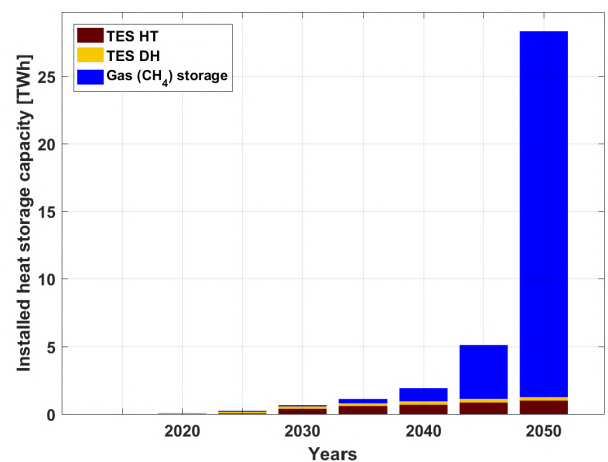
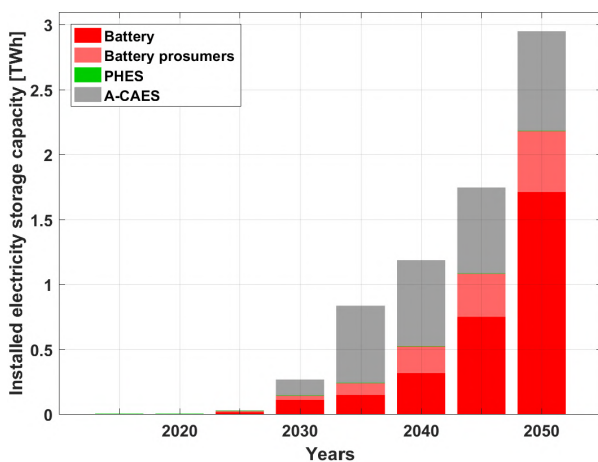

Figure 3.5-10: Sub-Saharan Africa – Installed electricity storage capacities (left) and heat storage capacities (right) during the energy transition from 2015 to 2050.

Utility-scale and prosumer batteries contribute a major share of electricity storage output with nearly 85% by 2050, as highlighted by Figure 3.5-11. In addition, A-CAES contributes through the transition. TES emerges as the most relevant heat storage technology through the transition, with

around 47% by 2050, also seen in Figure 3.5-11. Gas storage take prominence from 2040 onwards and contributes around 53% of the heat storage output in 2050 covering predominantly the seasonal demand, previously covered by fossil gas.

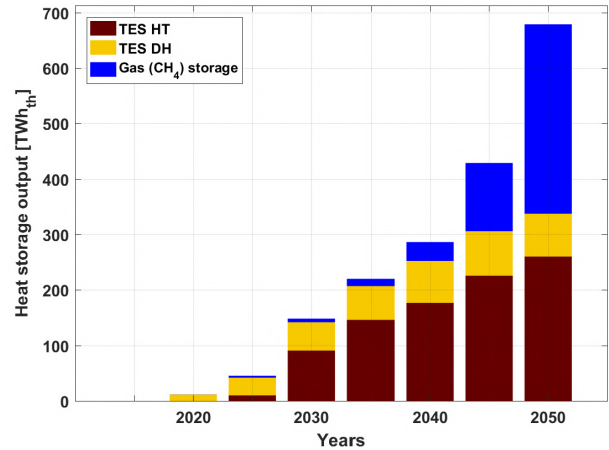
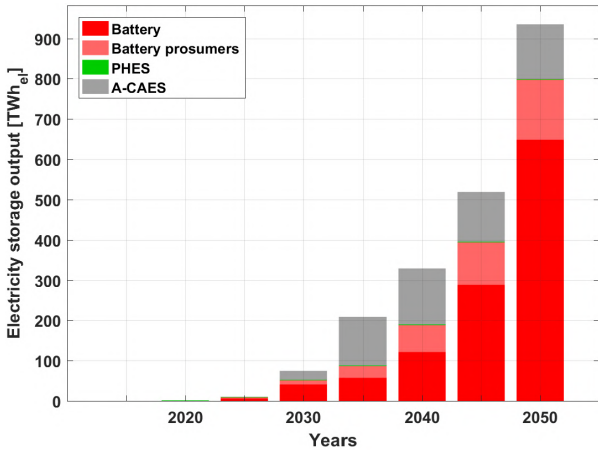

Figure 3.5-11: Sub-Saharan Africa – Electricity storage output (left) and heat storage output (right) during the energy transition from 2015 to 2050.

LCOE of the power sector decreases substantially from over 65 €/MWh in 2015 to around 43 €/MWh by 2050, as shown in Figure 3.5-12. LCOE is predominantly comprised of CAPEX as fuel costs decline through the transition. Whereas, LCOH of the heat sector increases marginally from around 33 €/MWh in 2015 to around 37 €/MWh by 2035

and further declines to around 34 €/MWh by 2050, as shown in Figure 3.5-12. Moreover, LCOH is predominantly comprised of CAPEX as fuel costs decline through the transition. Despite a substantial increase in heat demand across Sub-Saharan Africa, the LCOH remains quite stable through the transition up to 2050.

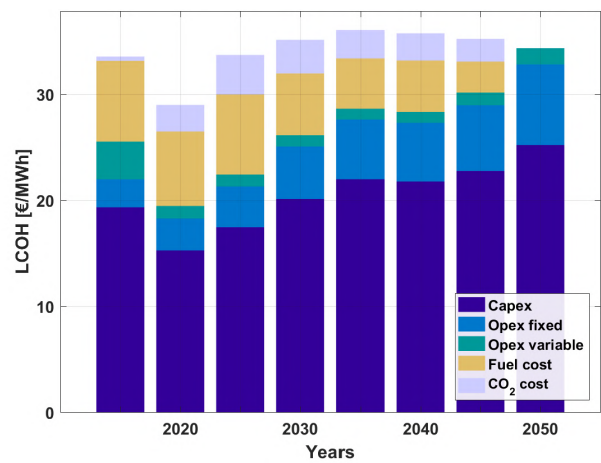
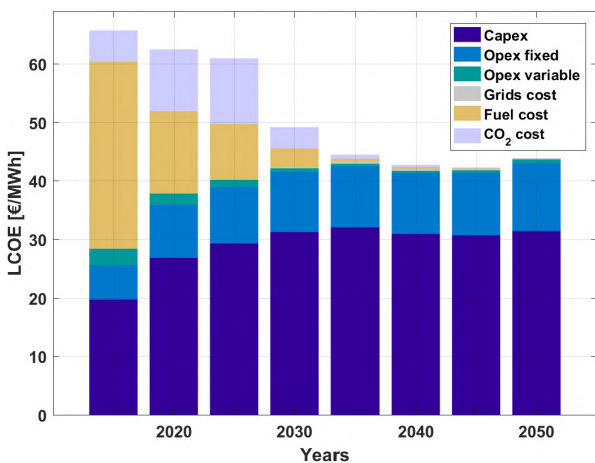

Figure 3.5-12: Sub-Saharan Africa – Levelised cost of electricity (left) and levelised cost of heat (right) during the energy transition from 2015 to 2050.

Investments are well spread across a range of power generation technologies with majority shares in wind energy and solar PV up to 2030, beyond which solar PV dominates investments up to 2050, as shown in Figure 3.5-13. Investments in the heat sector are mainly in heat pumps and some shares in

biomass and solar thermal heating up to 2050, also shown in Figure 3.5-13. The steep increase in heat pump investments in 2040 is mainly to cover the heat demand in the absence of fossil fuels as well as the lower costs of heat pumps in the later part of the transition.

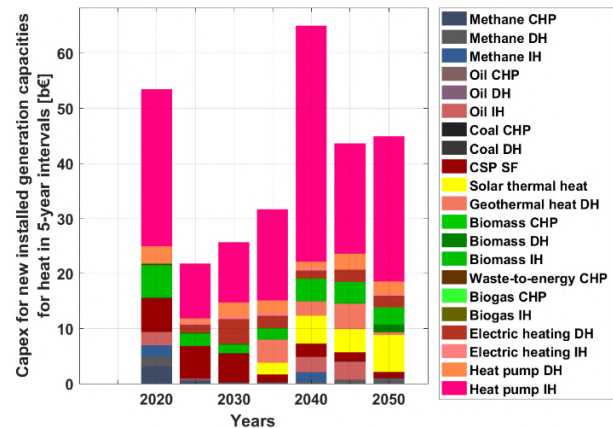
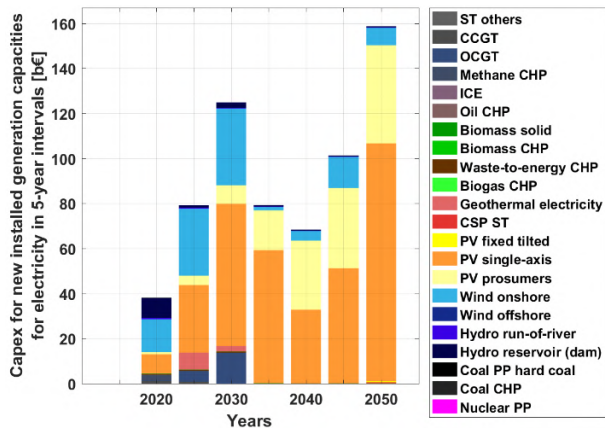

Figure 3.5-13: Sub-Saharan Africa – Capital costs of installed generation capacities in five-year intervals for electricity (left) and heat (right) during the energy transition from 2015 to 2050.

Transport

The primary energy demand of the transport sector across Sub-Saharan Africa is at around 1,100 TWh in 2015. However, this demand remains stable through the transition up to 2035, mainly due to the efficiency gains brought about by electrification of the sector as shown in Figure 3.5-14. Beyond that, it increases rapidly to around 1,900 TWh by 2050, mainly due to the production of synthetic fuels. On the contrary, fossil fuels consumption in the transport sector across Sub-Saharan Africa is seen to decline through the transition from about

99% in 2015 to zero by 2050. While, liquid fuels produced by renewable electricity contribute around 31% of final energy demand in 2050. In addition, hydrogen constitutes more than 29% of final energy demand in 2050. Sustainably produced biofuels contribute a minor share to enable a complete elimination of fossil fuel usage in the transport sector. Electrification of the transport sector creates an electricity demand of around 3,100 TWh_{el} by 2050. The massive demand for liquid fuels kicks in from 2040 onwards up until 2050, as indicated in Figure 3.5-14.

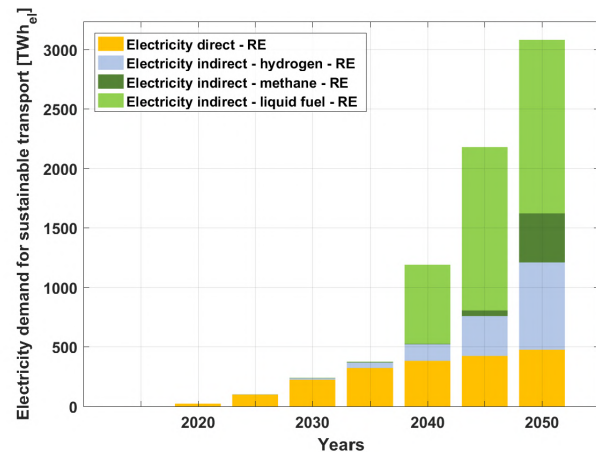
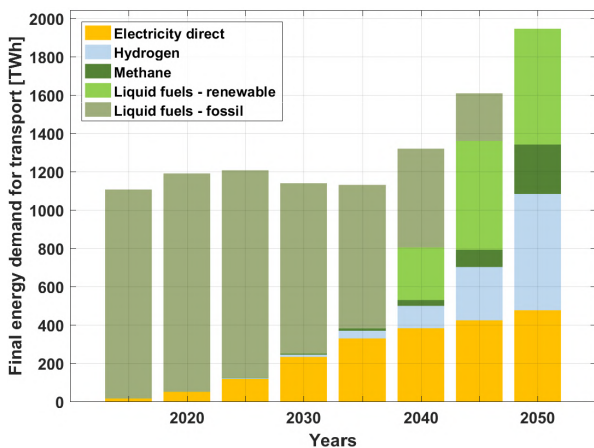

Figure 3.5-14: Sub-Saharan Africa – Final energy demand for transport (left) and electricity demand for sustainable transport (right) during the energy transition from 2015 to 2050.

Installed power generation capacity for the transport sector increases substantially through the transition to around 1,750 GW by 2050, as shown in Figure 3.5-15. Solar PV and wind form the majority shares of the power generation capacities for the transport sector, as they are the least

costing energy sources by 2050. Similarly, electricity generation increases substantially up to almost 3,300 TWh by 2050 also to be seen in Figure 3.5-15. Solar PV and wind energy generate all the electricity required to meet the demand of the transport sector in 2050.

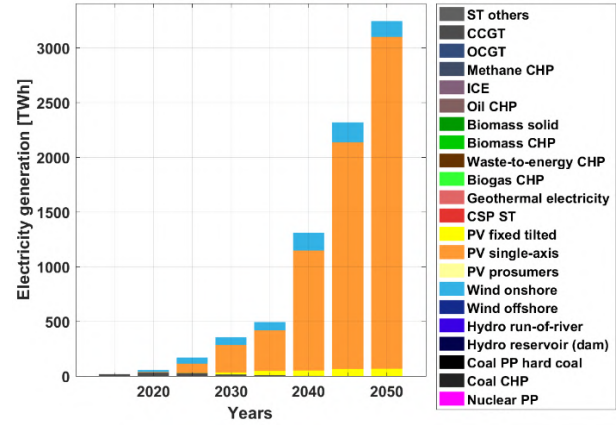
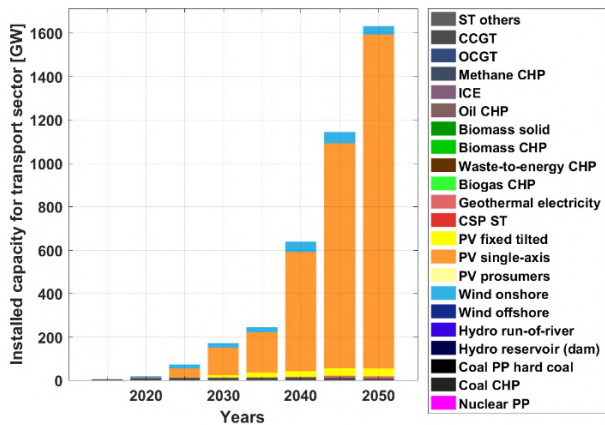

Figure 3.5-15: Sub-Saharan Africa – Transport sector installed power generation capacity (left) and electricity generation (right) during the energy transition from 2015 to 2050.

A critical aspect to complement the electrification of the transport sector is the installation of storage technologies. As seen in Figure 3.5-16, the installed capacities of electricity storage increase through the transition to around 1.2 TWh by 2050. The majority of installed capacities are A-CAES and utility-scale batteries. Similarly, electricity storage output increases through the transition to over 350 TWh_{el} by 2050 as shown in Figure 3.5-16. A-CAES

plays a vital role as it contributes a major portion of the output through the transition up to 2040, while utility-scale batteries contribute almost 64% in 2050. The relatively low electricity storage of around 10% of generated electricity for the transport sector is enabled by the flexible operation of batteries, water electrolyser units, and hydrogen buffer storage for synthetic fuel production.

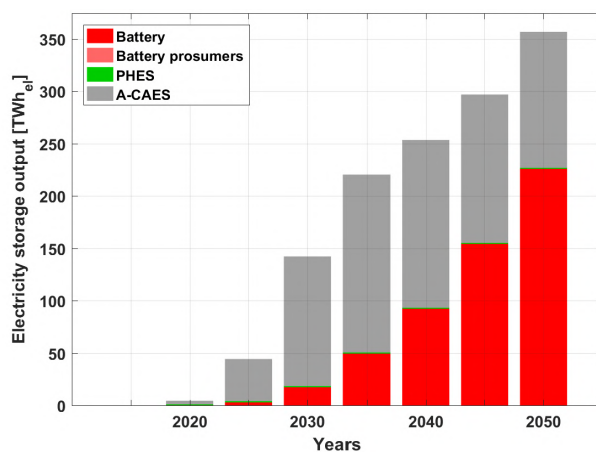
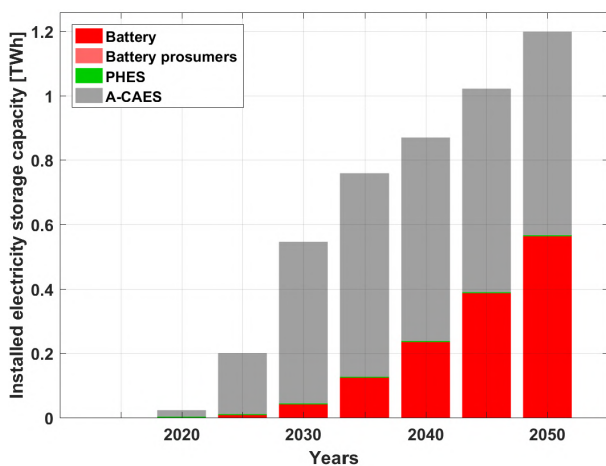

Figure 3.5-16: Sub-Saharan Africa – Transport sector installed electricity storage capacity (left) and electricity storage output (right) during the energy transition from 2015 to 2050.

An essential aspect in the transition of the transport sector towards higher electrification completely based on renewable energy is the production of synthetic fuels, hydrogen and sustainable biofuels. As indicated in Figure 3.5-17, the installed capacities of fuel conversion technologies increase substantially from 2040 onwards to over 1,000 GW by 2050. Water electrolysis forms the majority share

of fuel conversion capacities through the transition. Additionally, heat is needed during the production of synthetic fuels, mainly for energy-efficient CO₂ direct air capture, and this is enabled by managing process heat, which is otherwise not useable. Heat utilisation is in the range of 500 TWh_{th} by 2050, which is comprised of excess heat and recovered heat, as shown in Figure 3.5-17.

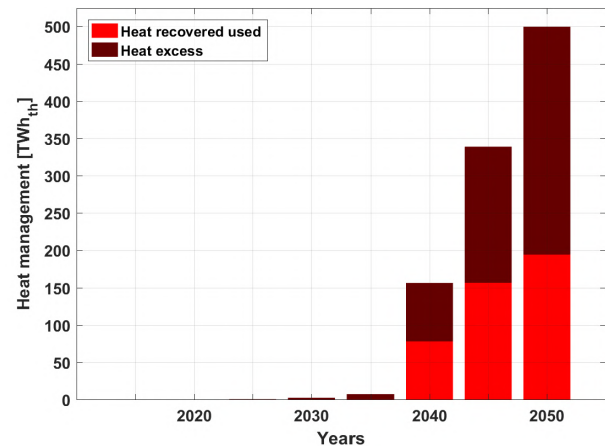
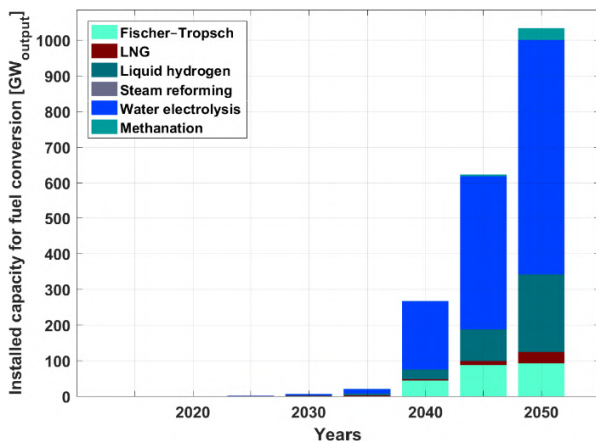

Figure 3.5-17: Sub-Saharan Africa – Transport sector installed capacity for fuel conversion (left) and heat management (right) during the energy transition from 2015 to 2050.

Similarly, gas storage is necessary in the production of synthetic fuels. As shown in Figure 3.5-18, the installed storage capacity for gas increases through the transition to around 3.7 TWh by 2050. Hydrogen storage is the major gas stored through the transition, with a minor share for methane gas in 2050. CO₂ storage and CO₂ direct air capture, which are vital in the production of synthetic fuels, are installed from 2040 onwards. The installed

capacity for CO₂ storage and CO₂ direct air capture increases to over 180 MtCO₂ by 2050, as shown in Figure 3.5-18. The major share of installed storage capacity is CO₂ direct air capture on an annual basis, as compared to CO₂ storage, which is minor shares. Despite having a lower storage capacity, CO₂ storage has a substantial utilisation and correspondingly higher throughput.

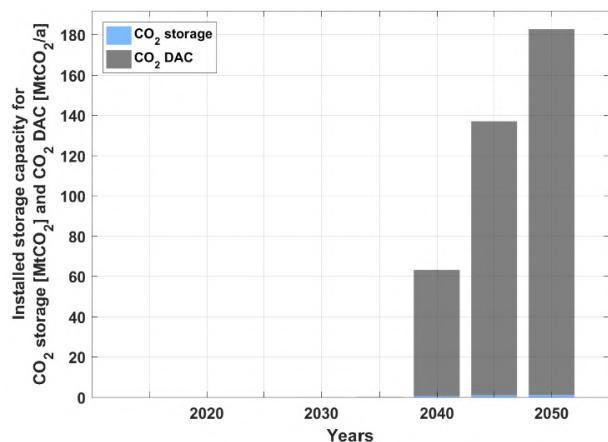
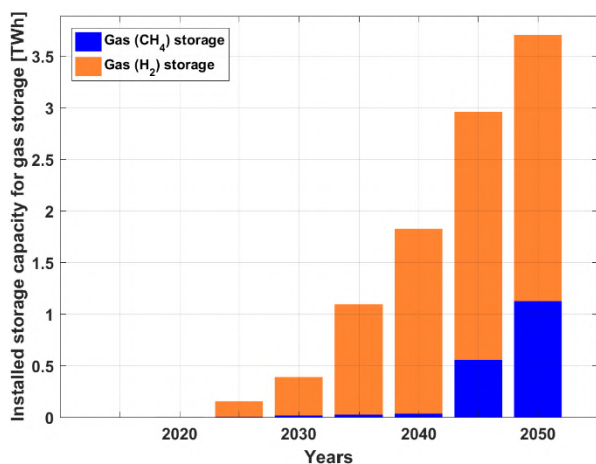

Figure 3.5-18: Sub-Saharan Africa – Transport sector installed capacity for gas (methane and hydrogen) storage (left) and CO₂ direct air capture and CO₂ storage (right) during the energy transition from 2015 to 2050.

Fuel costs are a deciding factor in the overall energy mix for the transport sector across Sub-Saharan Africa and their developing trends are highlighted in Figure 3.5-19. FT and SNG fuel costs decline through the transition up to 2050 and FT fuels are cost competitive with fossil liquid fuels including GHG emissions costs at 85 €/MWh in 2050. In addition, SNG is more cost effective than LNG in 2050. Electricity emerges as the most cost effective option with LCOE primary around 15

€/MWh and along with complementary costs of storage and other system components, total LCOE is around 22 €/MWh in 2050. H₂ fuel costs decline to be more cost competitive than fossil fuels, in the range of 40 €/MWh in 2050, while liquid H₂ is in the range of 50 €/MWh. CO₂ from DAC is a critical component for synthetic fuels at around 31 €/tCO_{2eq} in 2050, using waste heat, as shown in Figure 3.5-19.

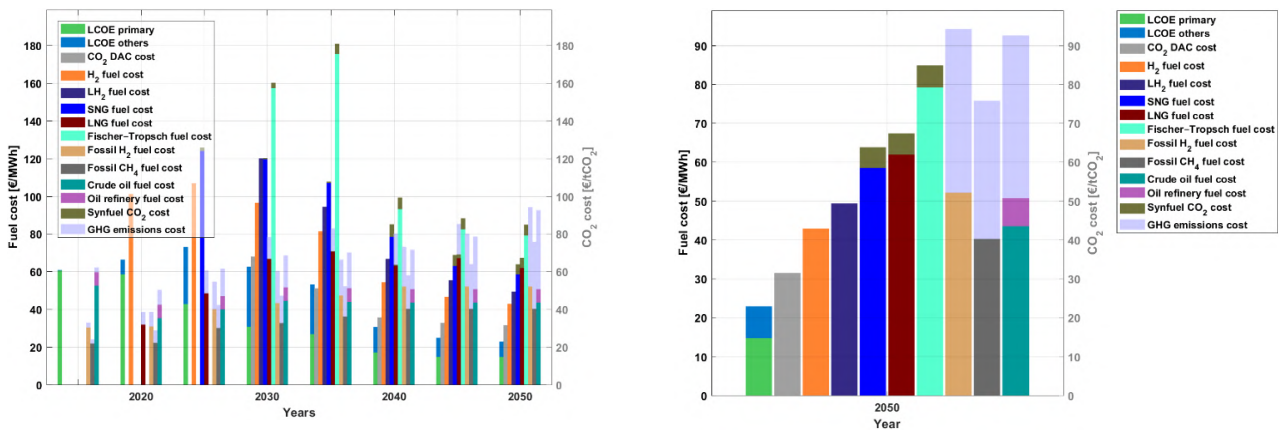

Figure 3.5-19: Sub-Saharan Africa – Fuel costs for the transport sector during the energy transition from 2015 to 2050 (left) and fuel costs in 2050 (right).

The final energy costs for transport are in the range of 60-110 b€ through the transition period with a steady increase until 2050, as shown in Figure 3.5-19. Furthermore, annual system costs transition from being heavily dominated by fuel costs in 2015 to a very diverse share of costs across various technologies for electricity, synthetic fuels and sustainable biofuel production by 2050, as

highlighted in Figure 3.5-20. The difference in annual final transport energy and system costs is predominantly due to additional aspects of the system beyond 2040, as FT units produce naphtha as a by-product, that adds to the overall system costs. The cost for naphtha is allocated to the industry sector as input for the chemical industry, since it is a valuable feedstock.

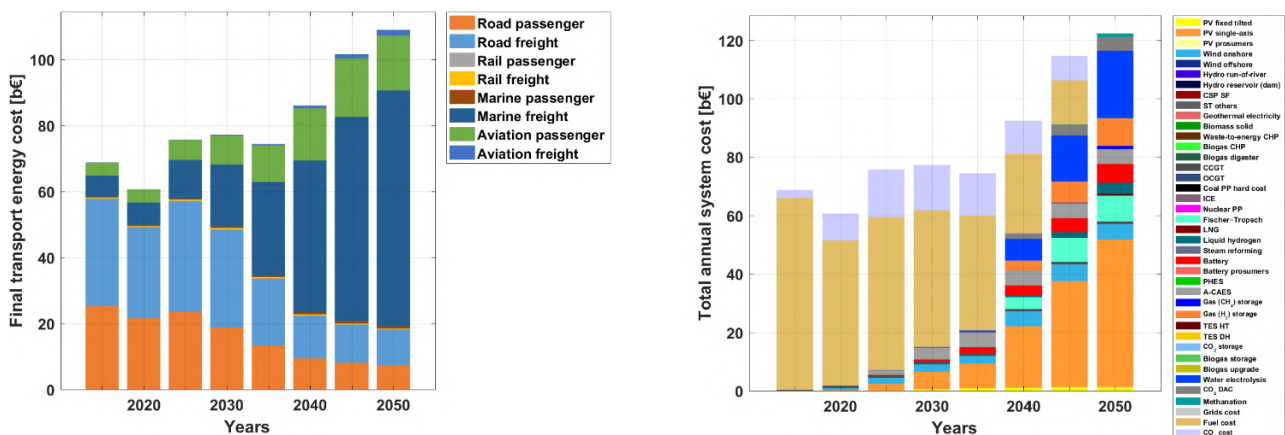

Figure 3.5-20: Sub-Saharan Africa – Final transport energy costs based on mode of transport (left) and source of energy (right) during the energy transition from 2015 to 2050.

The final transport passenger costs decline from nearly 0.10 €/p-km in 2015 to around 0.06 €/p-km by 2050, as shown in Figure 3.5-21. Final transport passenger costs decline for road transport through the transition, whereas for marine and aviation there is a marginal decrease. Similarly, final

transport freight costs decline from around 0.10 €/t-km in 2015 to over 0.02 €/t-km by 2050, as shown in Figure 3.5-21. The final freight costs in the case of road decline through the transition, whereas remaining stable for rail, aviation and marine.

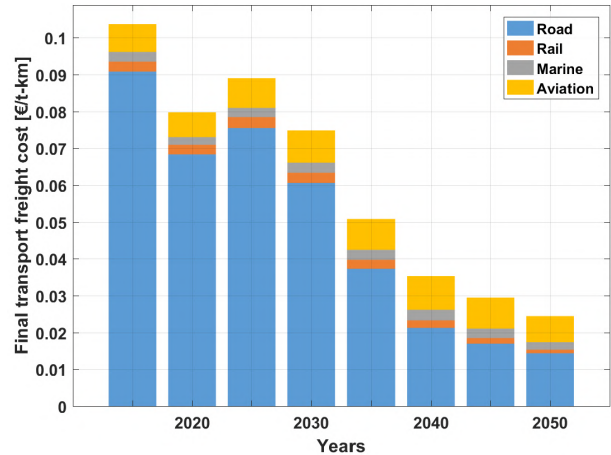
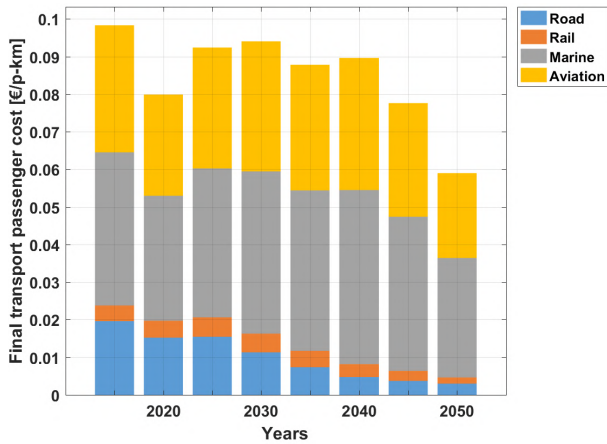

Figure 3.5-21: Sub-Saharan Africa – Final transport passenger cost (left) and final transport freight cost (right) during the energy transition from 2015 to 2050.

Desalination

The desalination demand in Sub-Saharan Africa is relatively small compared to other regions of the world. Therefore, the installed capacity of power generation for the desalination sector increases from around 0.1 GW in 2015 to around 6 GW by

2050 as shown in Figure 3.5-22. Solar PV and wind along with some fossil gas comprise the majority of installed capacities from 2030 until 2050. Primary electricity generation to meet the desalination demand in the initial period of the transition is from fossil gas up to 2030, beyond which PV and wind dominate as highlighted in Figure 3.5-22.

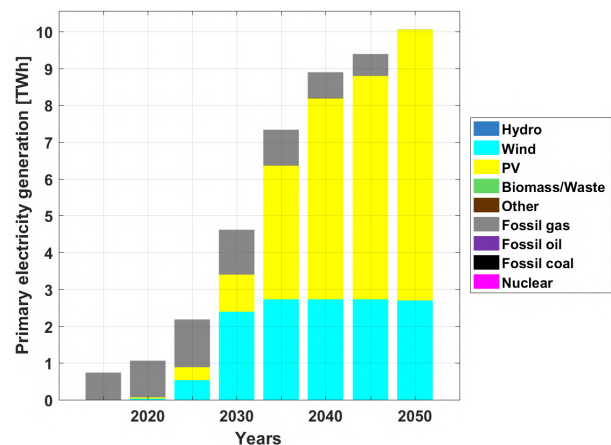
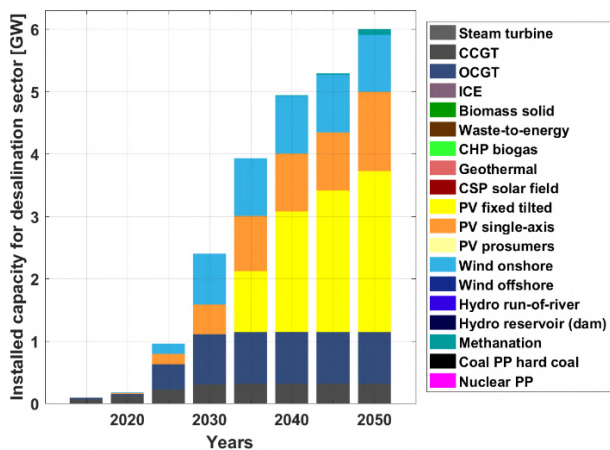

Figure 3.5-22: Sub-Saharan Africa – Technology-wise installed capacities for the desalination sector (left) and primary electricity generation for the desalination sector (right) during the energy transition from 2015 to 2050.

The installed storage capacity for desalination occurs mainly from 2035 onwards, with most of the capacity added in the final five-year period until 2050, as shown in Figure 3.5-23. Gas comprises more than 95% of the 0.24 TWh installed storage

capacity in 2050, whereas batteries contribute the majority of the storage output, which reaches around 3.7 TWh_{el} by 2050 as shown in Figure 3.5-23.

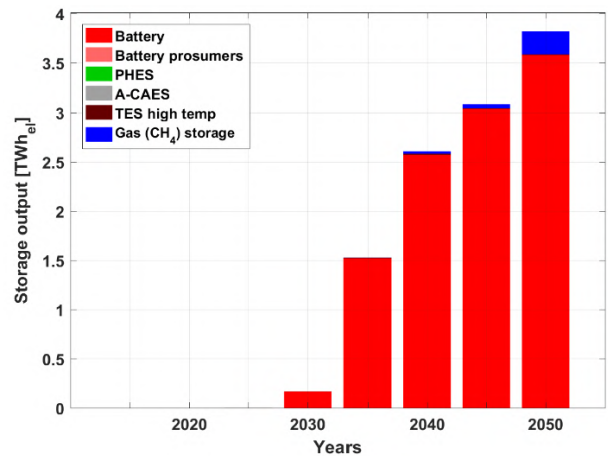
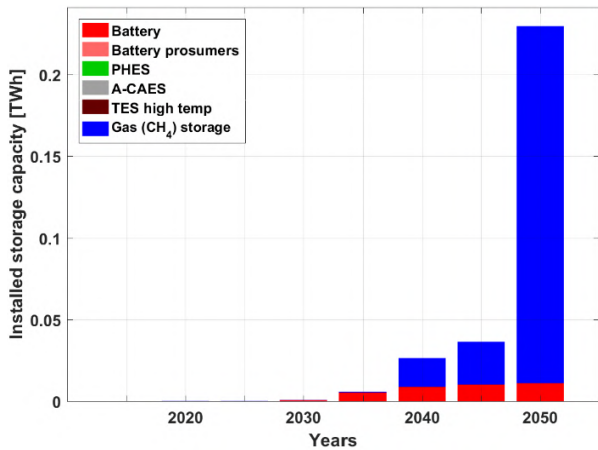

Figure 3.5-23: Sub-Saharan Africa – Installed storage capacity (left) and storage output (right) during the energy transition from 2015 to 2050.

Investments in power generation for the desalination sector occur mainly during 2025 to 2040, as shown in Figure 3.5-24. A majority of the investment is in wind, PV, and batteries, which

reaches a high of around 1.2 b€ in 2035. The levelised cost of water declines through the transition from around 0.75 €/m³ in 2015 to around 0.44 €/m³ by 2050, as shown in Figure 3.5-24.

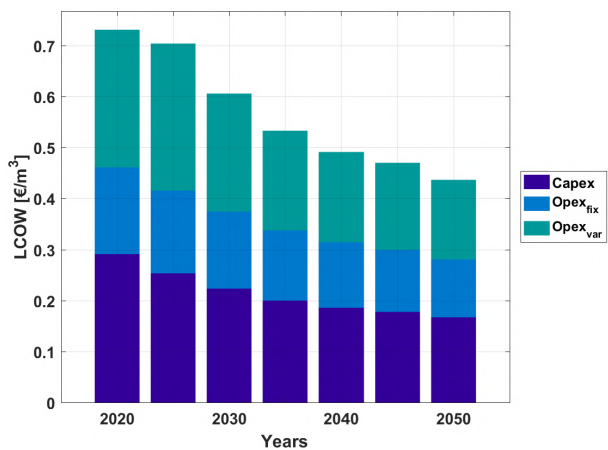
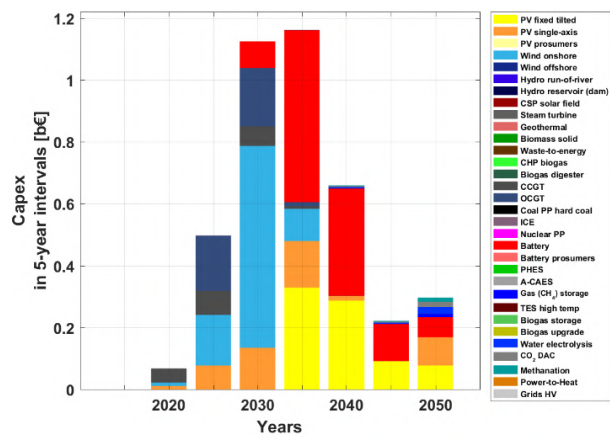

Figure 3.5-24: Sub-Saharan Africa – Capital costs for five-year intervals (left) and levelised cost of water (right) during the energy transition from 2015 to 2050.

Regional outlook

Electricity generation capacities are installed across Sub-Saharan Africa to satisfy the demand for power, heat, transport, and desalination up to 2050. Solar PV capacities are predominant across all regions of Sub-Saharan Africa that have better solar resources through the year, while wind energy capacities are mainly in South Africa, Sudan, North of West Africa, Kenya-Uganda and the Horn of Africa that have much better wind conditions, as shown in Figure 3.5-25. Overall, solar PV and hydropower capacities along with some wind

energy capacities constitute the majority of installed capacity in 2050 across Sub-Saharan Africa. Similarly, higher shares of solar PV generation are present across all regions and higher shares of wind energy are in the northern and eastern regions along with South Africa as highlighted in Figure 3.5-25. This could enhance the complementarity of solar PV and wind in an interconnected energy system across Sub-Saharan Africa.

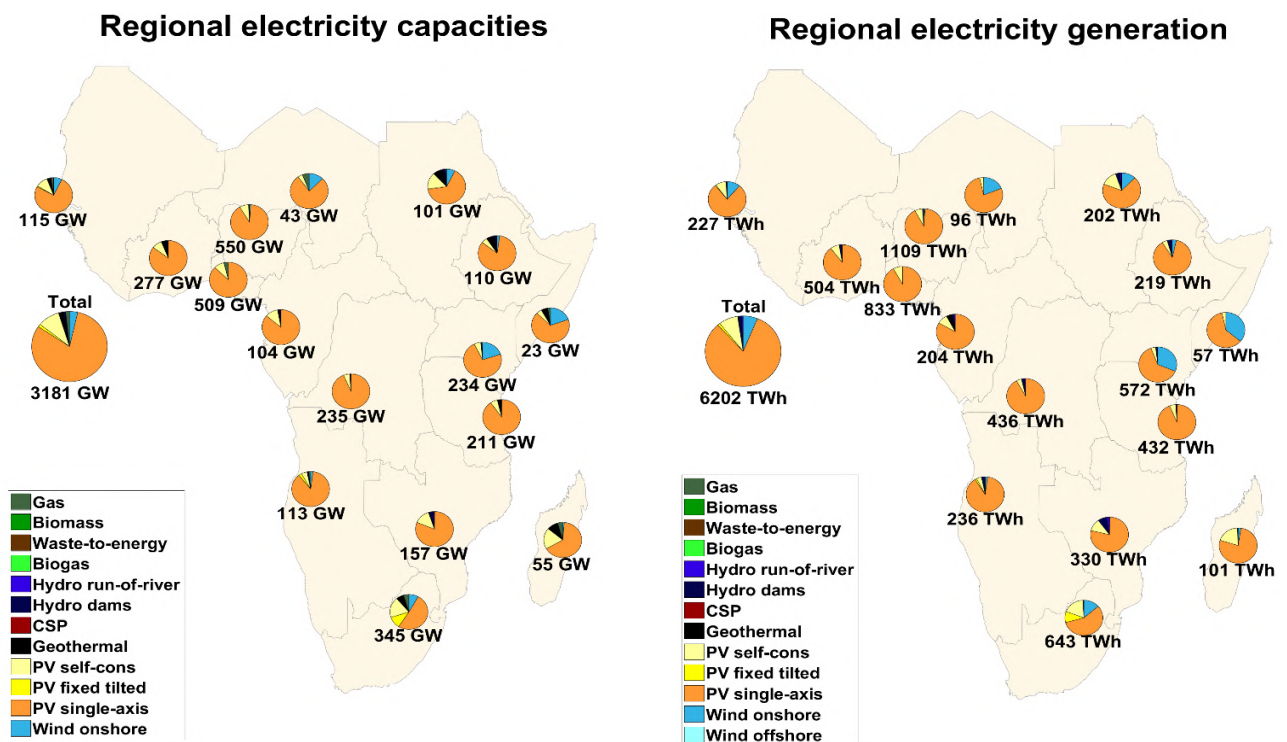

Figure 3.5-25: Sub-Saharan Africa – Regional electricity generation capacities (left) and electricity generation (right) in 2050.

Solar PV capacities are well distributed across the different regions of Sub-Saharan Africa and achieve a total installed capacity base of almost 2920 GW in 2050. Moreover, there are capacities across the regions and countries with good solar conditions throughout the year, as shown in Figure 3.5-26.

Whereas, wind energy capacities achieve a total installed capacity base of just over 110 GW in 2050 and are predominantly in the northern and eastern regions of Sub-Saharan Africa, which have some wind potential. This can be observed in Figure 3.5-26.

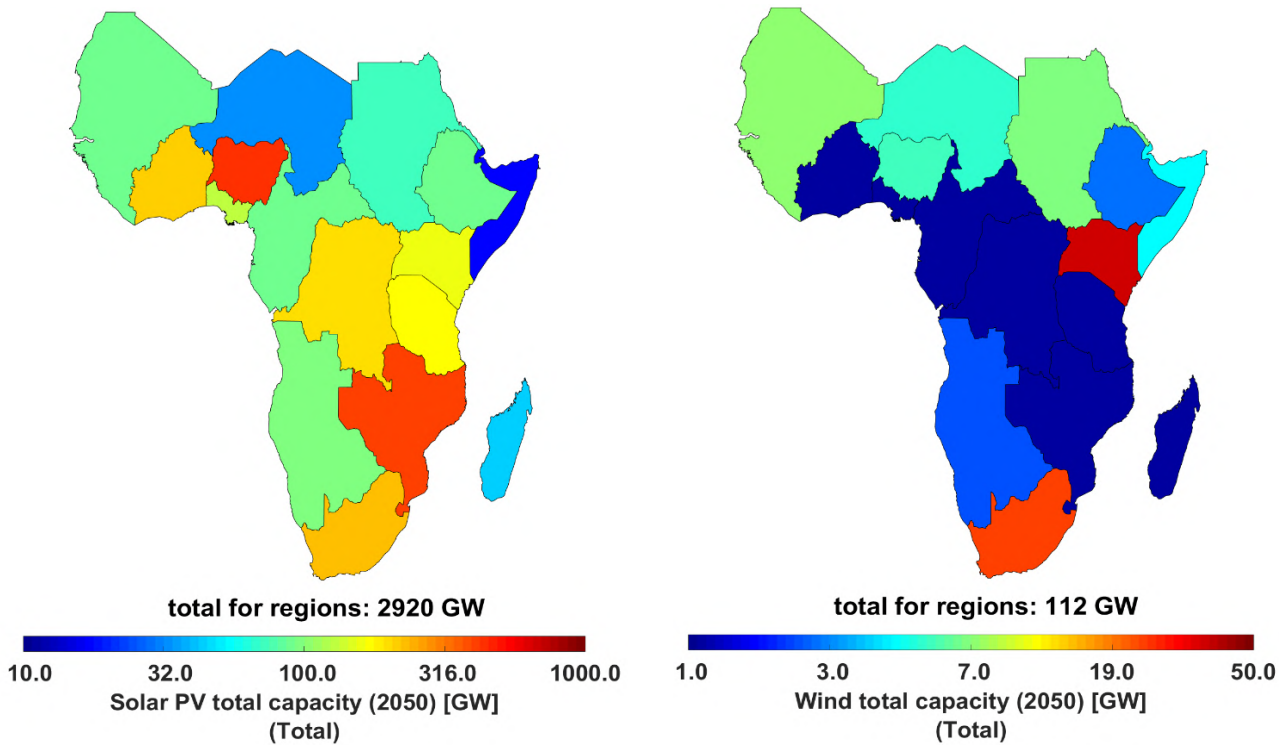

Figure 3.5-26: Sub-Saharan Africa – Regional variation of electricity generation capacities of solar PV (top) and wind energy (bottom) in 2050.

The electricity generation across the power, heat, transport, and desalination sectors of Sub-Saharan Africa are predominantly from PV and wind in 2050, which are well distributed across the different countries and regions as shown in Figure 3.5-27. Solar PV, which supplies an average of 91.5% of electricity generation across Sub-Saharan Africa, is more common across all the regions. While wind

energy, which contributes an average of 6.2% of electricity generation across Sub-Saharan Africa, is mainly found in South Africa, Sudan, North of West Africa, Kenya-Uganda and the Horn of Africa. Overall, solar PV and wind generate most of the electricity needed across Sub-Saharan Africa by 2050, which is around 97.5% of total electricity generation.

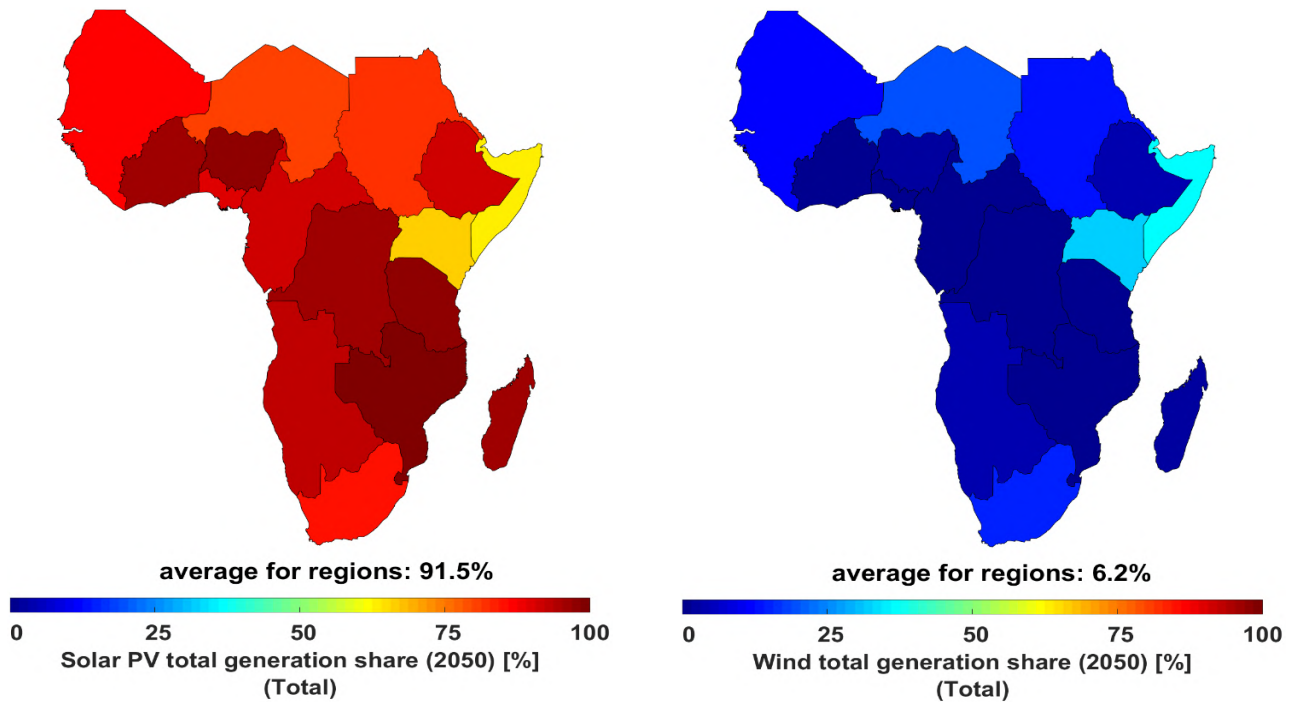
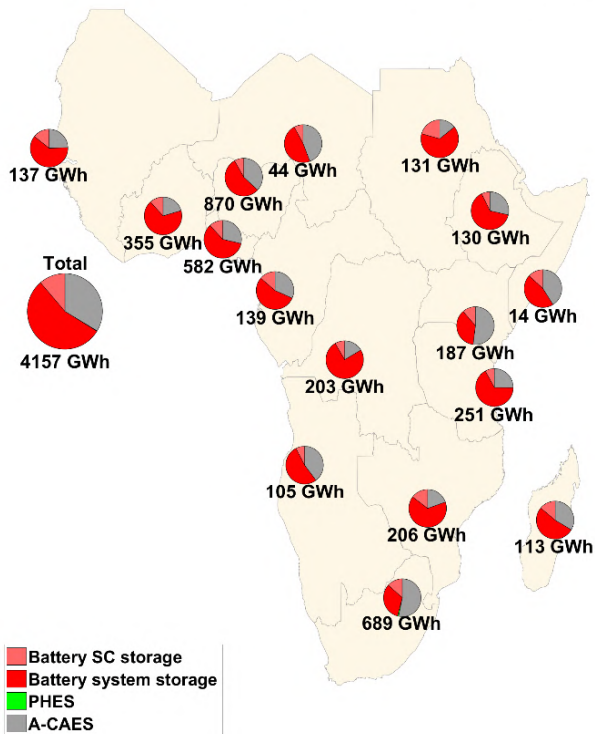

Figure 3.5-27: Sub-Saharan Africa – Regional variation of electricity generation shares of solar PV (left) and wind energy (right) in 2050.

Utility-scale and prosumer batteries contribute a major share of electricity storage capacities, with some shares of A-CAES by 2050, as shown in Figure 3.5-28. Storage capacities are much higher in the western parts of Sub-Saharan Africa, to complement higher shares of installed solar PV capacities. The highest installed capacities are

found in Nigeria and South Africa. Batteries, both prosumers and utility-scale, deliver the largest shares of output by 2050, as shown in Figure 3.5-28. A-CAES contributes complementary shares of electricity storage output through the transition, across the different regions of Sub-Saharan Africa.

Regional electricity storage capacities



Regional electricity storage annual generation

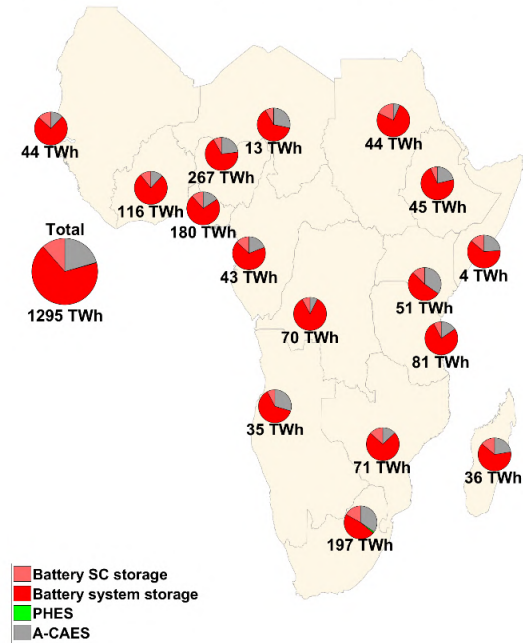

Figure 3.5-28: Sub-Saharan Africa – Regional electricity storage capacities (left) and electricity storage annual throughput (right) in 2050.

The storage output across the power, heat, transport, and desalination sectors of Sub-Saharan Africa is predominantly from batteries (both utility-scale and prosumers) and some synthetic natural gas supply in 2050, as shown in Figure 3.5-29. Batteries, which supply an average of 19.4% of the storage output across Sub-Saharan Africa, are more common in the western regions of Sub-Saharan

Africa and South Africa. Synthetic natural gas, which supplies an average of 0.1% of the total electricity demand across Sub-Saharan Africa, is distributed across all the regions. This is complemented with a supply share of storage from biomethane of less than 0.1% in 2050 across Sub-Saharan Africa.

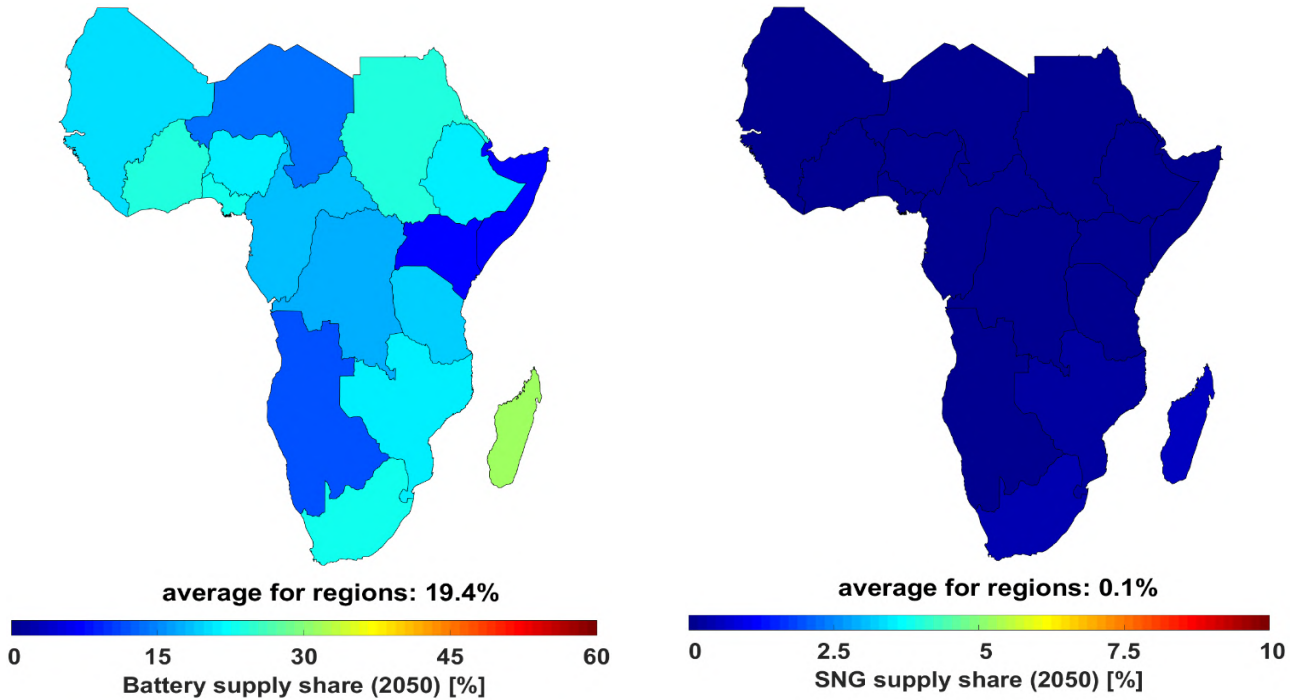

Figure 3.5-29: Sub-Saharan Africa – Regional variation of storage supply shares of batteries (left) and synthetic natural gas (right) in 2050.

Greenhouse Gas Emissions

The results of the energy transition towards a 100% renewable energy system indicate a sharp decline in GHG emissions until 2050, reaching zero GHG emissions by 2050 across the power, heat, transport, and desalination sectors in Sub-Saharan Africa as shown in Figure 3.3-30. The power sector

undergoes a deep decarbonisation by 2030, whereas for the heat and transport sectors this occurs mostly between 2030 and 2050. Moreover, the remaining cumulative GHG emissions comprise around 11 GtCO_{2eq} from 2018 to 2050. Therefore, the energy transition pathway for Sub-Saharan Africa is in adherence to the ambitious Paris Agreement target of 1.5°C.

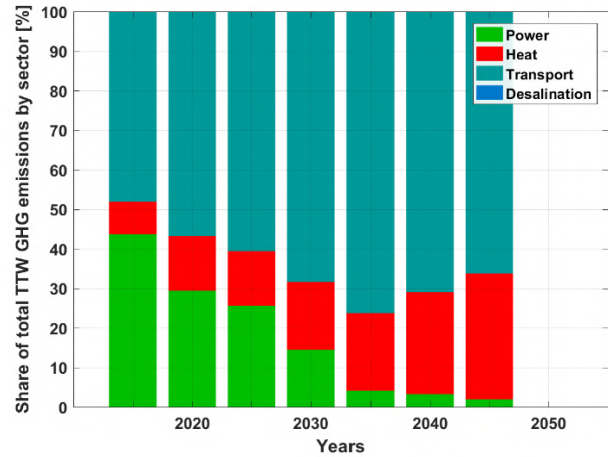
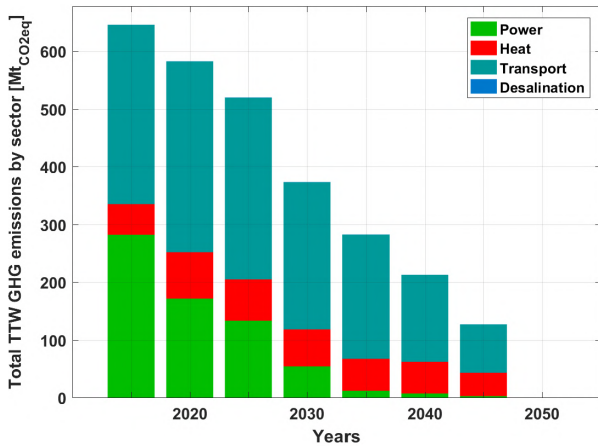

Figure 3.5-30: Sub-Saharan Africa – Sector-wise GHG emissions (left) and the share of GHG emissions of different sectors (right) during the energy transition from 2015 to 2050. Tank to Wheel (TTW) considers GHG emissions from readily available fuels and does not consider GHG emissions from the upstream production and delivery of fuels.

GHG emissions from the power sector decline through the transition from around 280 MtCO₂ eq./a in 2015 to zero by 2050 as shown in Figure 3.5-31. Similarly, GHG emissions from the heat sector decline through the transition from over 80 MtCO₂ eq./a in 2020 to zero by 2050 as shown in Figure 3.5-31.

GHG emissions from the transport sector decline through the transition from around 330 MtCO₂ eq./a in 2020 to zero by 2050, as shown in Figure 3.5-32. Similarly, GHG emissions from the desalination sector, which are much lower than those of other sectors, decline through the transition from around 0.47 MtCO₂ eq./a in 2025 to zero by 2050, also visible in Figure 3.5-32.

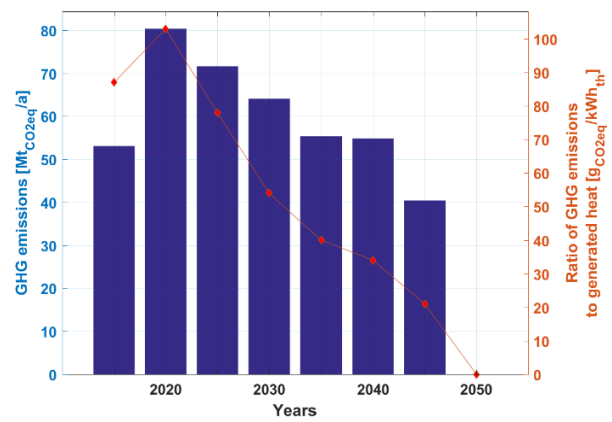
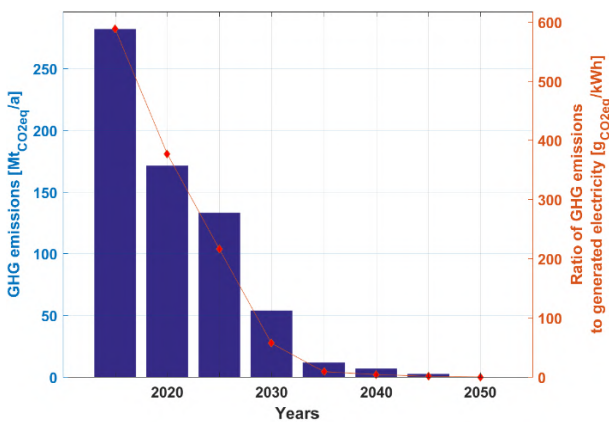

Figure 3.5-31: Sub-Saharan Africa – GHG emissions in the power sector (left) and GHG emissions in the heat sector (right) during the energy transition from 2015 to 2050.

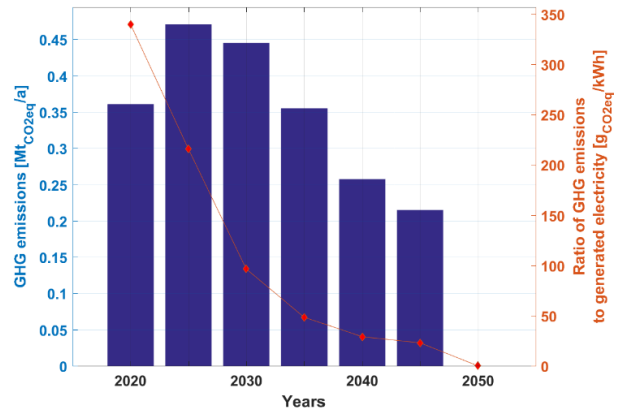
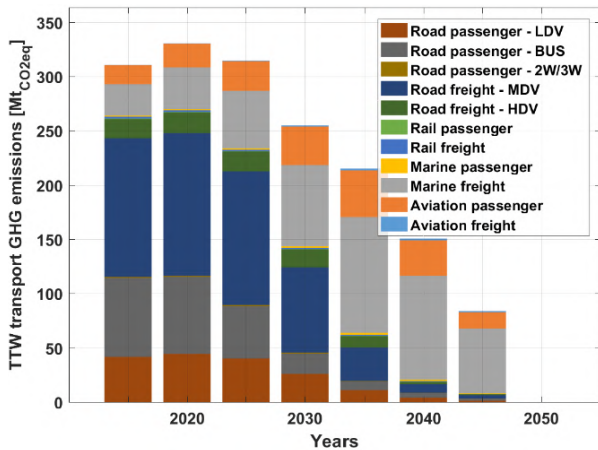

Figure 3.5-32: Sub-Saharan Africa – GHG emissions in the transport sector (left) and GHG emissions in the desalination sector (right) during the energy transition from 2015 to 2050. Tank to Wheel (TTW) considers GHG emissions from readily available fuels and does not consider GHG emissions from the upstream production and delivery of fuels.

Jobs in the Power Sector across Sub-Saharan Africa

Solar PV is observed to be the prime job creator through the transition period, with 65% of the total jobs created by 2050, as depicted in Figure 3.5-33. A fair share of jobs are created by wind power (283 thousand jobs in 2025) and bioenergy (377 thousand jobs in 2025) initially, which tend to stabilise later on, as solar PV is far more cost

competitive beyond 2030. Jobs created by storage technologies mainly driven by batteries, increase in share beyond 2030 and continue to grow up to 2050 (862 thousand jobs in the battery sector). On the other hand, jobs associated with fossil fuels, mainly coal and gas power generation, rapidly diminish across the region. Overall, the number of direct energy jobs are seen to grow massively from just under 1.2 million in 2015 to nearly 5.5 million by 2050.

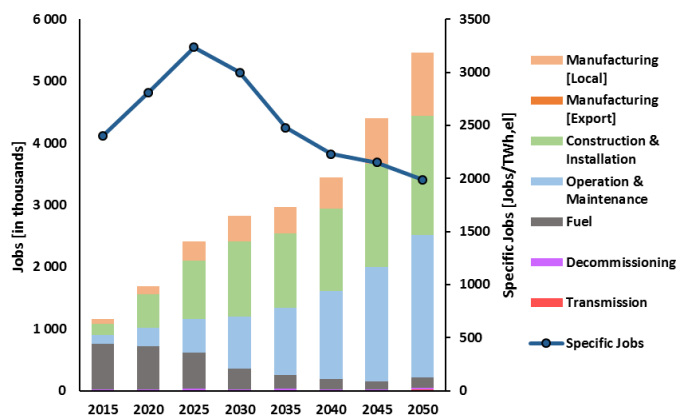
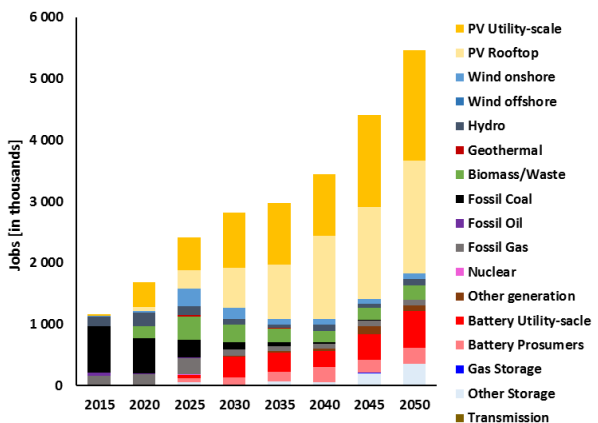

Figure 3.5-33: Sub-Saharan Africa – Jobs created by various power generation and storage technologies (left) and jobs created based on different categories with the development of electricity demand specific jobs (right) during the energy transition from 2015 to 2050.

With ramp up of installations up to 2035, the majority of jobs is created in the construction and installation of power generation technologies. Manufacturing jobs have a relatively low share in the initial periods up to 2020, as the share of imports is high. From 2025 onwards, as domestic production capabilities build up, a higher share of manufacturing jobs is observed until 2050 with 19% of total jobs. The share of fuel related jobs continues to diminish through the transition period from 63% of total jobs in 2015 to just 3% of total jobs by 2050, as conventional power plants are replaced by renewable and storage technologies.

By contrast, the share of operation and maintenance jobs grow through the transition period reaching 42% of total jobs by 2050. This could be the boost required for employment prospects in Sub-Saharan Africa, which are presently stagnating due to low productivity attributed to the region's lack of economic diversification ⁶⁹. The electricity demand specific jobs increase from 2399 jobs/TWh_{el} in 2015 to 3235 jobs/TWh_{el} in 2025 with the rapid ramp up in renewable energy installations. Beyond 2025, it declines steadily to around 1990 jobs/TWh_{el} by 2050, as shown in Figure 3.5-33.

3.6. South Asian Association for Regional Cooperation (SAARC)

SAARC is a region with a number of fast-paced growing economies, with around a 9% share of global GDP ⁶³. Population in SAARC is 1742 million in 2015 representing a share of 24% in world population, which is estimated to be also 24% in 2050. With a rapidly growing population, unprecedented economic progress and need for reliable modern energy access, sustainable energy development is already on top of the agenda for many of the countries, led by progressive policies towards renewable energy development adopted by India in the recent years ^{70,55,71}. The energy sector in the SAARC region is vital to its overall development. Therefore, effective energy planning, optimal design of the energy infrastructure, wise

utilisation of all available renewable energy resources and maximum synergy between the SAARC countries will foster sustainable development across the region. The detailed results for the energy transition across SAARC are available in a supplementary data file, the link for the file can be found in the Appendix.

Penetration of renewables is not just a matter of replacing hydrocarbons with zero-emission sources of energy supply – it also represents a significant change in resource efficiency. This is illustrated by the overall electrification across the power, heat, transport, and desalination sectors as shown in Figure 3.6-1.

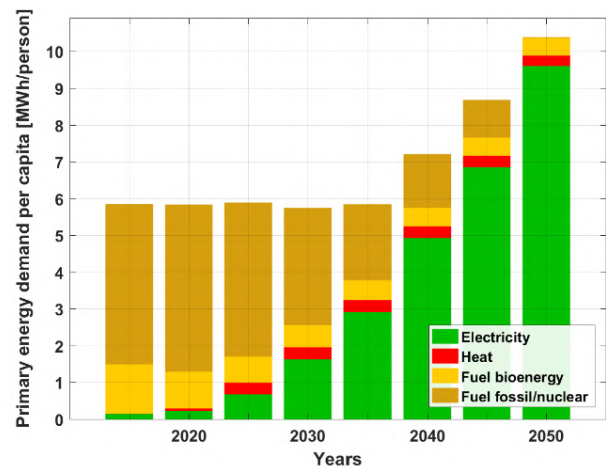
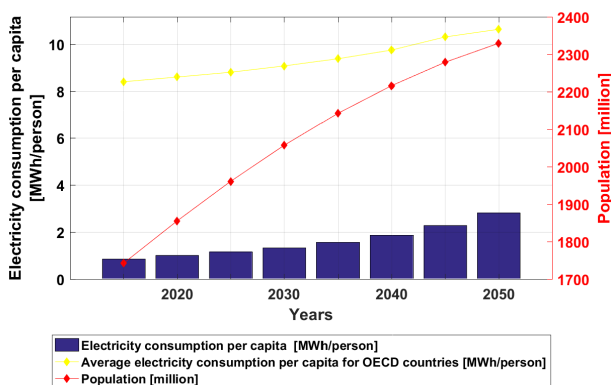
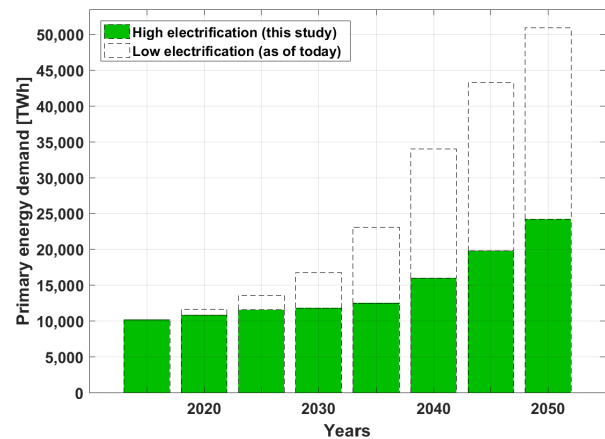
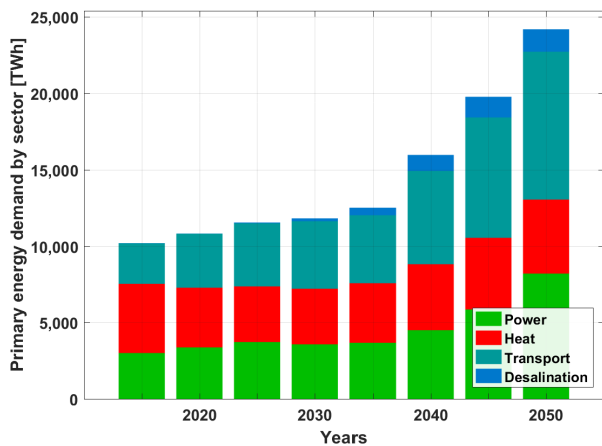

Figure 3.6-1: SAARC – Primary energy demand sector-wise (top left), efficiency gain in primary energy demand (top right), electricity consumption per capita with population (bottom left) and primary energy demand per capita (bottom right) during the energy transition from 2015 to 2050.

The primary energy demand assuming high electrification, which is the basis for this study, increases marginally from 10,000 TWh in 2015 to around 13,000 TWh by 2035, beyond which it increases substantially up to 24,000 TWh by 2050 as shown in Figure 3.6-1. On the contrary, with low shares of electrification resulting from the adoption of current practices until 2050, the primary energy demand would reach over 50,000 TWh by 2050. The massive gain in energy efficiency is primarily due to a high level of electrification of more than 93% resulting in the reduction of around 26,000 TWh by 2050, in comparison to the continuation of current practices with low shares of electrification. The population across SAARC is expected to grow considerably from 1742 to 2329 million by 2050. Consequently, the average per capita primary energy demand remains stable around 6 MWh/person from 2015 until 2035 and further, it increases up to 10 MWh/person by 2050. Additionally, a substantial demand from fuel

conversion technologies arises beyond 2040, in producing renewable-based fuels for the transport sector across SAARC.

Energy Supply

The electricity generation capacity across SAARC satisfies demand from all energy sectors including power, heat, transport and desalination. The total installed capacity grows massively from over 400 GW in 2015 to around 13,000 GW by 2050 as shown in Figure 3.6-2. In the initial period of the transition, some shares of wind capacities are installed up to 2030, but in the later part of the transition solar PV dominates the shares of installed capacities reaching almost 11,910 GW by 2050. On the other hand, the shares of fossil fuels and nuclear decline through the transition to zero by 2050. Some shares of gas remain, but the fuel switches from fossil-based gas to synthetic natural gas produced with renewable electricity and biomethane.

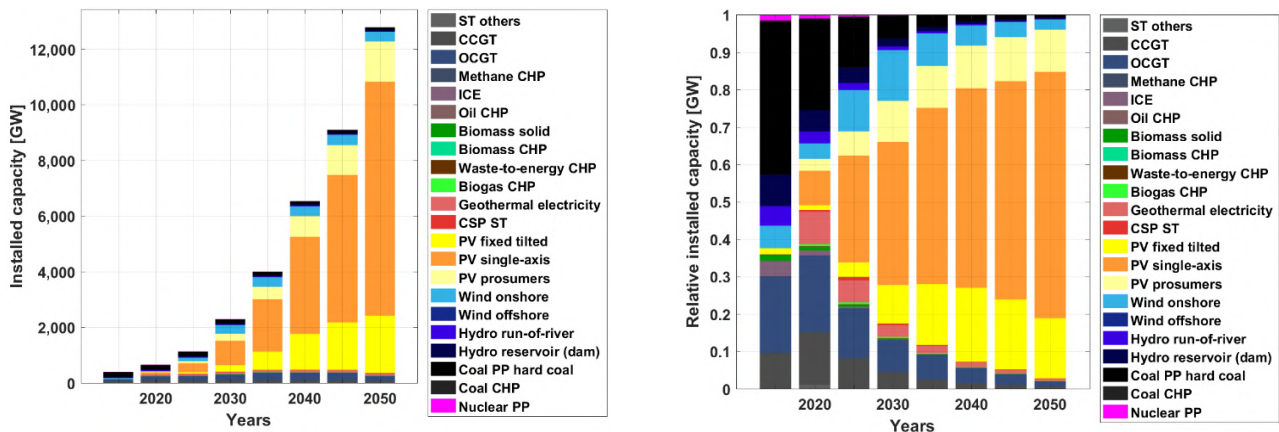

Figure 3.6-2: SAARC – Technology-wise installed capacities (left) and technology-wise shares of installed capacities (right) during the energy transition from 2015 to 2050.

Electricity generation from the various technologies to cover the demand of power, heat, transport, and desalination sectors is shown in Figure 3.6-3. Solar PV supply increases through the transition from 47% in 2030 to about 91% by 2050, becoming the lowest cost energy source. The share of wind generated power, increases to 19% by 2030 and decreases up to 6% by 2050. Additionally, some share of hydropower complements the other resources through the transition period. In the heat

sector, electric heating plays a significant role through the transition with a share of nearly 30% in 2050, complemented by biomass based heating and heat pumps, as indicated in Figure 3.6-3. On the other hand, coal-based heating decreases through the transition from over 63% in 2015 to zero by 2050, as coal-based CHP and DH is replaced by electric heating, biomass-based DH and heat pumps.

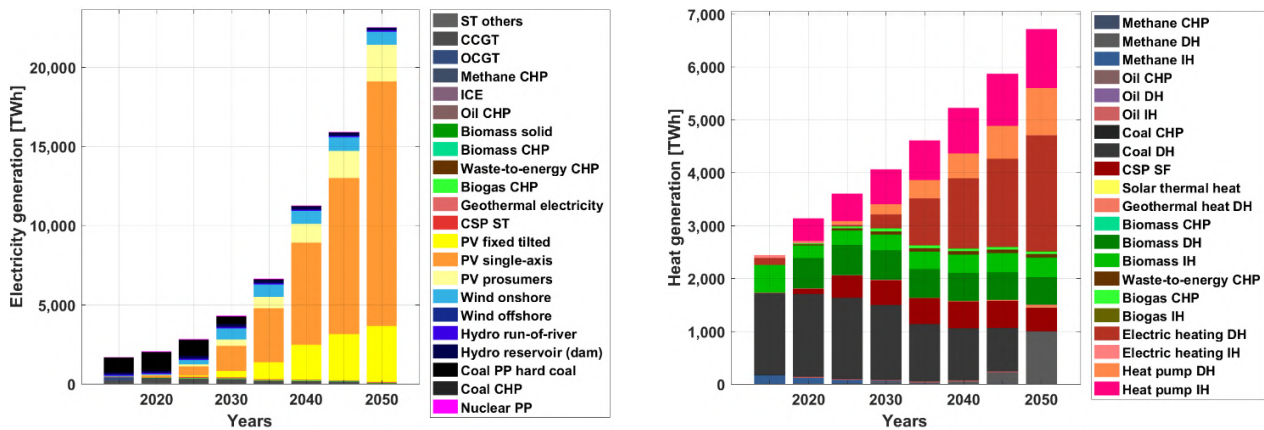

Figure 3.6-3: SAARC – Technology-wise electricity generation (left) and technology-wise heat generation (right) during the energy transition from 2015 to 2050.

Energy Storage

Energy storage technologies play a critical role in enabling a secure energy supply throughout SAARC, fully based on renewable energy across different sectors. As highlighted in Figure 3.6-4, storage output covers around 6,700 TWh_{el} of total electricity demand in 2050. The ratio of electricity Similarly, heat storage plays a vital role in ensuring

demand covered by energy storage to electricity generation increases significantly to around 33% by 2035 and remains around 28-30% until 2050. Additionally, about 6% of electricity demand is covered by heat storage conversion technologies by 2050. Batteries emerge as the most relevant electricity storage technology contributing about 99% of the total electricity storage output by 2050. (TES) emerges as the most relevant heat storage

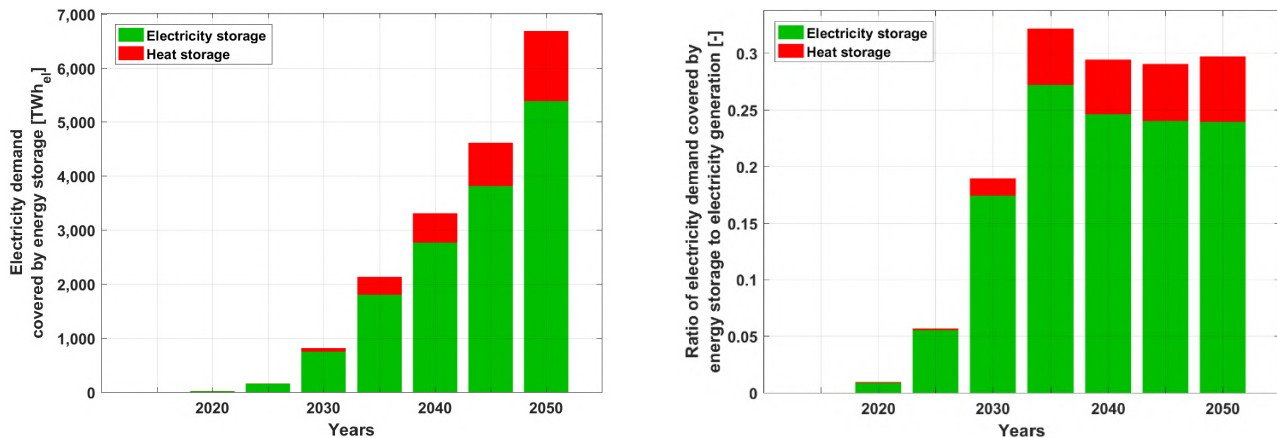

Figure 3.6-4: SAARC – Electricity demand covered by energy storage (left) and ratio of electricity demand covered by different forms of energy storage (right) during the energy transition from 2015 to 2050

heat demand is covered across all the sectors. As indicated in Figure 3.6-5, storage output covers more than 2500 TWh_{th} of the total heat demand in 2050 and heat storage technologies are crucial to meet this demand. The ratio of heat demand covered by energy storage to heat generation increases substantially to over 30% by 2050, also shown in Figure 3.6-5. Thermal energy storage

technology with around 56% of heat storage output by 2050. Furthermore, power-to-gas (PtG) contributes around 44% of heat storage output in 2050. As fossil fuel usage for heat generation is completely eliminated in the final five-year period from 2045-2050, there is an increase in heat storage utilisation with minor shares from electricity to heat storage.

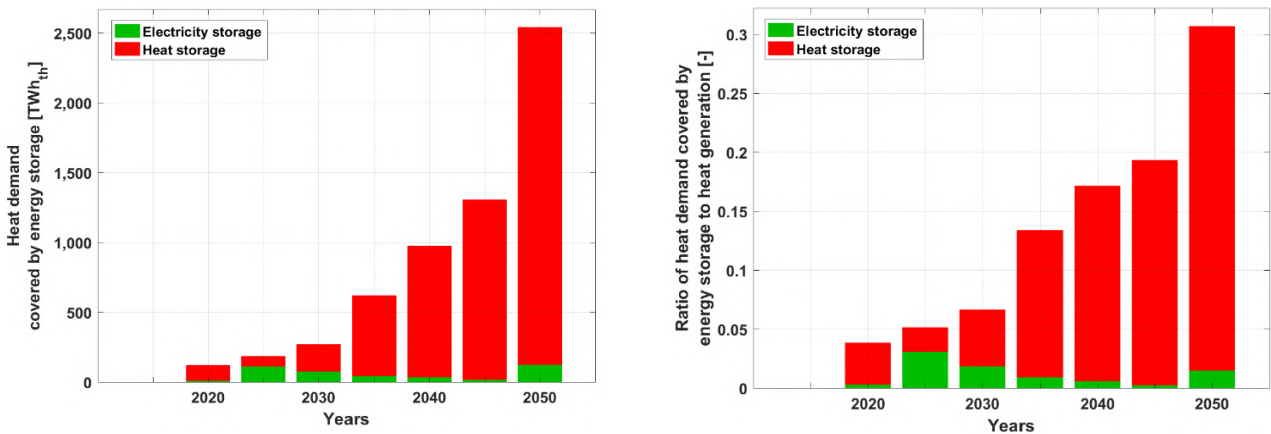

Figure 3.6-5: SAARC – Heat demand covered by energy storage (left) and the ratio of heat demand covered by different forms of energy storage (right) during the energy transition from 2015 to 2050.

Costs and Investments

The total annual system costs are in the range of 350-1,100 b€ through the transition period and are well distributed across the major sectors of power, heat, and transport, as desalination demand across SAARC takes prominence from 2030 onwards. As indicated by Figure 3.6-6, power, heat, and transport costs are in the range of around 350-1000

b€ through the transition. In addition, as indicated in Figure 3.6-6 CAPEX increases through the transition, as fuel costs decline completely. The steady increase in CAPEX-related energy system costs indicate that fossil fuel imports and the respective negative impacts on trade balances will fade out through the transition. In addition, a low fossil fuel import dependency will lead to a higher level of energy security across SAARC enabling robust economic development in the region.

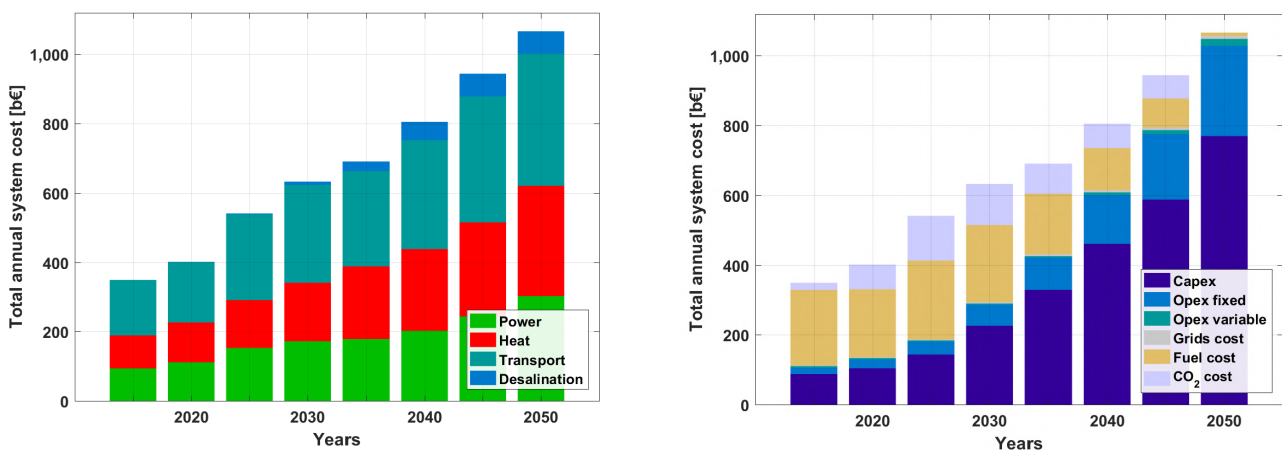

Figure 3.6-6: SAARC – Annual system costs, sector-wise (left) and functionality-wise (right) during the energy transition from 2015 to 2050.

As increasing shares of power generation capacities are added globally, renewable energy sources become the least costing power generation sources⁶⁶. As indicated in Figure 3.6-7, levelised cost of energy remains around €43-57/MWh through the transition with 51 €/MWh by 2050, which is increasingly dominated by capital costs as fuel costs continue to decline through the transition period. This could mean increased self-reliance in

terms of energy for SAARC by 2050 as mentioned earlier. Capital costs are well spread across a range of technologies with major investments for PV, wind energy, batteries, heat pumps, and synthetic fuel conversion technologies up to 2050, as shown in Figure 3.6-7. The cumulative investments are about 9,770 b€ through the transition from 2016-2050.

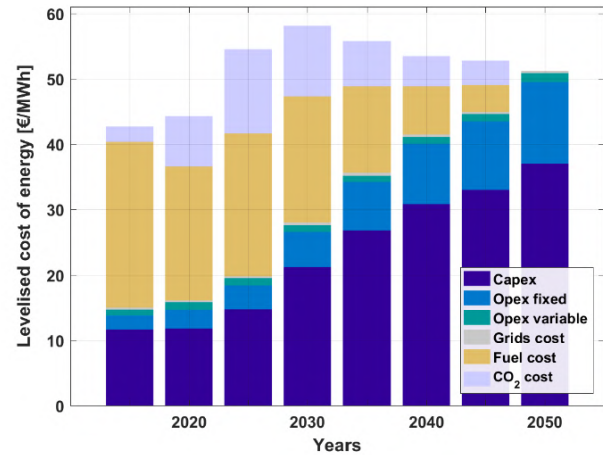
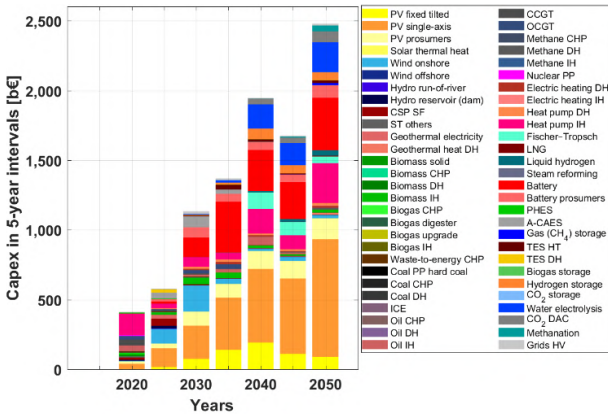

Figure 3.6-7: SAARC – Capital costs for five-year intervals (left) and levelised cost of energy (right) during the energy transition from 2015 to 2050.

Outlook across Sectors

Different trends in the power, heat, transport, and desalination sectors across SAARC emerge through the transition. As the sectors move towards having higher shares of renewable energy, different technologies have vital roles in ensuring the stability of the energy system. A closer look at the individual sectors provides further insights into the energy transition across SAARC towards 100% renewable energy.

Power and Heat

The total installed power generation capacity increases from nearly 400 GW in 2015 to around 6,700 GW by 2050, as shown in Figure 3.6-8. Across the power sector, solar PV with over 5,900 GW and wind with over 290 GW constitute the majority of installed capacities by 2050. In addition, complemented by some shares of hydropower. In the heat sector, heat pumps, electric heating, solar thermal and biomass-based heating constitute the majority of installed capacities by 2050, also shown in Figure 3.6-8.

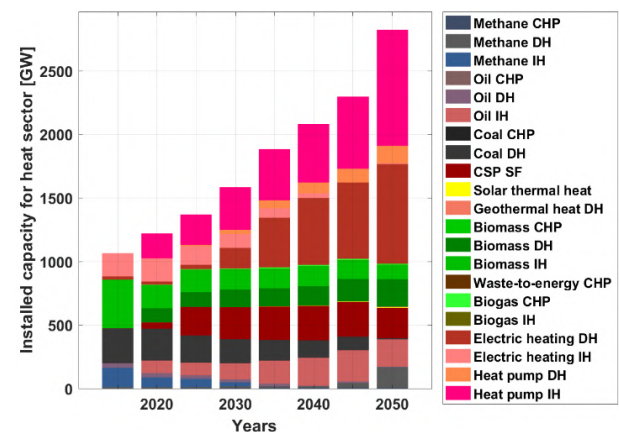
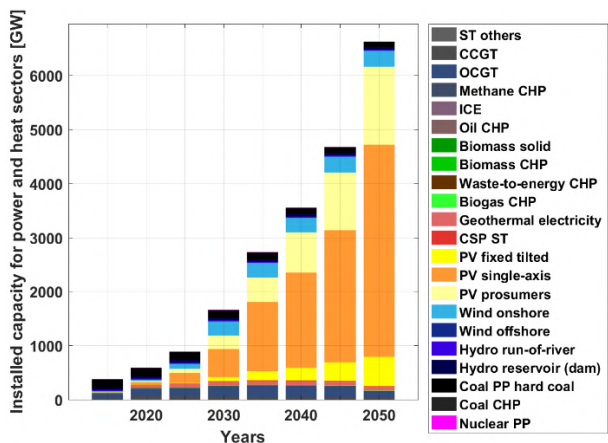

Figure 3.6-8: SAARC – Technology-wise installed capacities for power (left) and heat (right) during the energy transition from 2015 to 2050.

The transition across SAARC results in a power and heat sector dominated by fossil fuels with some shares of nuclear in 2015 moving towards a solar PV and wind energy dominated sector by 2050, complemented by hydropower and bioenergy as shown in Figure 3.6-9. The primary electricity generation increases from around 1,750 TWh in 2015 to around 10,800 TWh by 2050, which is

primarily from PV and wind along with some hydropower. Similarly, heat generation increases from around 2,300 TWh in 2015 to around 6,700 TWh by 2050, which comes predominantly from electric heating along with some shares from heat pumps, solar thermal, non-fossil gas and biomass-based heating, also shown in Figure 3.6-9.

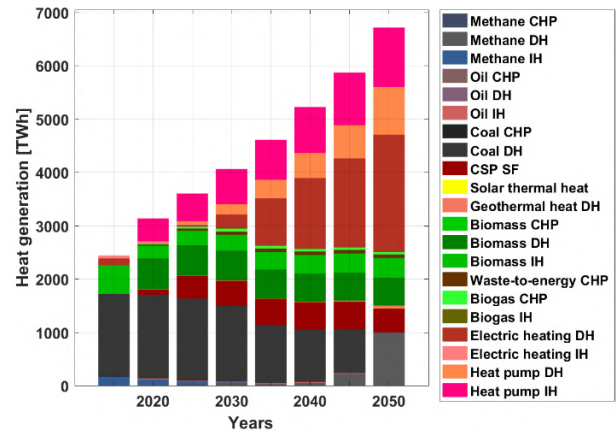
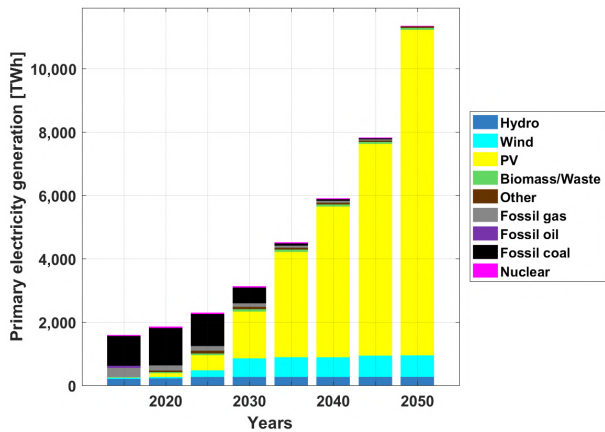

Figure 3.6-9: SAARC – Primary electricity generation (left) and technology-wise heat generation (right) during the energy transition from 2015 to 2050.

The installed electricity storage capacity increases from just 0.1 TWh in 2015 to over 12 TWh by 2050, as shown in Figure 3.6-10. Major shares of utility-scale and prosumer batteries with minor shares of PHEs and A-CAES are installed through the transition. The installed heat storage increases gradually until 2045 to around 20 TWh, but in the

final five-year period up to 2050, a massive capacity of gas storage of nearly 115 TWh is added, as shown in Figure 3.6-10. This substantial capacity addition is mainly to provide heat storage across SAARC covering the industrial heat demand in the absence of fossil fuels. Some minor shares of TES are installed through the transition.

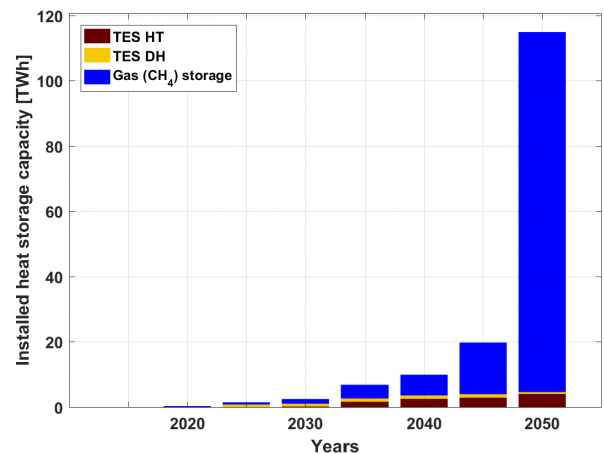
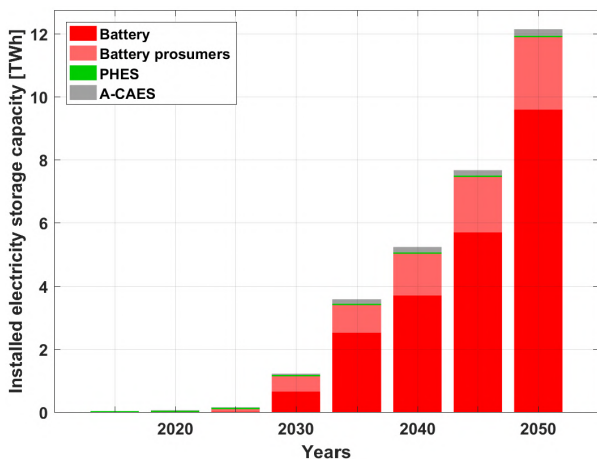

Figure 3.6-10: SAARC – Installed electricity storage capacities (left) and heat storage capacities (right) during the energy transition from 2015 to 2050.

Utility-scale and prosumer batteries contribute a major share of electricity storage output with nearly 99% by 2050, as highlighted by Figure 3.6-11. In addition, PHES and A-CAES contribute just minor shares through the transition. TES emerges as the most relevant heat storage technology with around

80-95% of heat storage output until 2045 and around 53% in 2050 as shown in Figure 3.6-10. Gas storage contributes around 47% of the heat storage output in 2050 covering predominantly industrial heat demand, replacing fossil fuels in the last five-year period.

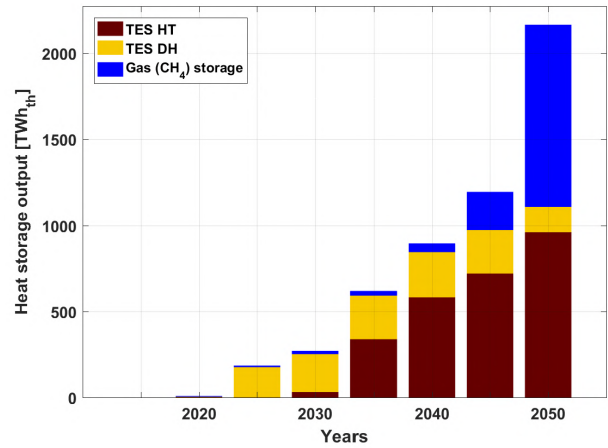
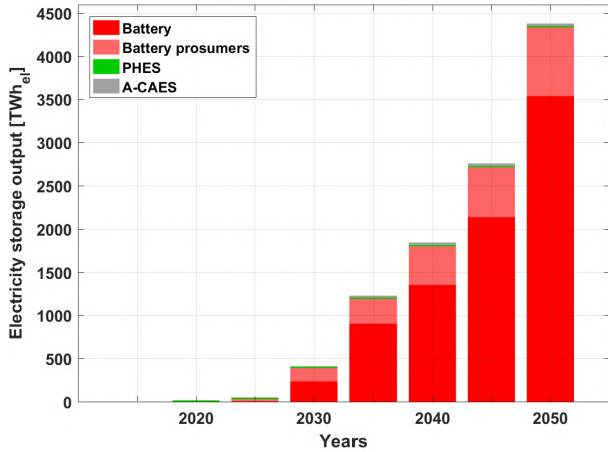

Figure 3.6-11: SAARC – Electricity storage output (left) and heat storage output (right) during the energy transition from 2015 to 2050.

LCOE of the power sector decreases substantially from around 69 €/MWh in 2015 to around 46 €/MWh by 2050, as shown in Figure 3.6-12. LCOE is predominantly comprised of CAPEX as fuel costs decline through the transition. Whereas, LCOH of the heat sector increases significantly from around 23 €/MWh in 2015 to around 49 €/MWh by 2050,

as shown in Figure 3.6-12. LCOH is predominantly comprised of CAPEX as fuel costs decline through the transition. Despite a substantial increase in heat demand across SAARC, mainly driven by industrial process heat, the LCOH increase up to 2050 is not very dramatic.

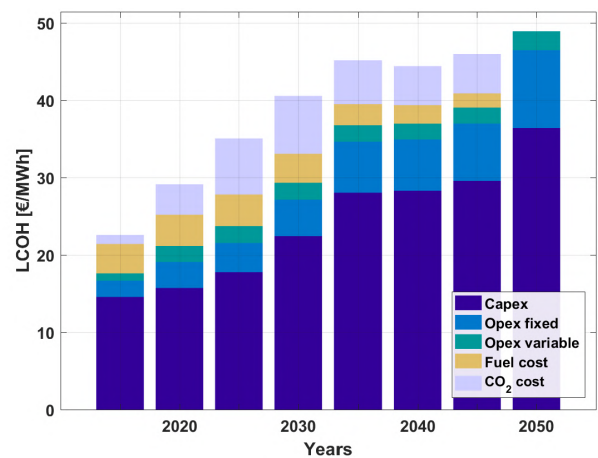
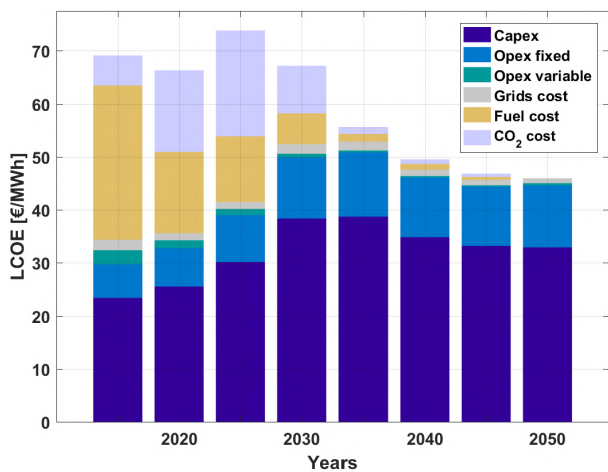

Figure 3.6-12: SAARC – Levelised cost of electricity (left) and levelised cost of heat (right) during the energy transition from 2015 to 2050.

Investments are well spread across a range of power generation technologies with the majority share in solar PV that dominates investments up to 2050 along with some shares in wind and hydropower, as shown in Figure 3.6-13. Investments in the heat sector are mainly in heat pumps and some shares in solar thermal and

biomass heating up to 2050, also shown in Figure 3.6-13. The steep increase in heat pump investments in the final five-year period until 2050 is mainly to cover the heat demand in the absence of fossil fuels as well as the lower costs of heat pumps by 2050.

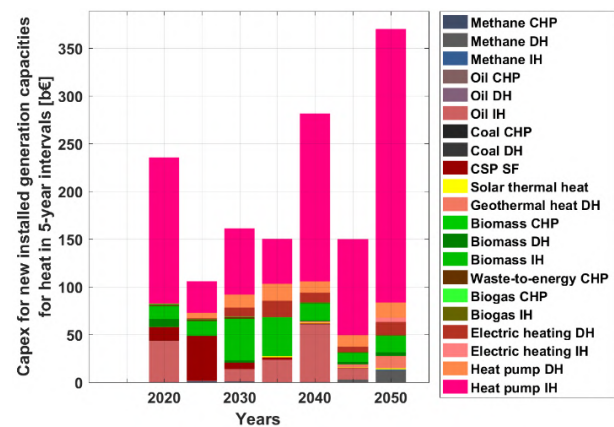
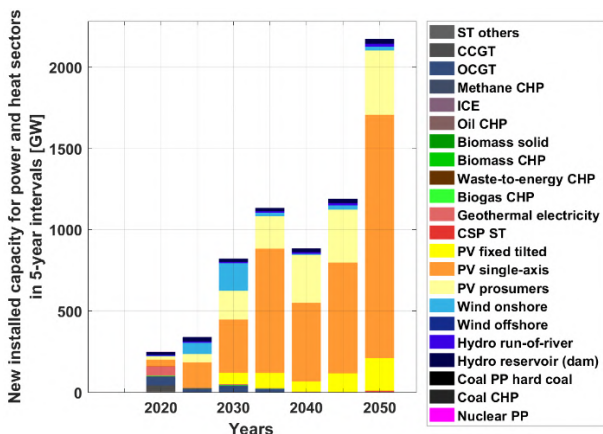

Figure 3.6-13: SAARC – Capital costs of installed generation capacities in five-year intervals for electricity (left) and heat (right) during the energy transition from 2015 to 2050.

Transport

The final energy demand of the transport sector in 2015 across SAARC is around 2,500 TWh. However, this demand increases marginally through the transition to around 4,000 TWh until 2035, mainly due to the efficiency gains brought about by electrification of the sector and further increases substantially up to 6000 TWh by 2050 as shown in Figure 3.6-14. On the contrary, fossil fuel consumption in the transport sector across SAARC declines through the transition from about 96% in

2015 to zero by 2050. While, liquid fuels produced by renewable electricity contribute around 30% of final energy demand in 2050. In addition, hydrogen constitutes more than 26% of final energy demand in 2050. Sustainably produced biofuels contribute a minor share to enable a complete elimination of fossil fuel usage in the transport sector. Electrification of the transport sector creates an electricity demand of over 9,100 TWh_{el} by 2050. The massive demand for liquid fuels kicks in from 2040 onwards up until 2050, as indicated in Figure 3.6-14.

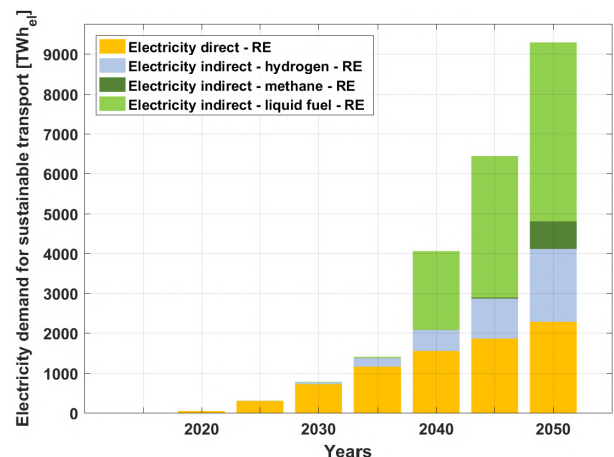
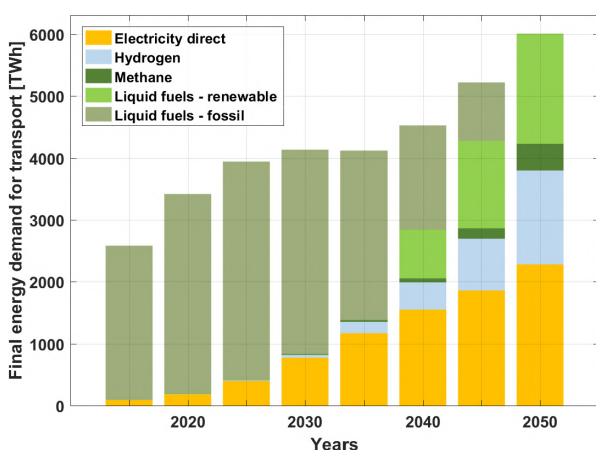

Figure 3.6-14: SAARC – Final energy demand for transport (left) and electricity demand for sustainable transport (right) during the energy transition from 2015 to 2050.

Installed power generation capacity for the transport sector increases substantially through the transition to around 5,250 GW by 2050, as shown in Figure 3.6-15. Solar PV and wind form the majority share of the power generation capacity for the transport sector, as they are the least costing

energy sources by 2050. Similarly, electricity generation increases substantially up to almost 9,700 TWh by 2050 also to be seen in Figure 3.6-15. Solar PV and wind energy generate all the electricity required to meet the demand of the transport sector in 2050.

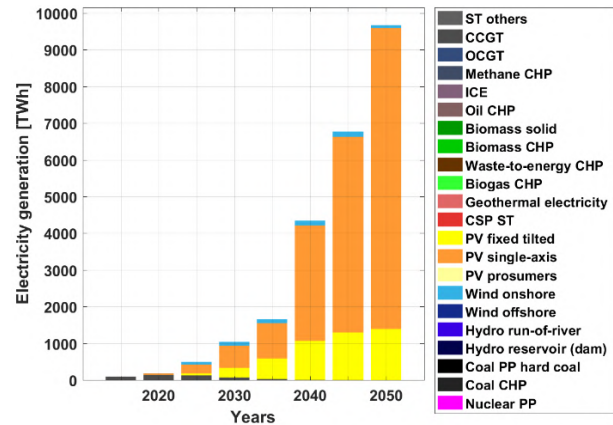
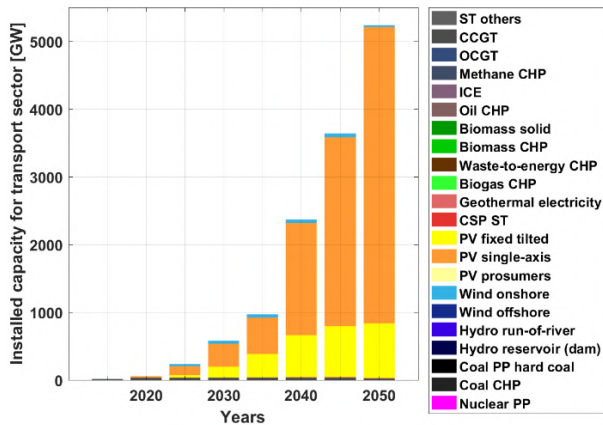

Figure 3.6-15: SAARC – Transport sector installed power generation capacity (left) and electricity generation (right) during the energy transition from 2015 to 2050.

A critical aspect to complement the electrification of the transport sector is the installation of storage technologies. As seen in Figure 3.6-16, the installed capacities of electricity storage increase through the transition to around 4.7 TWh by 2050. The majority of installed capacities are utility-scale batteries and A-CAES. Similarly, electricity storage output increases through the transition to almost 1,600 TWh_{el} by 2050 as shown in Figure 3.6-16.

Utility-scale batteries play a vital role as they contribute a major portion of the output through the transition, with around 1,300 TWh_{el} by 2050. The relatively low electricity storage of less than 20% of generated electricity for the transport sector is enabled by the flexible operation of batteries, water electrolyser units, and hydrogen buffer storage for synthetic fuel production.

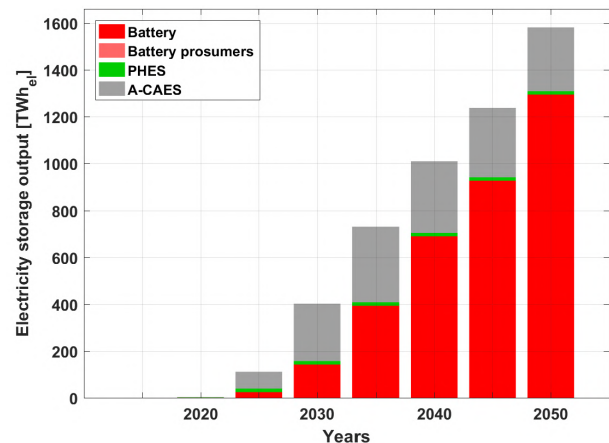
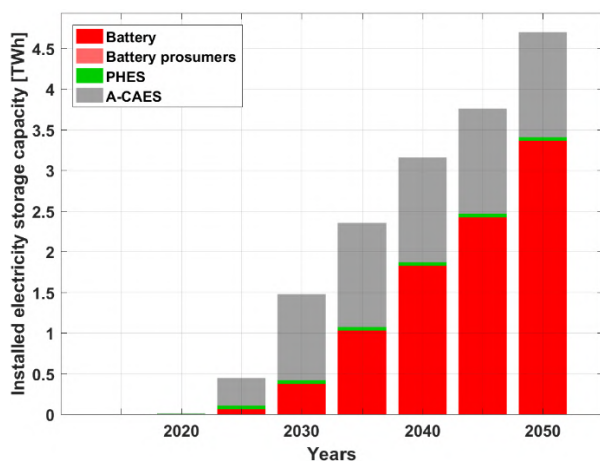

Figure 3.6-16: SAARC – Transport sector installed electricity storage capacity (left) and electricity storage output (right) during the energy transition from 2015 to 2050.

An essential aspect in the transition of the transport sector towards higher electrification completely based on renewable energy is the production of synthetic fuels, hydrogen and sustainable biofuels. As indicated in Figure 3.6-17, the installed capacities of fuel conversion technologies increase substantially from 2040 onwards to over 2,800 GW by 2050. Water electrolysis forms the majority share

of fuel conversion capacities through the transition. Additionally, heat is needed during the production of synthetic fuels, mainly for energy-efficient CO₂ direct air capture, and this is enabled by managing process heat, which is otherwise not useable. Heat utilisation is in the range of 1,300 TWh_{th} by 2050, which is comprised of excess heat and recovered heat, as shown in Figure 3.6-17.

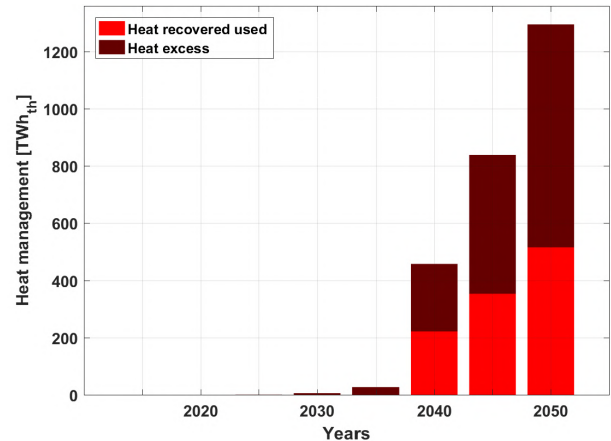
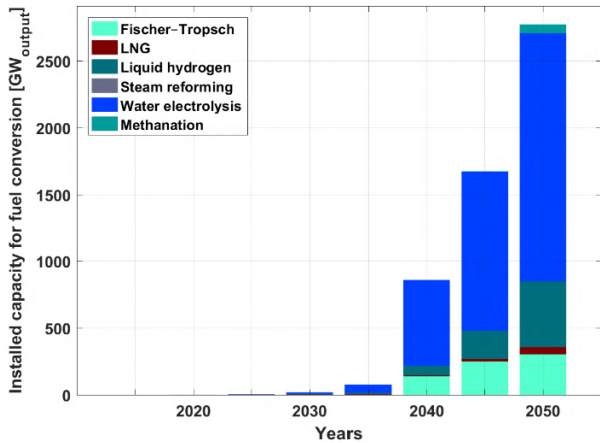

Figure 3.6-17: SAARC – Transport sector installed capacity for fuel conversion (left) and heat management (right) during the energy transition from 2015 to 2050.

Similarly, gas storage is necessary in the production of synthetic fuels. As shown in Figure 3.6-18, the installed storage capacity for gas increases through the transition to around 32 TWh by 2050. Hydrogen is the major gas stored through the transition, with some share for methane gas in 2050. CO₂ storage and CO₂ direct air capture, which are vital in the production of synthetic fuels, are installed from 2040 onwards. The installed

capacities for CO₂ storage and CO₂ direct air capture increase up to around 480 MtCO₂ by 2050, as shown in Figure 3.6-18. The major share of installed storage capacity is CO₂ direct air capture, which is on an annual basis as compared to CO₂ storage. Despite having a lower storage capacity, CO₂ storage has a substantial utilisation and correspondingly higher throughput.

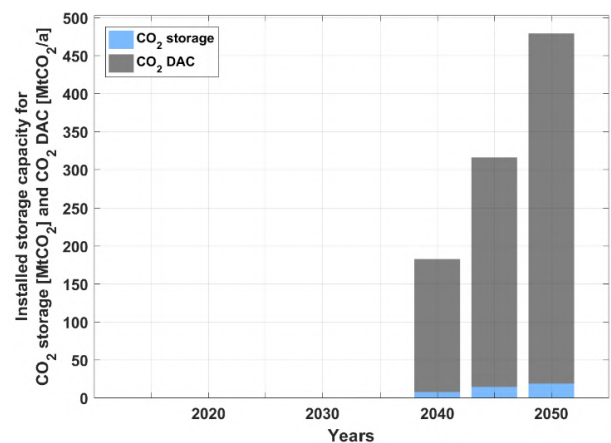
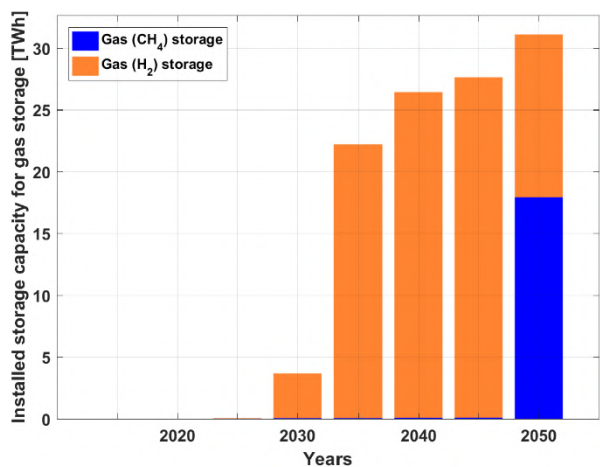

Figure 3.6-18: SAARC – Transport sector installed capacity for gas (methane and hydrogen) storage (left) and CO₂ direct air capture and CO₂ storage (right) during the energy transition from 2015 to 2050.

Fuel costs are a deciding factor in the overall energy mix for the transport sector across SAARC and their developing trends are highlighted in Figure 3.6-19. FT and SNG fuel costs decline through the transition up to 2050 and FT fuels are cost competitive with fossil liquid fuels including GHG emissions costs, at around 85 €/MWh in 2050. In addition, SNG is more cost effective than LNG in 2050. Electricity emerges as the most cost effective option with LCOE primary at around 11

€/MWh and along with complementary costs of storage and other system components, total LCOE is around 27 €/MWh in 2050. Similarly, H₂ fuel costs decline to be more cost competitive than fossil fuels, in the range of 52 €/MWh in 2050, while liquid H₂ is in the range of 57 €/MWh. CO₂ from DAC is a critical component for synthetic fuels at around 31 €/tCO_{2eq} in 2050, using waste heat, as shown in Figure 3.6-19.

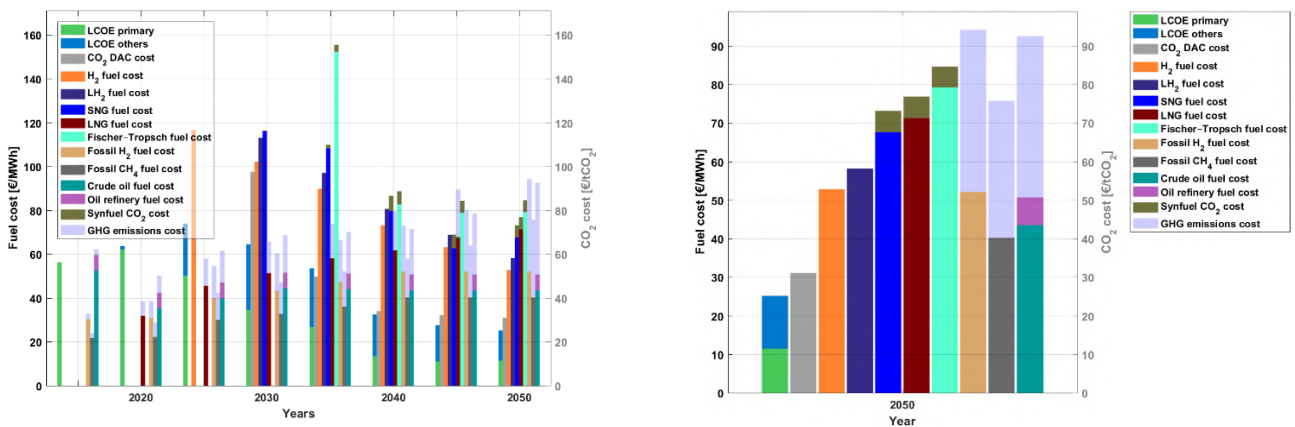

Figure 3.6-19: SAARC – Fuel costs for the transport sector during the energy transition from 2015 to 2050 (left) and fuel costs in 2050 (right).

The final energy costs for transport are in the range of 170-330 b€ through the transition period with an increase from around 170 b€ in 2015 to about 330 b€ by 2050, as shown in Figure 3.6-20. Furthermore, annual system costs transition from being heavily dominated by fuel costs in 2015 to a very diverse share of costs across various technologies for electricity, synthetic fuels and sustainable biofuel production by 2050, as

highlighted in Figure 3.6-20. The difference in annual final transport energy and system costs is predominantly due to additional aspects of the system beyond 2040, as FT units produce naphtha as a by-product, that adds to the overall system costs. The cost for naphtha is allocated to the industry sector as input for the chemical industry, since it is a valuable feedstock.

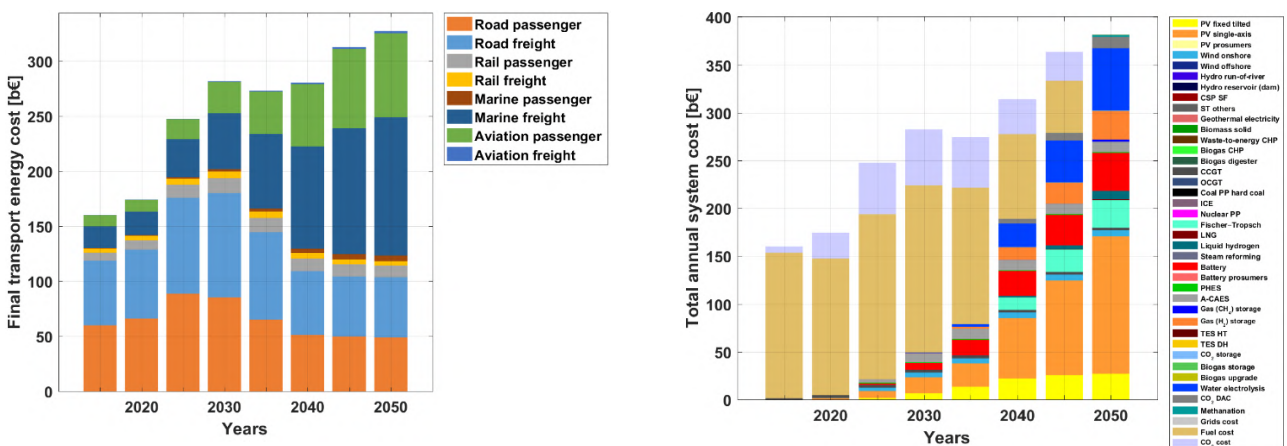

Figure 3.6-20: SAARC – Final transport energy costs based on mode of transport (left) and source of energy (right) during the energy transition from 2015 to 2050.

The final transport passenger costs decline from around 0.09 €/p-km in 2015 to 0.063 €/p-km by 2050, as shown in Figure 3.6-21. Final transport passenger costs decline for road transport through the transition, whereas for marine and aviation there is a marginal decrease. Similarly, final

transport freight costs decline from around 0.048 €/t-km in 2015 to 0.017 €/t-km by 2050, as shown in Figure 3.6-21. The final freight costs in the case of road declines through the transition, whereas it decreases slightly for rail and remains stable for aviation and marine.

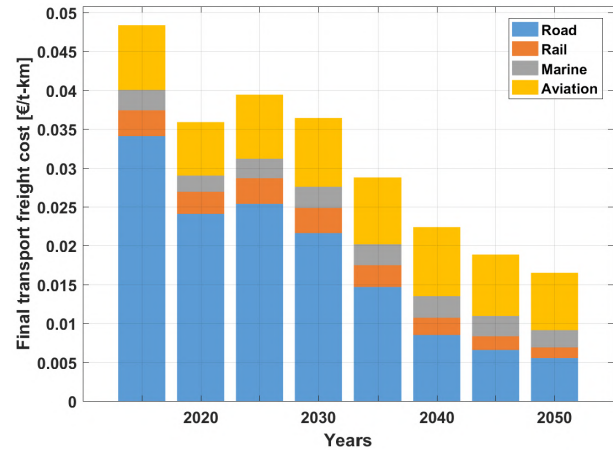
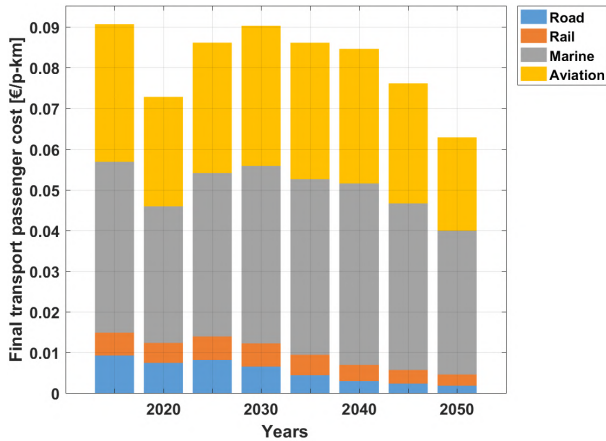

Figure 3.6-21: SAARC – Final transport passenger cost (left) and final transport freight cost (right) during the energy transition from 2015 to 2050.

Desalination

The desalination demand in SAARC is relatively small and mainly arises from 2030 onwards, as compared to other regions of the world. Therefore, the installed capacity of power generation for the desalination sector increases through the transition

to around 920 GW by 2050 as shown in Figure 3.6-22. Solar PV and wind comprise the majority of installed capacities from 2030 until 2050. Primary electricity generation to meet the desalination demand in the initial period of the transition is from fossil gas up to 2030, beyond which PV and wind dominate as highlighted in Figure 3.6-22.

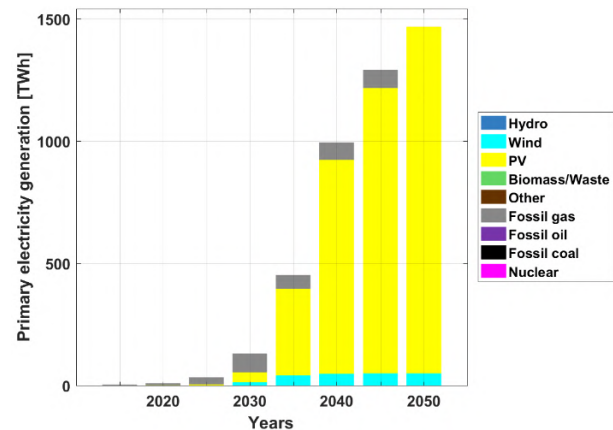
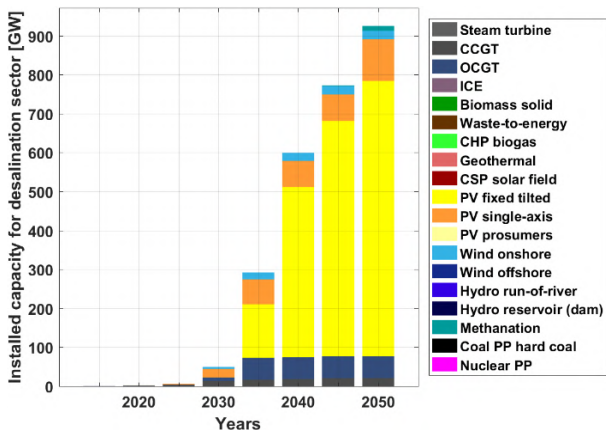

Figure 3.6-22: SAARC – Technology-wise installed capacities for the desalination sector (left) and primary electricity generation for the desalination sector (right) during the energy transition from 2015 to 2050.

The installed storage capacities for desalination occur mainly from 2035 onwards, with most of the capacity added in the final five-year period until 2050, as shown in Figure 3.6-23. Gas comprises more than 95% of the nearly 50 TWh installed storage capacity in 2050, whereas batteries contribute the majority of the storage output, which reaches more than 750 TWh_{el} by 2050 as shown in Figure 3.6-23.

Investments in power generation for the desalination sector occur mainly during 2030 to 2050, as shown in Figure 3.6-24. A majority of the investments are in wind, PV, and batteries, which reach a high of around 195 b€ in 2040. The levelised cost of water declines through the transition from around 1 €/m³ in 2015 to around 0.75 €/m³ by 2050, as shown in Figure 3.6-24.

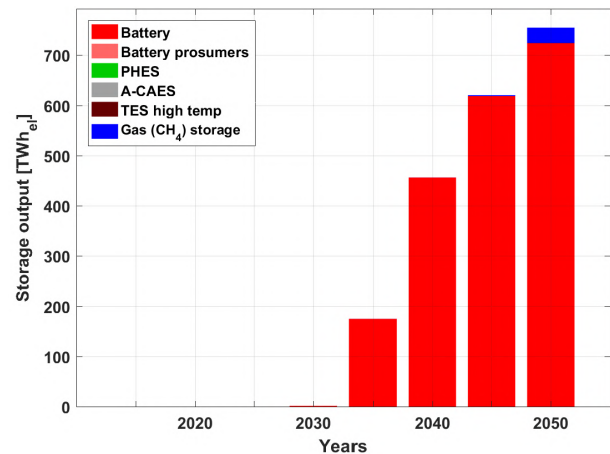
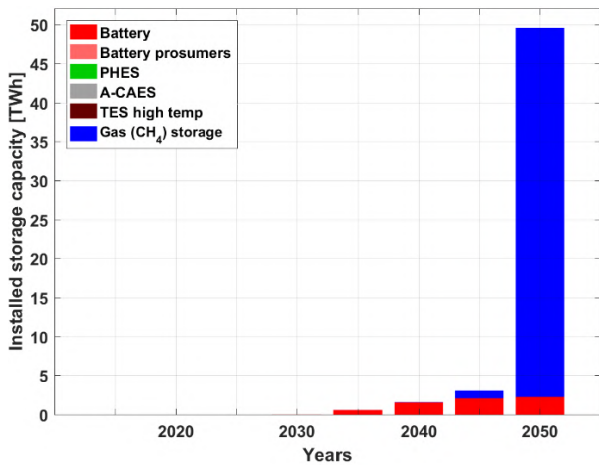

Figure 3.6-23: SAARC – Installed storage capacity (left) and storage output (right) during the energy transition from 2015 to 2050.

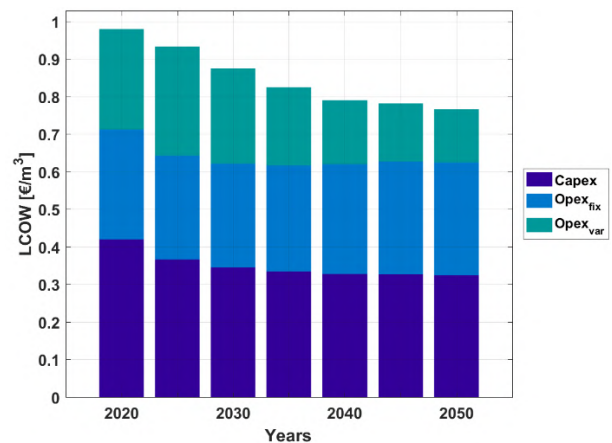
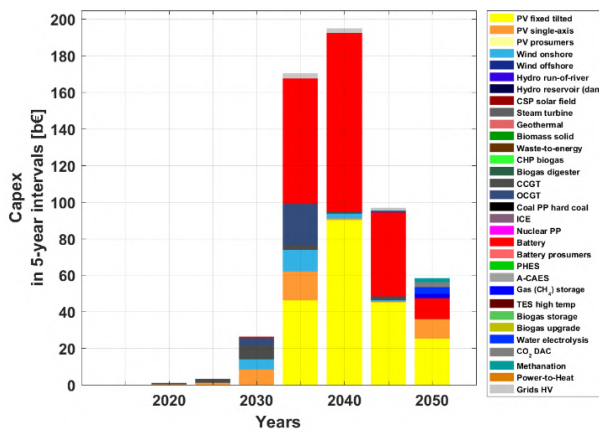

Figure 3.6-24: SAARC – Capital costs for five-year intervals (left) and levelised cost of water (right) during the energy transition from 2015 to 2050.

Regional Outlook

Electricity generation capacities are installed across SAARC to satisfy the demand for power, heat, transport, and desalination up to 2050. Solar PV capacities are predominant across all regions of SAARC that have good solar resources throughout the year, while wind energy capacities are mainly in the southern regions of SAARC that have much better wind conditions, as shown in Figure 3.6-25. Overall, solar PV and wind capacities along with some hydropower capacities constitute the majority

of installed capacity in 2050 across SAARC. Similarly, higher shares of solar PV generation are present across all the regions and higher shares of wind energy are in the southern regions as highlighted in Figure 3.6-25. This could enhance the complementarity of solar PV and wind in an interconnected SAARC energy system and also neutralise the effects of the monsoon season across the region.

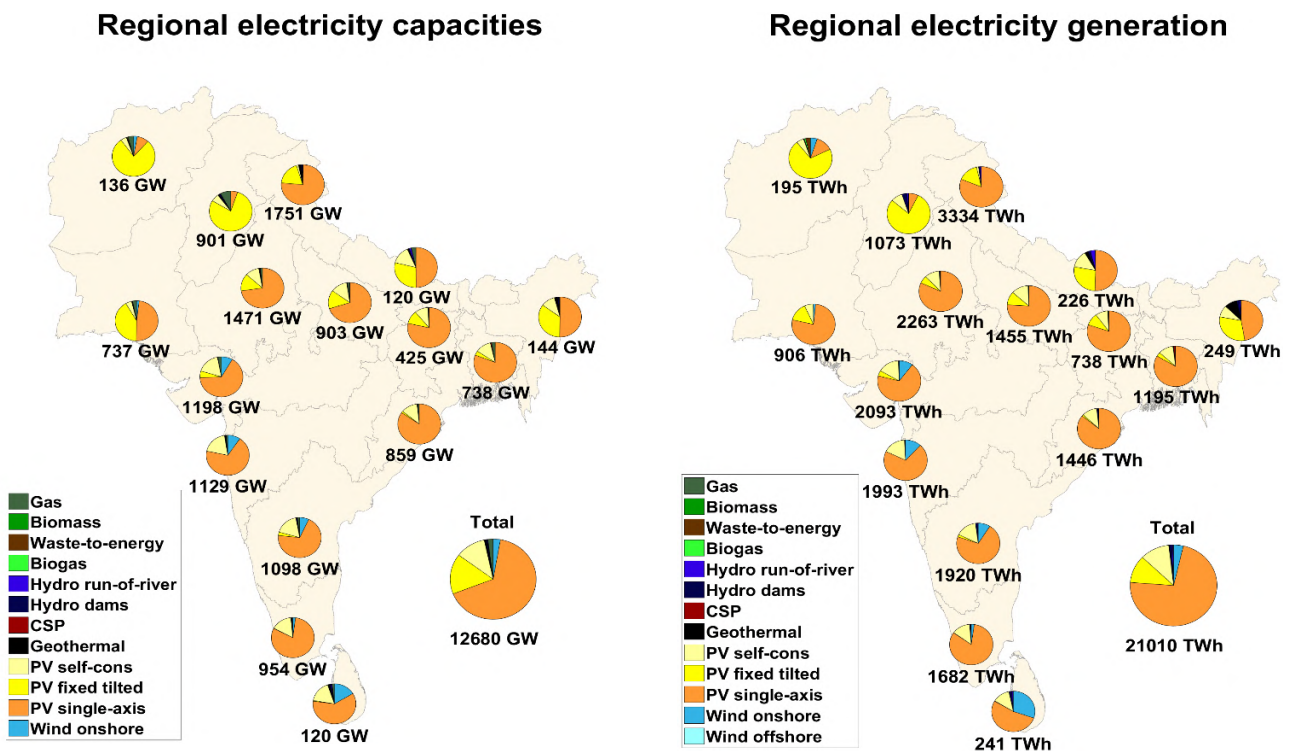

Figure 3.6-25: SAARC – Regional electricity generation capacities (left) and electricity generation (right) in 2050.

Solar PV capacities are well distributed across the different regions of SAARC and achieve a total installed capacity base of almost 11,910 GW in 2050. Moreover, there are capacities across the regions and countries with good solar conditions throughout the year, as shown in Figure 3.6-26.

Whereas, wind energy capacities achieve a total installed capacity base of nearly 345 GW in 2050 and are predominantly in the southern and western regions of south Asia, which have some wind potential. This can be observed in Figure 3.6-26.

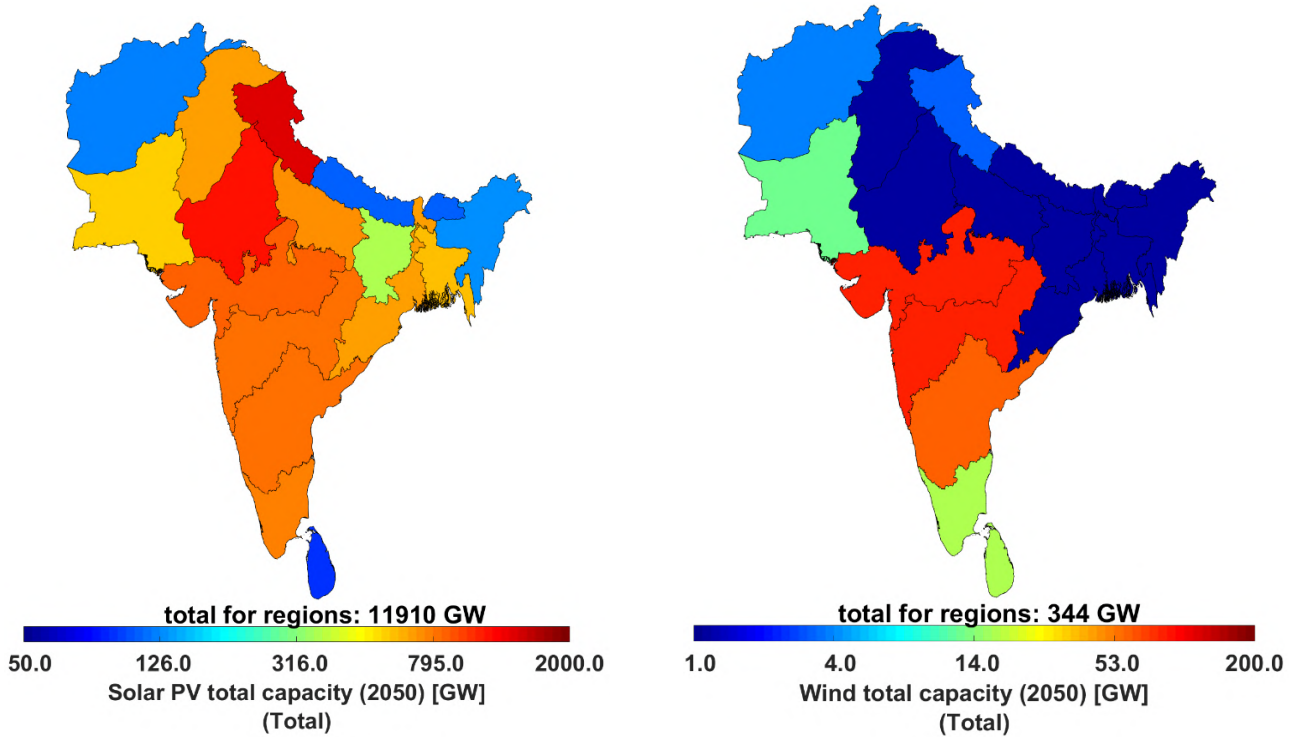

Figure 3.6-26: SAARC – Regional variation of electricity generation capacities of solar PV (top) and wind energy (bottom) in 2050.

The electricity generation across the power, heat, transport, and desalination sectors of SAARC are predominantly from PV and wind in 2050, evenly distributed across the regions as shown in Figure 3.6-27. Solar PV, which supplies an average of 94.6% of electricity generation across SAARC, is more common across all the regions. While wind

energy, which contributes an average of just 3.6% of electricity generation across SAARC, is mainly found in the southern regions of India-West, India-Central West, India-Central South and Sri Lanka. Overall, solar PV and wind generate most of the electricity needed across SAARC by 2050, which is around 98.2% of total electricity generation.

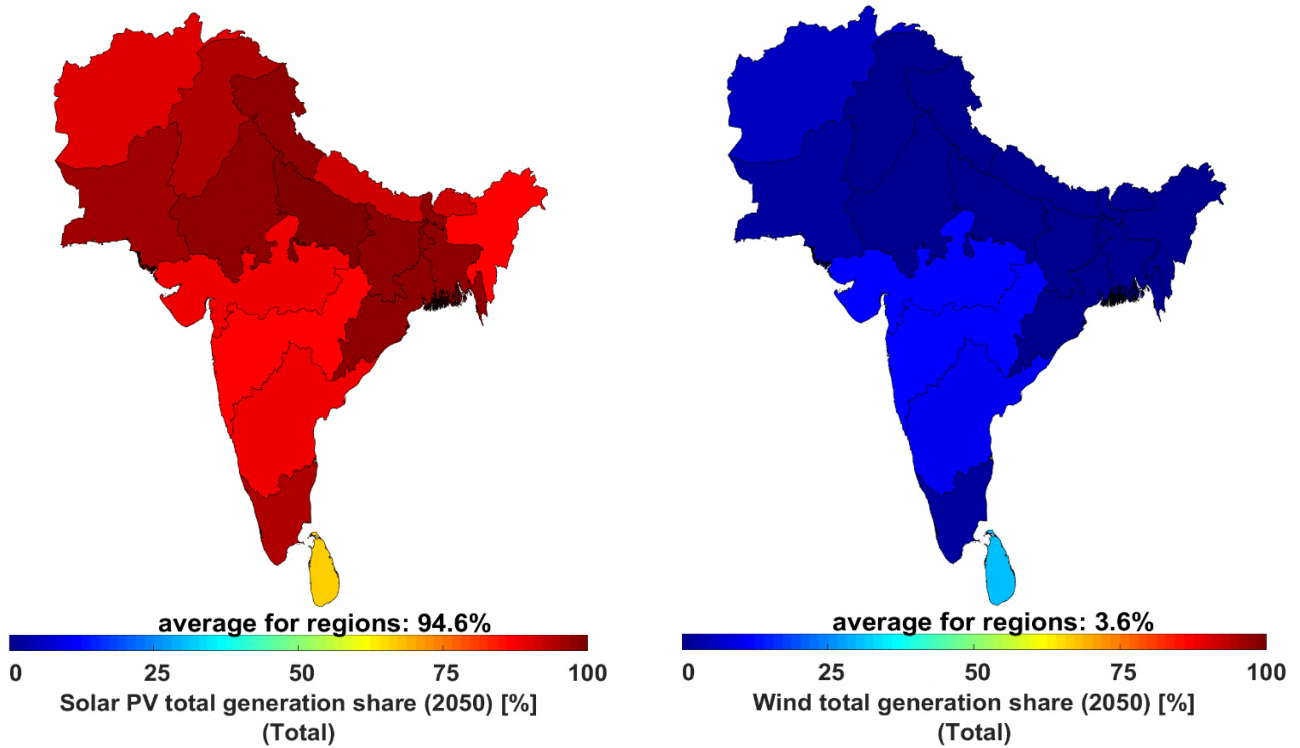

Figure 3.6-27: SAARC – Regional variation of electricity generation shares of solar PV (left) and wind energy (right) in 2050.

Utility-scale and prosumer batteries contribute a major share of electricity storage capacities, with some shares of A-CAES by 2050, as shown in Figure 3.6-28. Storage capacities are much higher in the northern and western parts of SAARC, to complement higher shares of installed solar PV

capacities, compared to the southern regions. Batteries, both prosumers and utility-scale, deliver the largest shares of output by 2050, as shown in Figure 3.6-28. A-CAES contributes complementary shares of electricity storage output through the transition, across the different regions of SAARC.

Regional electricity storage capacities

Regional electricity storage annual generation

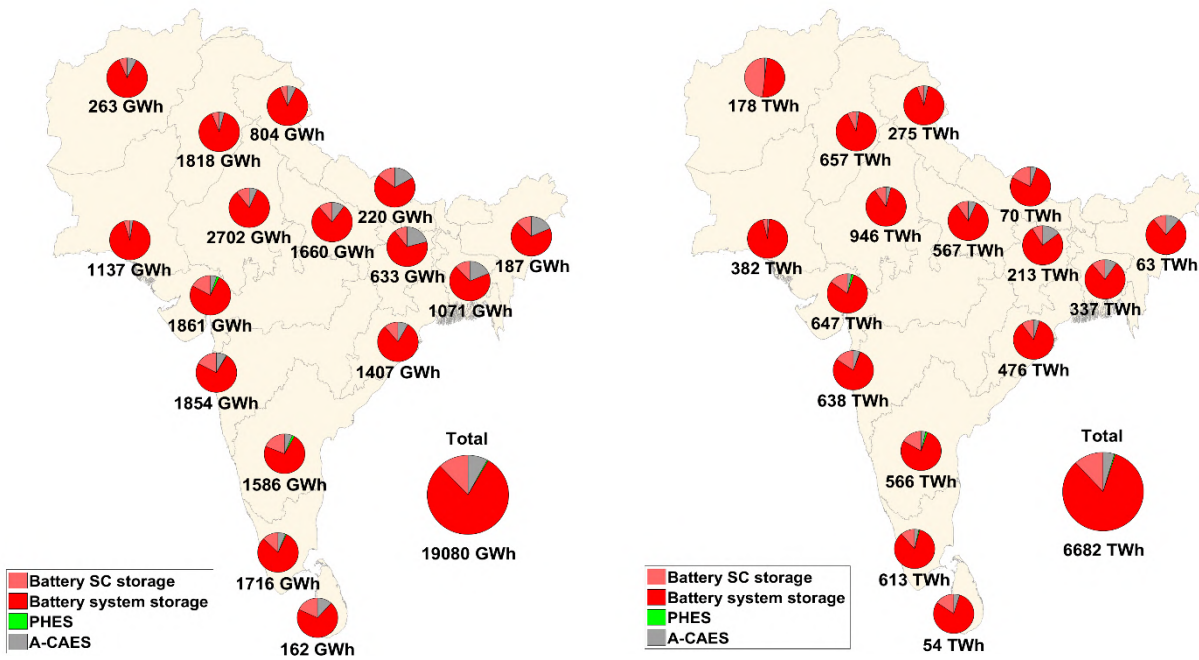

Figure 3.6-28: SAARC – Regional electricity storage capacities (left) and electricity storage annual throughput (right) in 2050.

The storage output across the power, heat, transport, and desalination sectors of SAARC is predominantly from batteries (both utility-scale and prosumers) and some synthetic natural gas supply in 2050, as shown in Figure 3.6-29. Batteries, which supply an average of 32.4% of the storage output across SAARC, are more common in the northern

and western regions of SAARC. Synthetic natural gas, which supplies an average of 0.3% of the total electricity demand across SAARC, is spread across the different regions. This is complemented with a supply share of storage from biomethane of less than 0.1% in 2050 across SAARC.

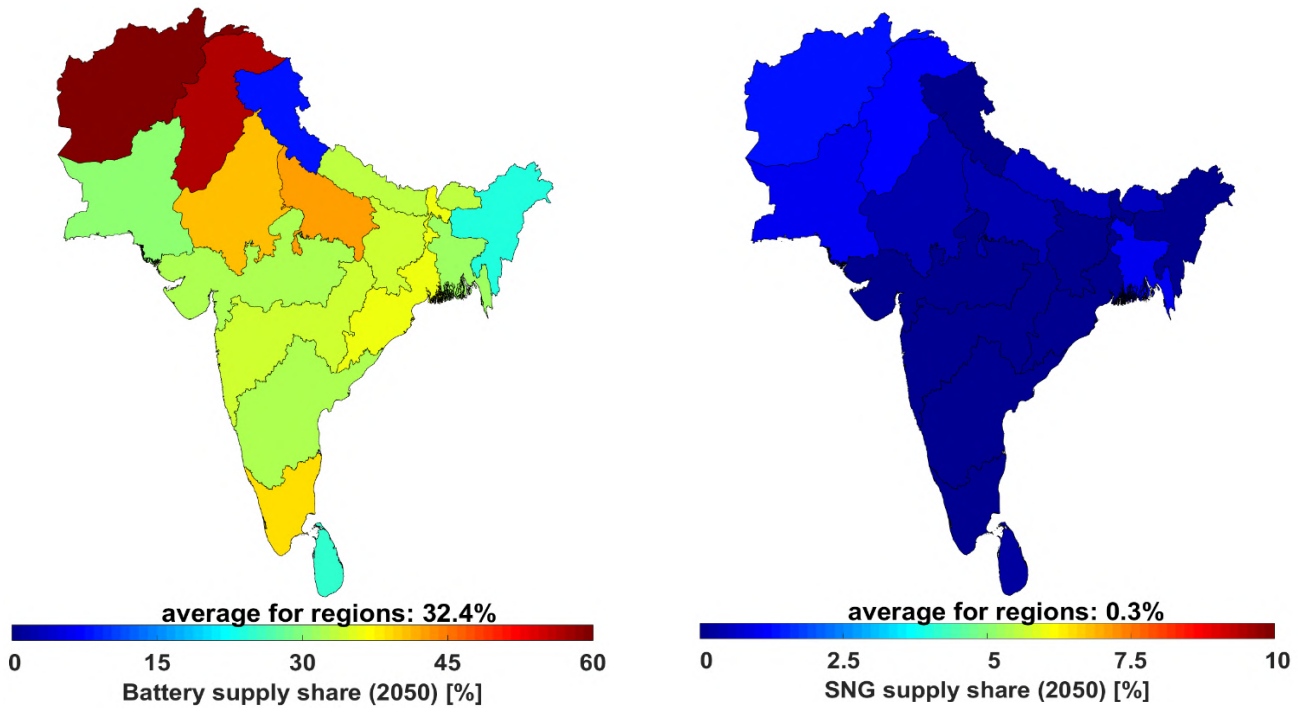

Figure 3.6-29: SAARC – Regional variation of storage supply shares of batteries (left) and synthetic natural gas (right) in 2050.

Greenhouse Gas Emissions

The results of the energy transition towards a 100% renewable energy system indicate a sharp decline in GHG emissions until 2050, reaching zero GHG emissions by 2050 across the power, heat, transport, and desalination sectors in SAARC as shown in Figure 3.6-30. The power sector

undergoes a deep decarbonisation by 2030, whereas for the heat and transport sectors this occurs mostly between 2030 and 2050. Moreover, the remaining cumulative GHG emissions comprise around 49 GtCO_{2eq} from 2018 to 2050. Therefore, the energy transition pathway for SAARC is in adherence to the ambitious Paris Agreement target of 1.5°C.

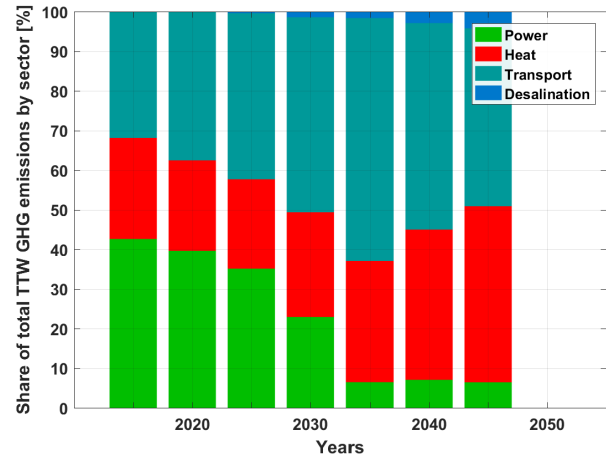
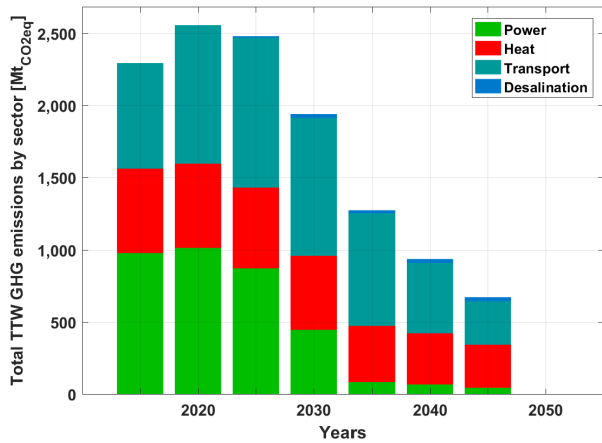

Figure 3.6-30: SAARC – Sector-wise GHG emissions (left) and the share of GHG emissions of different sectors (right) during the energy transition from 2015 to 2050. Tank to Wheel (TTW) considers GHG emissions from readily available fuels and does not consider GHG emissions from the upstream production and delivery of fuels.

GHG emissions from the power sector decline through the transition from around 1,000 MtCO₂ eq./a in 2020 to zero by 2050 as shown in Figure 3.6-31. Similarly, GHG emissions from the heat sector decline through the transition from over 600 MtCO₂ eq./a in 2015 to zero by 2050 as shown in Figure 3.6-31.

around 1,100 MtCO₂ eq./a in 2015 to zero by 2050, as shown in Figure 3.6-32. Similarly, GHG emissions from the desalination sector, which are much lower than those of other sectors, increase through the transition from around 3 MtCO₂ eq./a in 2015 to about 28 MtCO₂ eq./a in 2045 and then drop to zero by 2050, also visible in Figure 3.6-32.

GHG emissions from the transport sector after an initial increase, decline through the transition from

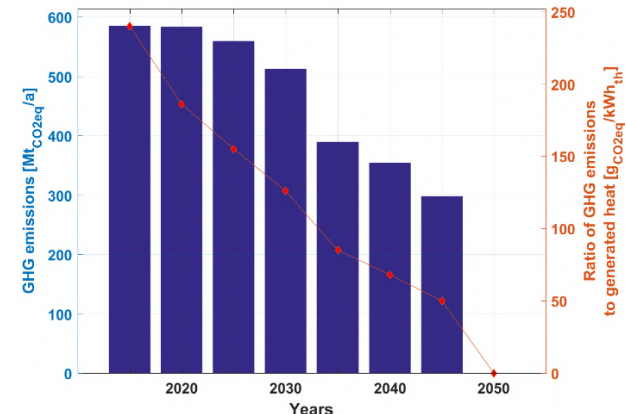
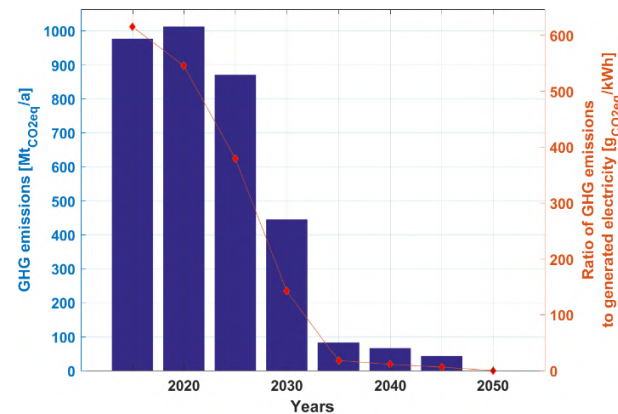

Figure 3.6-31: SAARC – GHG emissions in the power sector (left) and GHG emissions in the heat sector (right) during the energy transition from 2015 to 2050.

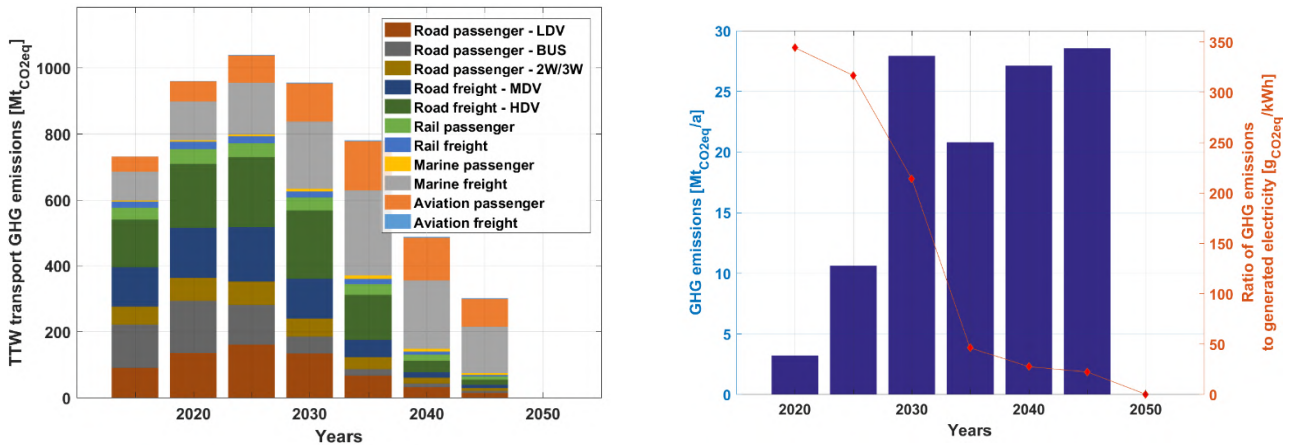

Figure 3.6-32: SAARC – GHG emissions in the transport sector (left) and GHG emissions in the desalination sector (right) during the energy transition from 2015 to 2050. Tank to Wheel (TTW) considers GHG emissions from readily available fuels and does not consider GHG emissions from the upstream production and delivery of fuels.

Jobs in the Power Sector across SAARC

Solar PV with 4.18 million jobs and battery storage with 894 thousand jobs emerge as the major job creators across the region by 2050 as shown in Figure 3.6-33. Wind energy with 504 thousand in 2030, hydropower with 297 thousand jobs in 2020 and bioenergy with 523 thousand jobs in 2025 create a fair share of the jobs in the initial periods of the transition. Beyond 2030, the shares decrease and stabilise until 2050. The storage sector led by batteries create a fair share of the jobs in 2030 with 23% of total jobs and continue to contribute until

2050 with a steady share. Whereas, the jobs associated primarily with coal and gas power generation diminish rapidly. The total number of direct energy jobs increase rapidly from over 4.2 million in 2015 to just over 7 million by 2030, thereafter stabilising around 5.8 million by 2050. This drop is primarily due to the rapid ramping up of power capacity installations to ensure energy access for the vast number of un-electrified people in this region up to 2030. Beyond that, capacity addition would be at a slower rate to fulfil economic development.

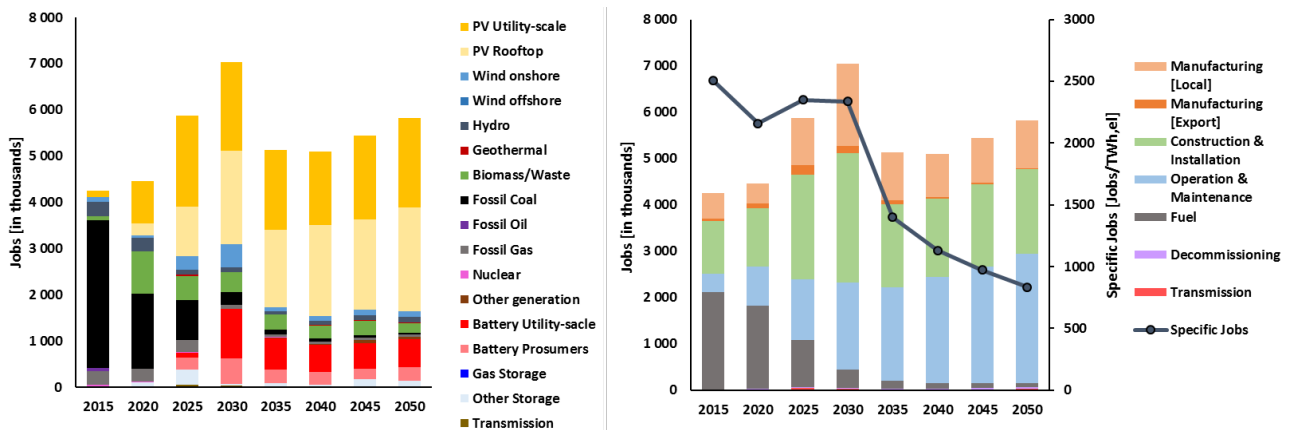

Figure 3.6-33: SAARC – Jobs created by various power generation and storage technologies (left) and jobs created based on different categories with the development of electricity demand specific jobs (right) during the energy transition from 2015 to 2050.

With a rapid ramp up of installations up to 2030, the majority of jobs is created in the construction and installation of power generation technologies with 40% of total jobs in 2030. Manufacturing jobs increase in share from 2020 to 2030, with minor shares of exports (domestic manufacturing creates 25% and exports creates 2% of total jobs in 2030). The SAARC region is an importer as well as an exporter of power generation technologies. Beyond 2030, as production capabilities in other importing regions build up, a relatively low share of manufacturing jobs is observed until 2050 (around 18% of total jobs). The share of fuel related jobs

continues to diminish through the transition period, as conventional power plants are replaced by renewable and storage technologies (from 49% of total jobs in 2015 to just 1% of total jobs by 2050). By contrast, the share of operation and maintenance jobs continues to grow through the transition period with 48% of total jobs by 2050. The electricity demand specific jobs decrease steadily from 2508 jobs/TWh_{el} in 2015 to 2335 jobs/TWh_{el} in 2030 with the rapid ramp up in renewable energy installations. Beyond 2030, it declines rapidly to around 834 jobs/TWh_{el} by 2050, as shown in Figure 3.6-33.

3.7. Northeast Asia

The Northeast Asian region is comprised of the fastest growing economies, with around a 25% share of global GDP ⁷². Population in Northeast Asia is 1581 million in 2015 representing a share of 22% in world population, which is estimated to be 16% in 2050. With rapid industrialisation, unprecedented economic progress and a soaring appetite for energy, states across the region are stepping up their efforts to secure the energy supplies needed to sustain this rapid expansion. The energy sector in Northeast Asia is vital to its overall development. Therefore, effective energy planning, optimal design, wise utilisation of all available renewable energy resources and

maximum synergy between various regions of the Northeast Asian countries will foster sustainable development in the region. The detailed results for the energy transition across Northeast Asia are available in a supplementary data file, the link for the file can be found in the Appendix.

Penetration of renewables is not just a matter of replacing hydrocarbons with zero-carbon sources of energy supply – it also represents a significant change in resource efficiency. This is illustrated by the overall electrification across the power, heat, transport, and desalination sectors as shown in Figure 3.7-1.

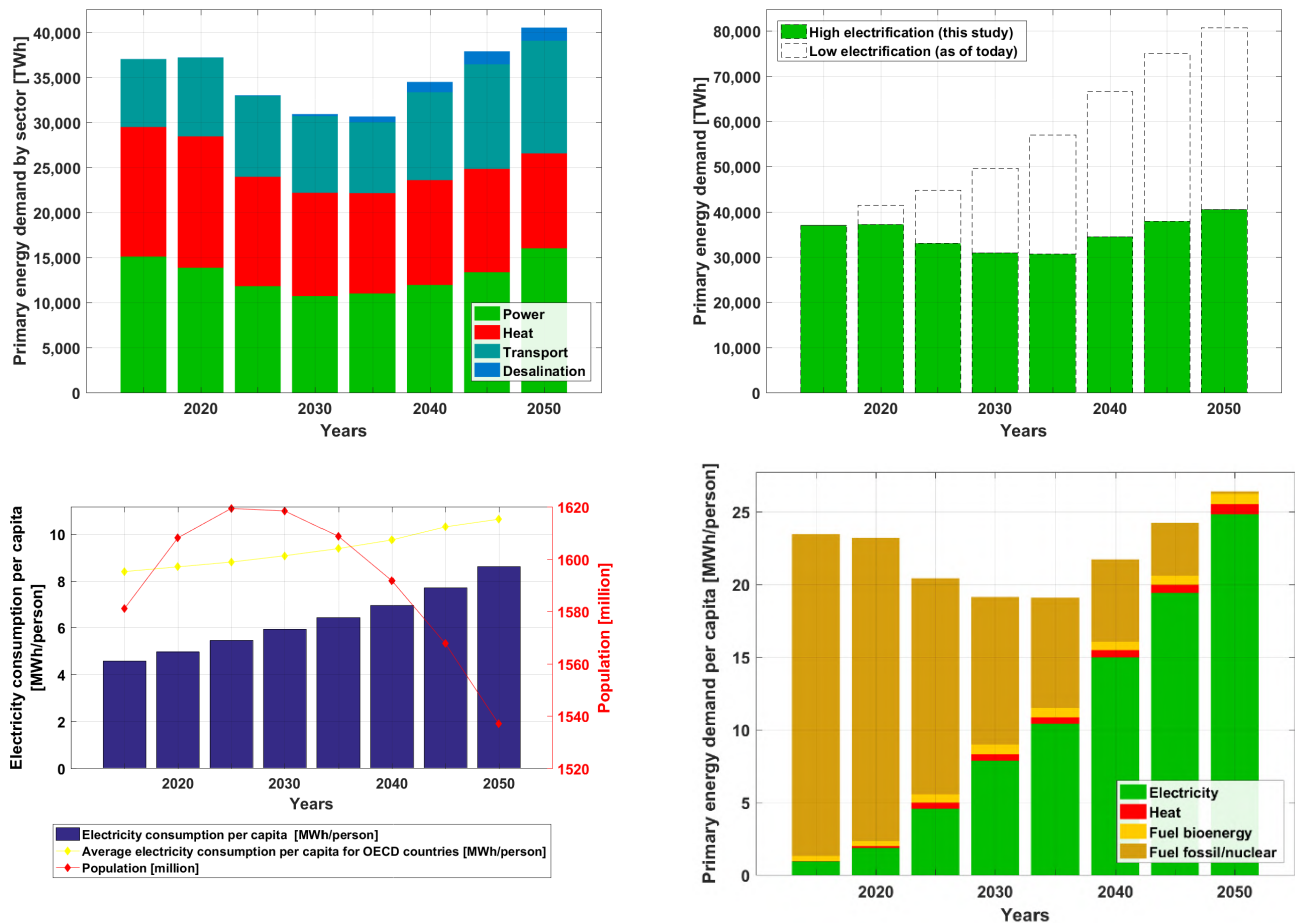

Figure 3.7-1: Northeast Asia – Primary energy demand sector-wise (top left), efficiency gain in primary energy demand (top right), electricity consumption per capita with population (bottom left) and primary energy demand per capita (bottom right) during the energy transition from 2015 to 2050.

The primary energy demand assuming high electrification, which is the basis for this study, decreases from about 37,000 TWh in 2015 to around 30,000 TWh by 2035 and increases up to over 40,000 TWh by 2050. On the contrary, with low shares of electrification resulting from the adoption of current practices until 2050, the primary energy demand would reach over 80,000 TWh by 2050. The massive gain in energy efficiency is primarily due to a high level of electrification of more than 92% resulting in the reduction of around 40,000 TWh by 2050, in comparison to the continuation of current practices with low shares of electrification. The population across northeast Asia is expected to shrink slightly from 1581 to 1537 million by 2050. Correspondingly, the average per capita energy demand decreases from around 24 MWh/person in 2015 to 19 MWh/person by 2035 and increases up to nearly 27 MWh/person by 2050. However, a higher demand for industrial process heat as well as demand for desalination reduces the overall gains and contributes to an increase in energy demand in the later years of the

transition, from 2035 to 2050. Additionally, a substantial demand from fuel conversion technologies arises beyond 2040, in producing renewable-based fuels for the transport sector across Northeast Asia.

Energy Supply

The electricity generation capacity across Northeast Asia satisfies demand from all energy sectors including power, heat, transport and desalination. The total installed capacity grows massively from over 1800 GW in 2015 to around 22,500 GW by 2050 as shown in Figure 3.7-2. In the initial period of the transition, a larger share of wind capacities are installed up to 2030, but in the later part of the transition solar PV dominates the shares of installed capacities reaching almost 17,770 GW by 2050. On the other hand, the shares of fossil fuels and nuclear decline through the transition to zero by 2050. Some shares of gas remain, but the fuel switches from fossil based gas to synthetic natural gas produced with renewable electricity and biomethane.

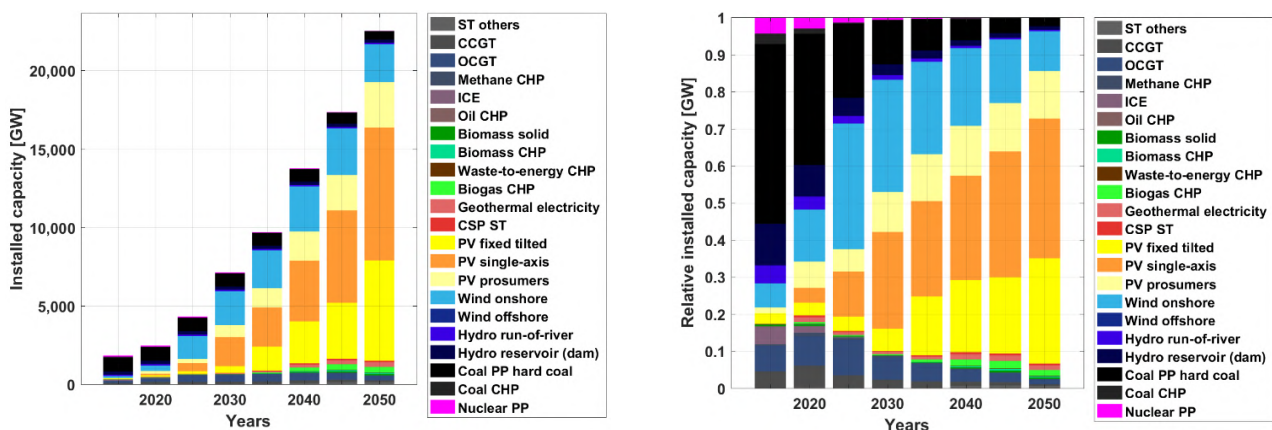

Figure 3.7-2: Northeast Asia – Technology-wise installed capacities (left) and technology-wise shares of installed capacities (right) during the energy transition from 2015 to 2050.

Electricity generation from the various technologies to cover the demand of power, heat, transport, and desalination sectors is shown in Figure 3.7-3. Solar PV supply increases through the transition from 29% in 2030 to about 72% by 2050, becoming the lowest cost energy source. Wind energy increases to 49% by 2030 and the shares decline to around 22% by 2050. Also, complemented by some shares of hydropower through the transition. In the heat sector, heat pumps play a significant role through the transition with a share of nearly 44% of heat

generation by 2050 on both the district and individual levels, as indicated in Figure 3.7-3. On the other hand, coal-based heating decreases through the transition from over 64% in 2015, to zero by 2050. Additionally, fossil fuel-based heating decreases through the transition period, as coal-based CHP and DH is replaced by electric heating, waste-to-energy CHP, biomass-based DH, and IH. Additionally, some shares of solar thermal and non-fossil gas based heating contribute through the transition.

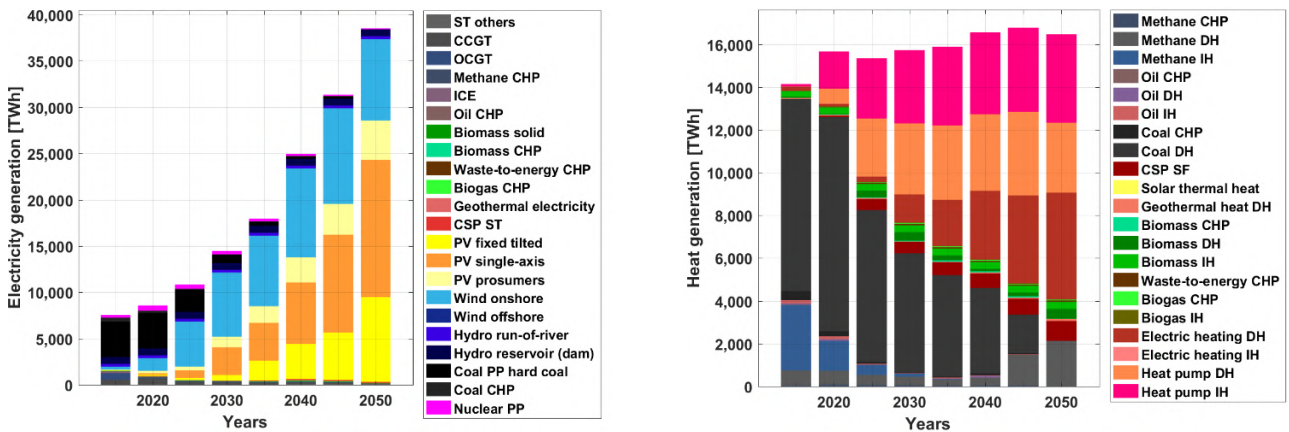

Figure 3.7-3: Northeast Asia – Technology-wise electricity generation (left) and technology-wise heat generation (right) during the energy transition from 2015 to 2050.

Energy Storage

Energy storage technologies play a critical role in enabling a secure energy supply throughout northeast Asia, fully based on renewable energy across different sectors. As highlighted in Figure 3.7-4, storage output covers more than 8,100 TWh_{el} of total electricity demand in 2050. The ratio of electricity demand covered by energy storage to electricity generation increases significantly to over 15% by 2035 and thereafter increase steadily up to

around 23% by 2050. Additionally, about 6% is covered by heat storage conversion to electricity by 2050. Batteries emerge as the most relevant electricity storage technology contributing about 91% of the total electricity storage output by 2050. Additionally, a significant share of gas storage is installed to provide seasonal storage primarily during the cold winter season across some of the regions of northeast Asia.

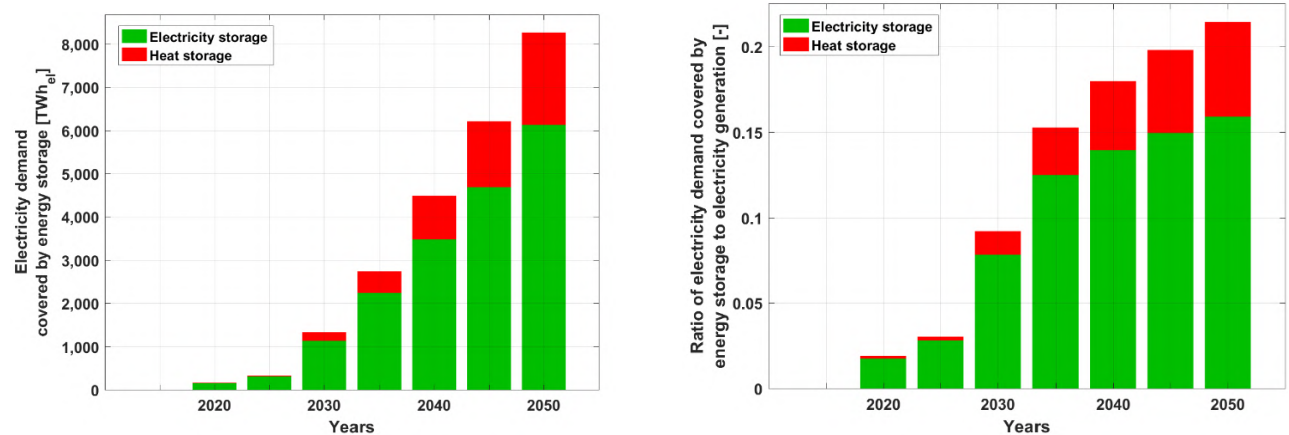

Figure 3.7-4: Northeast Asia – Electricity demand covered by energy storage (left) and ratio of electricity demand covered by different forms of energy storage (right) during the energy transition from 2015 to 2050.

Similarly, heat storage plays a vital role in ensuring heat demand is covered across all the sectors. As indicated in Figure 3.7-5, storage output covers more than 6,000 TWh_{th} of the total heat demand in 2050 and heat storage technologies are crucial to meet this demand. The ratio of heat demand covered by energy storage to heat generation increases substantially to over 33% by 2050, also shown in Figure 3.7-5. Thermal energy storage

(TES) emerges as the most relevant heat storage technology with around 64% of heat storage output by 2050. Furthermore, power-to-gas (PtG) contributes around 36% of heat storage output in 2050. As fossil fuel usage for heat generation is completely eliminated in the final five-year period from 2045-2050, there is an increase in heat storage utilisation.

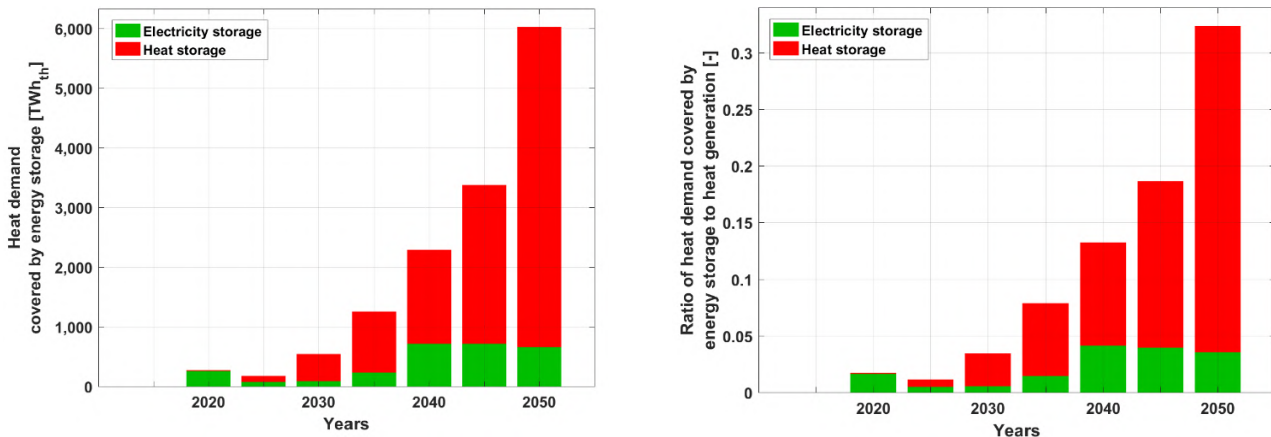

Figure 3.7-5: Northeast Asia – Heat demand covered by energy storage (left) and the ratio of heat demand covered by different forms of energy storage (right) during the energy transition from 2015 to 2050.

Costs and Investments

The total annual system costs are in the range of 1,350-2,200 b€ through the transition period and are well distributed across the major sectors of power, heat, and transport, as desalination demand in northeast Asia is relatively smaller and arises 2035 onwards. As indicated by Figure 3.7-6, power, heat, and transport costs increase from around 1,350 b€ in 2015 to around 2,100 b€ by 2050, with

stable shares through the transition. In addition, as indicated in Figure 3.7-6 CAPEX increases through the transition, as fuel costs decline. The steady increase in CAPEX-related energy system costs indicate that fossil fuels imports and the respective negative impacts on trade balances will fade out through the transition. In addition, lower fossil fuels import dependency will lead to higher levels of energy security across northeast Asia.

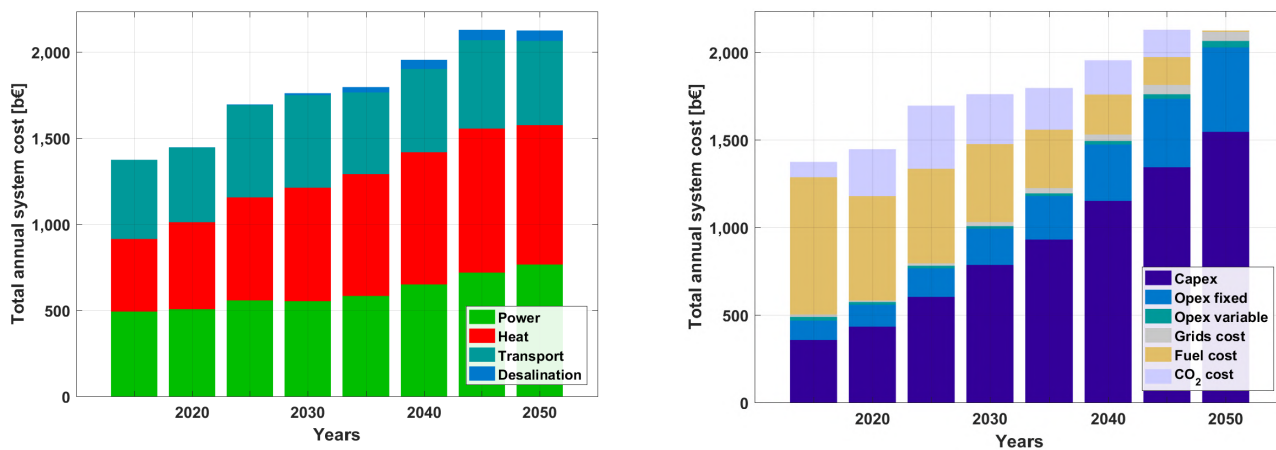

Figure 3.7-6: Northeast Asia – Annual system costs, sector-wise (left) and functionality-wise (right) during the energy transition from 2015 to 2050.

As increasing shares of power generation capacities are added across Northeast Asia, renewable energy sources become the least costing power generation sources⁶⁶. As indicated in Figure 3.7-7, levelised cost of energy remains around €50-60/MWh and is increasingly dominated by capital costs as fuel costs continue to decline through the transition period, which could mean increased self-

reliance in terms of energy for northeast Asia by 2050 as mentioned earlier. Capital costs are well spread across a range of technologies with major investments for PV, wind energy, batteries, heat pumps, and synthetic fuel conversion up to 2050, as shown in Figure 3.7-7. The cumulative investments are about 19,200 b€ through the transition from 2016-2050.

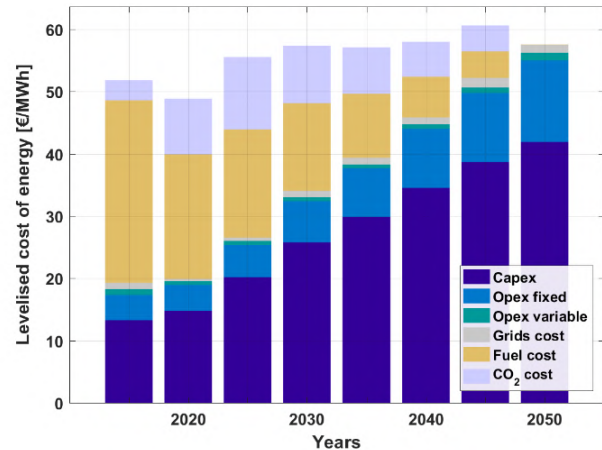
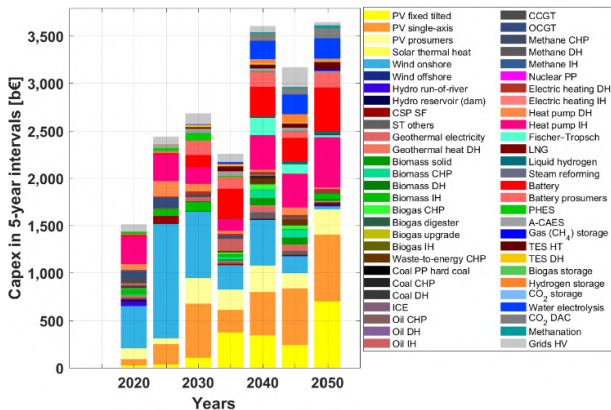

Figure 3.7-7: Northeast Asia – Capital costs for five-year intervals (left) and levelised cost of energy (right) during the energy transition from 2015 to 2050.

Outlook across Sectors

Different trends in the power, heat, transport, and desalination sectors across Northeast Asia emerge through the transition. As the sectors transition towards having higher shares of renewable energy, different technologies have vital roles in ensuring the stability of the energy system. A closer look at the individual sectors provides further insights into the energy transition across Northeast Asia towards 100% renewable energy.

Power and Heat

The total installed power generation capacity increases from nearly 2,000 GW in 2015 to over 15,600 GW by 2050, as shown in Figure 3.7-8.

Across the power sector, solar PV with almost 11,640 GW and wind with around 1,570 GW constitute the majority of installed capacities by 2050. Complemented by some shares of hydropower. In the heat sector, heat pumps, electric heating, solar thermal and biomass-based heating constitute the majority of installed capacity by 2050, also shown in Figure 3.7-8. An increase in the installed capacities of heat pumps and electric heating occurs in the final five-year period leading up to 2050, as fossil fuels are completely eliminated from the Northeast Asian energy system.

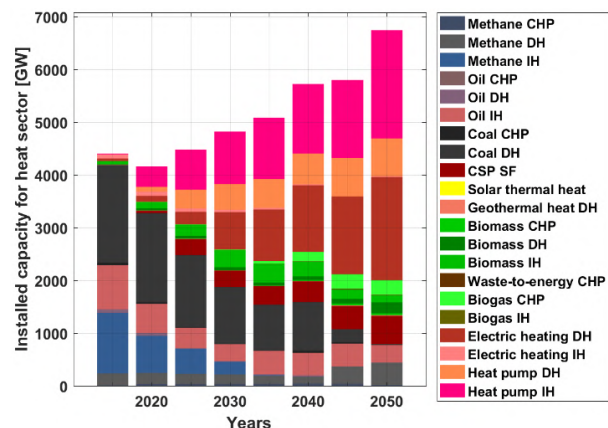
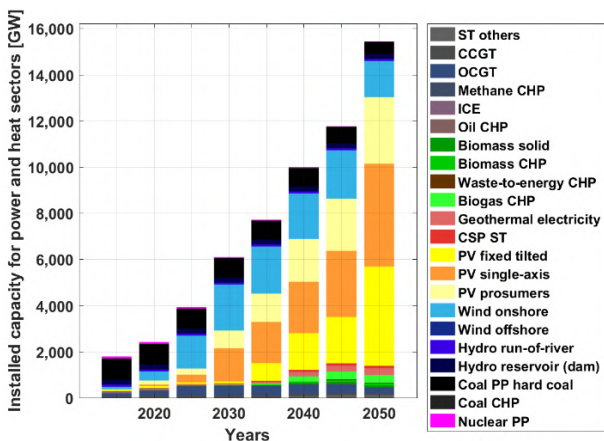

Figure 3.7-8: Northeast Asia – Technology-wise installed capacities for power (left) and heat (right) during the energy transition from 2015 to 2050.

The transition across Northeast Asia results in a power and heat sector dominated by fossil fuel and nuclear in 2015 moving towards a solar PV and wind energy dominated sector by 2050, with some hydropower as shown in Figure 3.7-9. The primary electricity generation increases from around 7,500 TWh in 2015 to around 24,500 TWh by 2050, which

is primarily from PV and wind. Heat generation increases marginally from around 14,000 TWh in 2015 to around 16,100 TWh by 2050, which is predominantly from heat pumps and electric heating with some solar thermal and biomass-based heating, also shown in Figure 3.7-9.

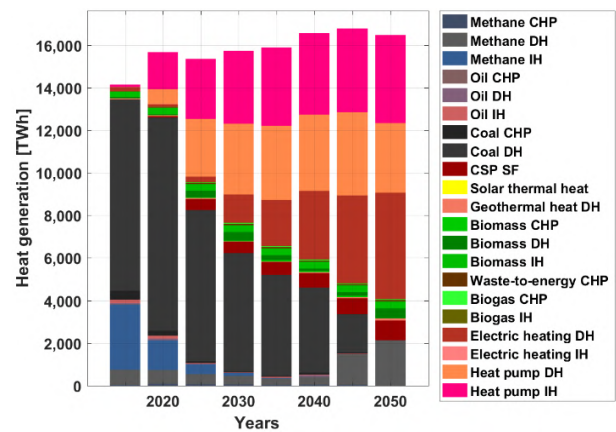
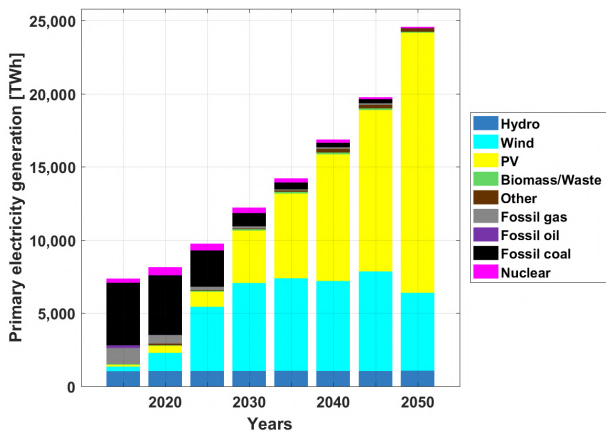

Figure 3.7-9: Northeast Asia – Primary electricity generation (left) and technology-wise heat generation (right) during the energy transition from 2015 to 2050.

The installed electricity storage capacity increases from just around 0.5 TWh in 2015 to over 17 TWh by 2050, as shown in Figure 3.7-10. Utility-scale and prosumer batteries with some shares of PHEs and A-CAES are installed through the transition. The installed capacities of A-CAES are also a consequence of the modelling approach, which prioritises full domestic energy supply for all

northeast Asian regions. The installed heat storage capacity increases gradually until 2045 to around 21 TWh, but in the final five-year period up to 2050, a massive capacity of gas storage of nearly 90 TWh is added, as shown in Figure 3.7-10. This substantial capacity addition is mainly to provide seasonal storage across northeast Asia covering the heat demand in the absence of fossil fuels.

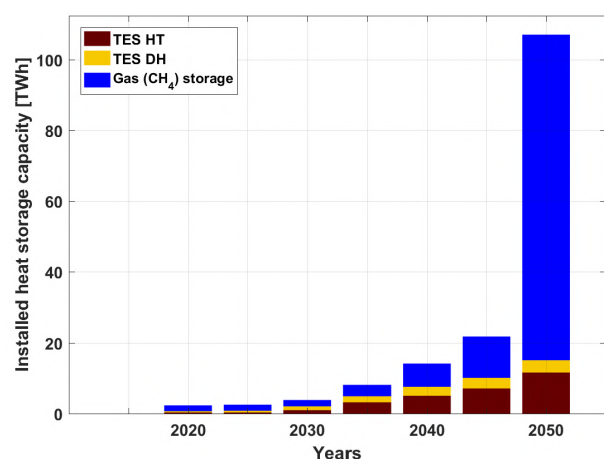
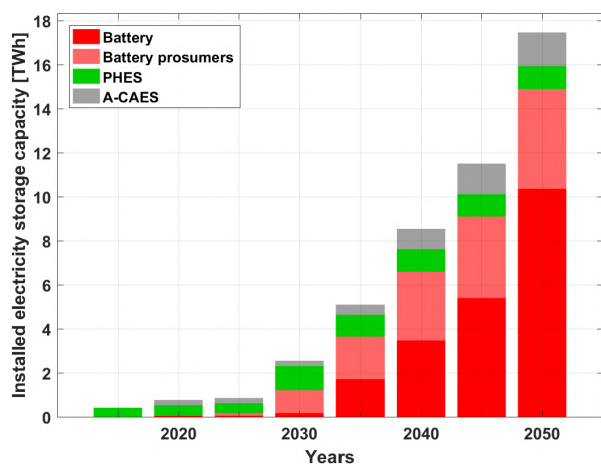

Figure 3.7-10: Northeast Asia – Installed electricity storage capacities (left) and heat storage capacities (right) during the energy transition from 2015 to 2050.

Utility-scale and prosumer batteries contribute a major share of electricity storage output with nearly 91% by 2050, as highlighted by Figure 3.7-11. In addition, PHEs and A-CAES contribute some shares through the transition. TES emerges as the most relevant heat storage technology with a

majority share of heat storage output from through the transition, with 64% by 2050 also seen in Figure 3.7-11. Gas storage contributes around 36% of the heat storage output in 2050 covering predominantly seasonal demand, previously covered by fossil fuels.

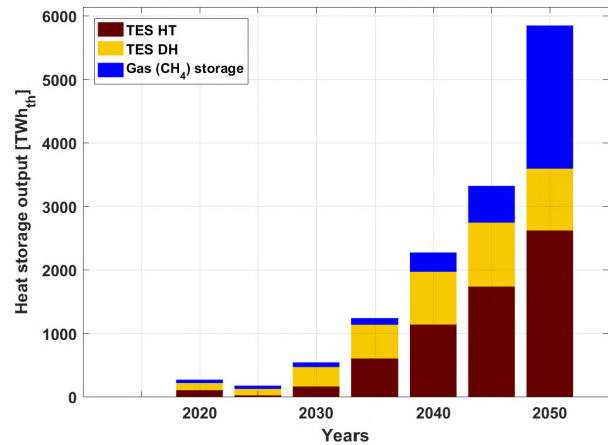
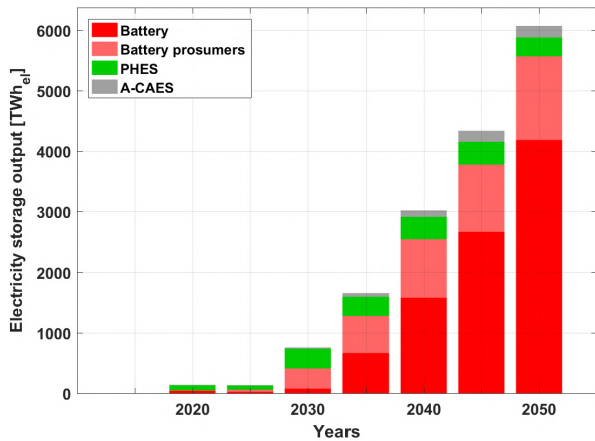

Figure 3.7-11: Northeast Asia – Electricity storage output (left) and heat storage output (right) during the energy transition from 2015 to 2050.

LCOE of the power sector decreases steadily from around 74 €/MWh in 2015 to around 60 €/MWh by 2050, as shown in Figure 3.7-12. LCOE is predominantly comprised of CAPEX as fuel costs decline through the transition. Whereas, LCOH of the heat sector increases through the transition from around 34 €/MWh in 2015 to around 54

€/MWh by 2050, as shown in Figure 3.7-12. LCOH is predominantly comprised of CAPEX as fuel costs decline through the transition. Despite a substantial increase in heat demand across northeast Asia, mainly driven by industrial process heat, the LCOH increase is quite steady up to 2050.

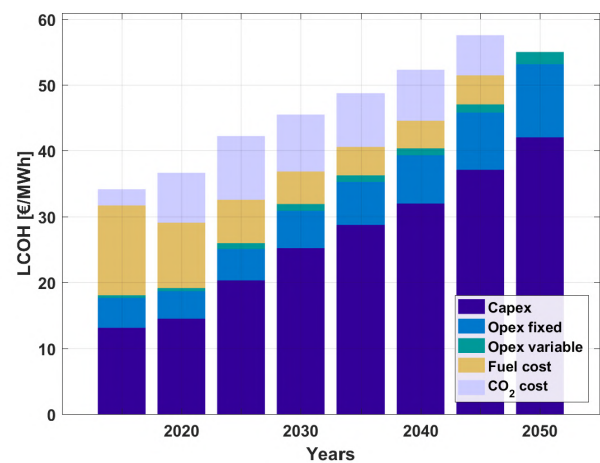
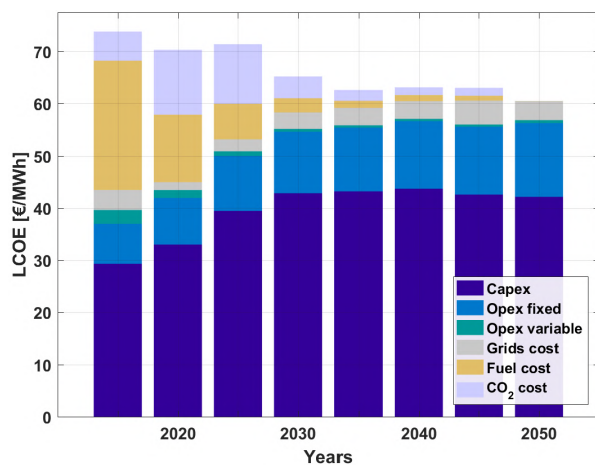

Figure 3.7-12: Northeast Asia – Levelised cost of electricity (left) and levelised cost of heat (right) during the energy transition from 2015 to 2050.

Investments are well spread across a range of power generation technologies with the majority share in wind energy up to 2030, beyond which solar PV dominates investments up to 2050, as shown in Figure 3.7-13. Investments in the heat sector are mainly in heat pumps and some shares in

biomass heating up to 2050, also shown in Figure 3.7-13. The steep increase in heat pump investments in the final five-year period until 2050 is mainly to cover the heat demand in the absence of fossil fuels as well as the lower costs of heat pumps by 2050.

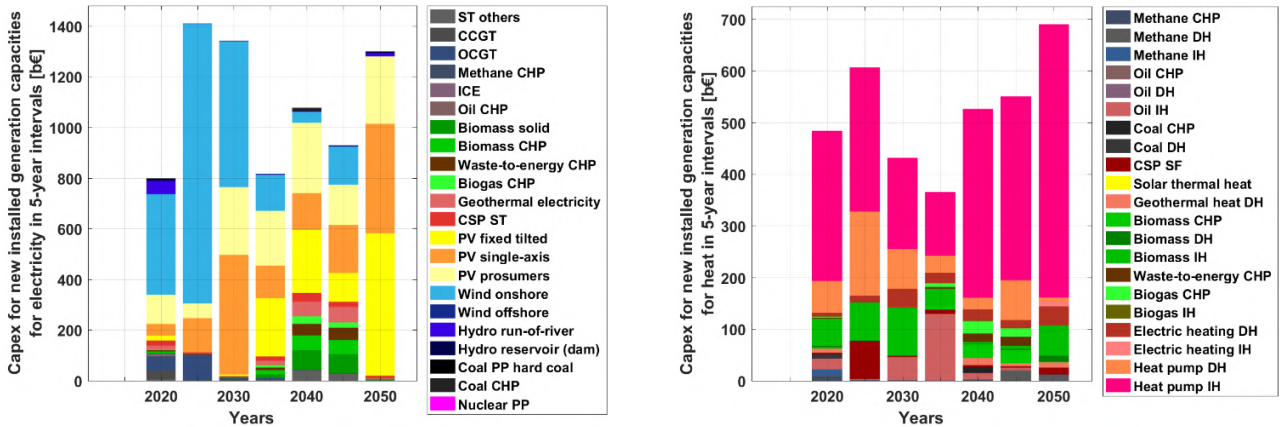

Figure 3.7-13: Northeast Asia – Capital costs of installed generation capacities in five-year intervals for electricity (left) and heat (right) during the energy transition from 2015 to 2050.

Transport

The final energy demand of the transport sector across Northeast Asia is almost the same as the energy demand from the power sector at around 7,300 TWh in 2015. However, this demand increases through the transition to around 8,700 TWh by 2025 and further on declines back to around 7,200 TWh by 2035, beyond which it increases steadily up to about 8,000 TWh by 2050 as shown in Figure 3.7-14. Despite tremendous growth in transport activities, the demand rise is quite low mainly due to the efficiency gains brought about by electrification of the sector as shown in Figure 3.7-14. On the contrary, fossil fuels

consumption in the transport sector across northeast Asia is seen to decline through the transition from about 97% in 2015 to zero by 2050. While, liquid fuels produced by renewable electricity contribute around 30% of final energy demand in 2050. In addition, hydrogen constitutes more than 22% of final energy demand in 2050. Sustainably produced biofuels contribute a minor share to enable a complete elimination of fossil fuel usage in the transport sector. Electrification of the transport sector creates an electricity demand of around 12,000 TWh_{el} by 2050. The massive demand for liquid fuels kicks in from 2040 onwards up until 2050, as indicated in Figure 3.7-14.

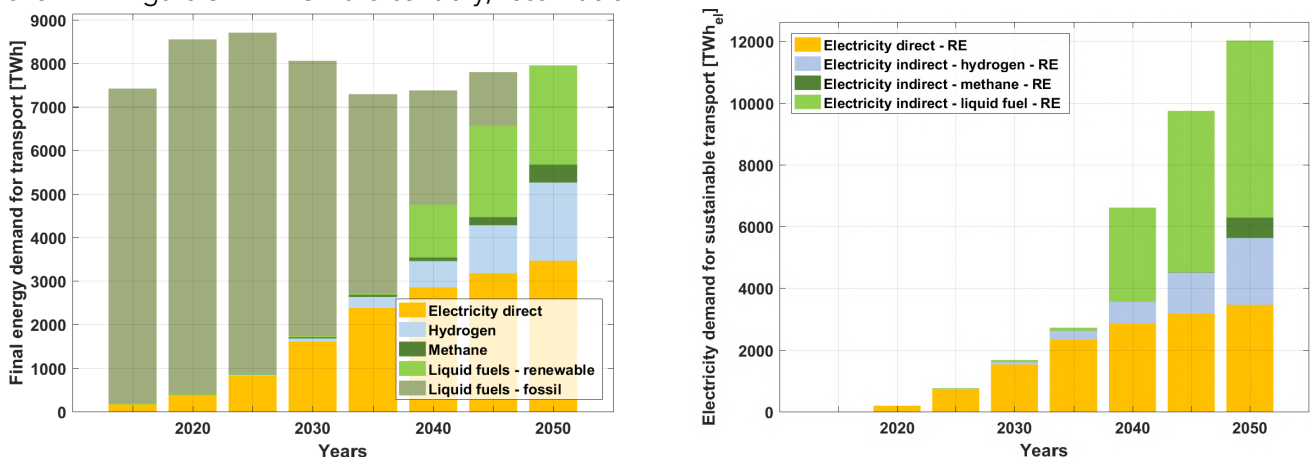

Figure 3.7-14: Northeast Asia – Final energy demand for transport (left) and electricity demand for sustainable transport (right) during the energy transition from 2015 to 2050.

Installed power generation capacity for the transport sector increases substantially through the transition to around 6,250 GW by 2050, as shown in Figure 3.7-15. Solar PV and wind form the majority shares of the power generation capacities for the transport sector, as they are the least

costing energy sources by 2050. Similarly, electricity generation increases substantially up to almost 12,500 TWh by 2050 as shown in Figure 3.7-15. Solar PV and wind energy generate all the electricity required to meet the demand of the transport sector in 2050.

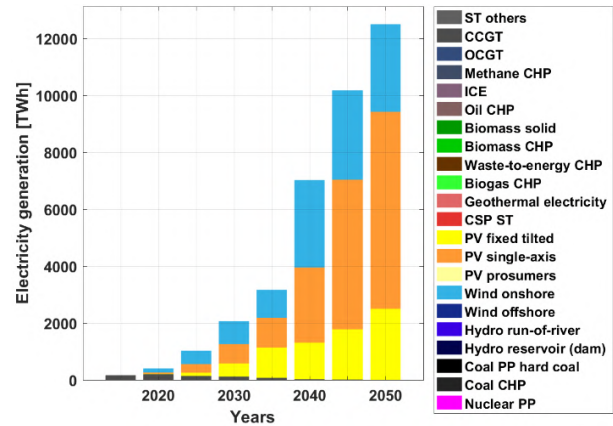
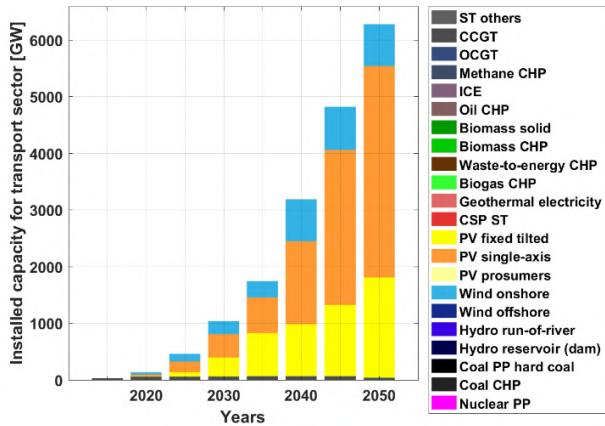

Figure 3.7-15: Northeast Asia – Transport sector installed power generation capacity (left) and electricity generation (right) during the energy transition from 2015 to 2050.

A critical aspect to complement the electrification of the transport sector is the installation of storage technologies. As seen in Figure 3.7-16, the installed capacities of electricity storage increase through the transition to around 5.1 TWh by 2050. The majority of installed capacities are utility-scale batteries and A-CAES with some shares of PHES. Similarly, electricity storage output increases through the transition to over 1,700 TWh_{el} by 2050

as shown in Figure 3.7-16. Utility-scale batteries play a vital role as they contribute a major portion of the output through the transition, with over 1,400 TWh_{el} by 2050. The relatively low electricity storage of less than 15% of generated electricity for the transport sector is enabled by the flexible operation of batteries, water electrolyser units, and hydrogen buffer storage for synthetic fuel production.

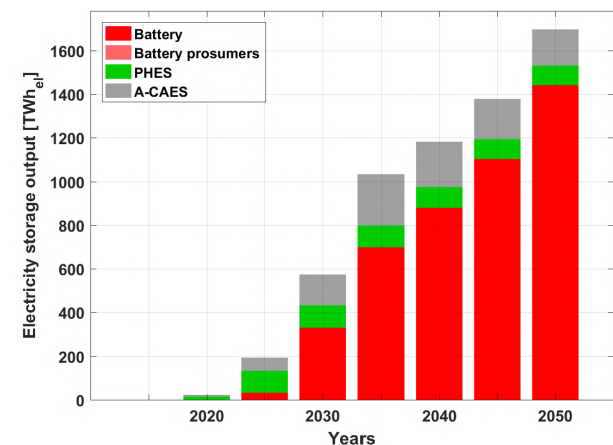
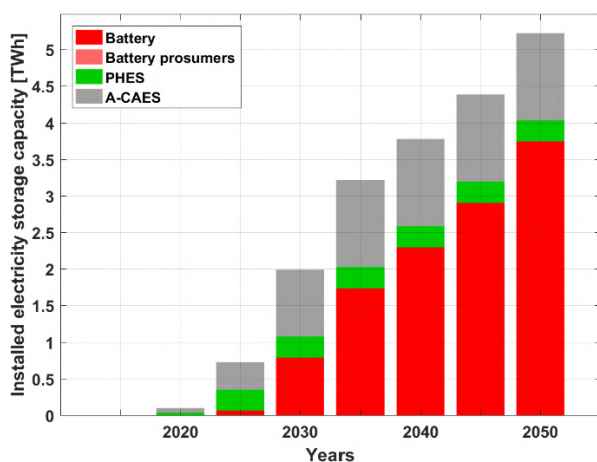

Figure 3.7-16: Northeast Asia – Transport sector installed electricity storage capacity (left) and electricity storage output (right) during the energy transition from 2015 to 2050.

An essential aspect in the transition of the transport sector towards higher levels of electrification completely based on renewable energy is the production of synthetic fuels, hydrogen and sustainable biofuels. As indicated in Figure 3.7-17, the installed capacities of fuel conversion technologies increase substantially from 2040 onwards to over 2,700 GW by 2050. Water electrolysis forms the majority share of fuel

conversion capacities through the transition. Additionally, heat is needed during the production of synthetic fuels, mainly for energy-efficient CO₂ direct air capture, and this is enabled by managing process heat, which is otherwise not useable. Heat utilisation is in the range of 1,550 TWh_{th} by 2050, which is comprised of excess heat and recovered heat, as shown in Figure 3.7-17.

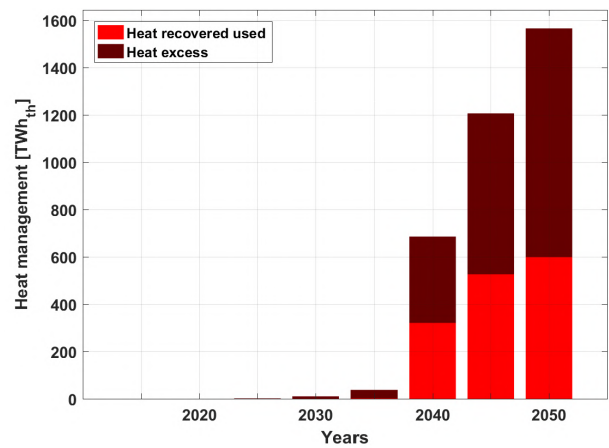
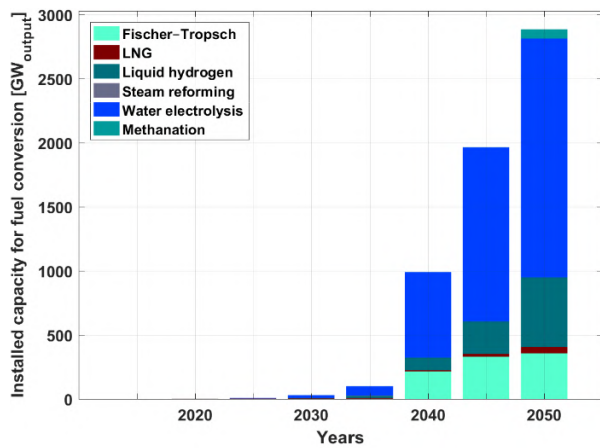

Figure 3.7-17: Northeast Asia – Transport sector installed capacity for fuel conversion (left) and heat management (right) during the energy transition from 2015 to 2050.

Similarly, gas storage is necessary in the production of synthetic fuels. As shown in Figure 3.7-18, the installed storage capacity for gas increases through the transition to around 60 TWh by 2050. Hydrogen storage is the major gas stored through the transition, with a major share for methane gas in 2050. CO₂ storage and CO₂ direct air capture, which are vital in the production of synthetic fuels, are installed from 2040 onwards. The installed

capacity for CO₂ storage and CO₂ direct air capture increases up to around 580 MtCO₂ by 2050, as shown in Figure 3.7-18. The major share of installed storage capacity is CO₂ direct air capture, which is on an annual basis as compared to CO₂ storage. Despite having a lower storage capacity, CO₂ storage has a substantial utilisation and correspondingly higher throughput.

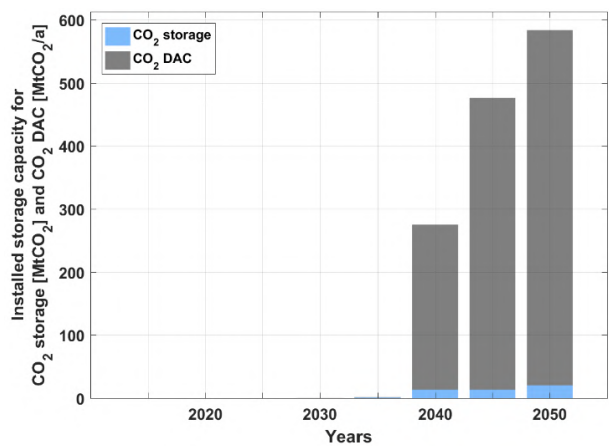
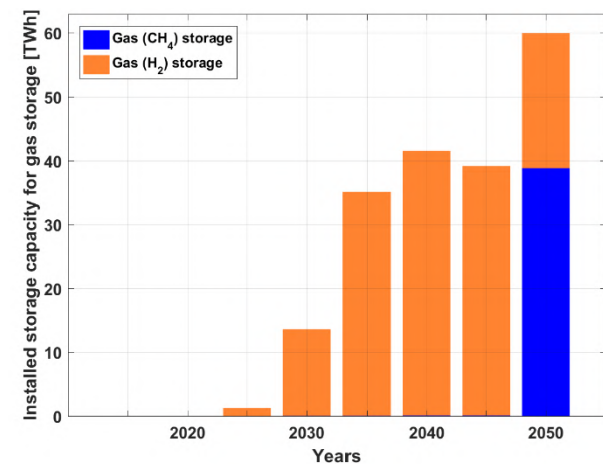

Figure 3.7-18: Northeast Asia – Transport sector installed capacity for gas (methane and hydrogen) storage (left) and CO₂ direct air capture and CO₂ storage (right) during the energy transition from 2015 to 2050.

Fuel costs are a deciding factor in the overall energy mix for the transport sector across Northeast Asia and their developing trends are highlighted in Figure 3.7-19. FT and SNG fuel costs decline through the transition up to 2050 and FT fuels are cost competitive with fossil liquid fuels including GHG emissions costs, at around 74 €/MWh in 2050. In addition, SNG is more cost effective than LNG in 2050. Electricity emerges as the most cost effective option with LCOE primary

around 13 €/MWh and along with complementary costs of storage and other system components, total LCOE is around 28 €/MWh in 2050. H₂ fuel costs decline to be more cost competitive than fossil fuels, in the range of 57 €/MWh in 2050, while liquid H₂ is in the range of 61 €/MWh. CO₂ from DAC is a critical component for synthetic fuels at around 31 €/MWh in 2050, using waste heat, as shown in Figure 3.7-19.

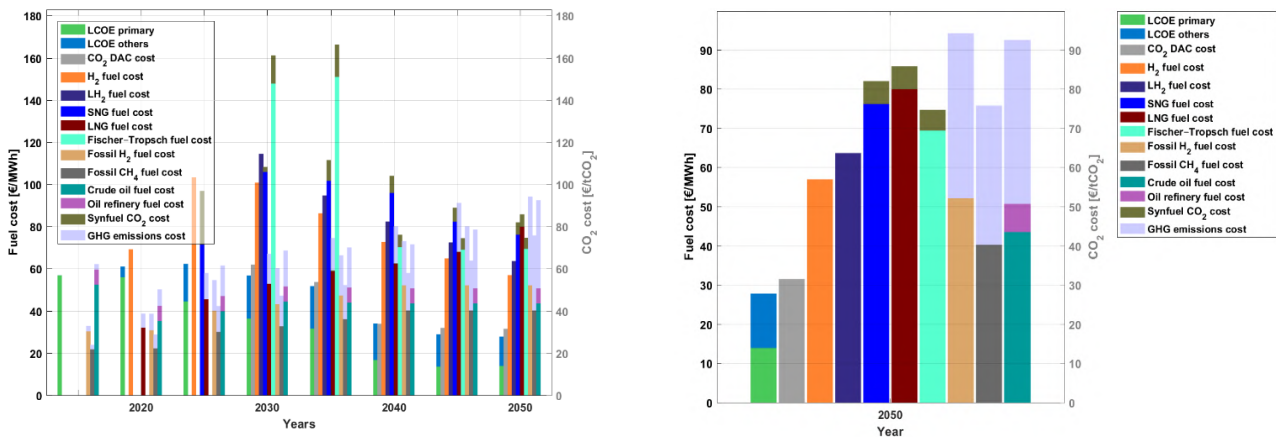

Figure 3.7-19: Northeast Asia – Fuel costs for the transport sector during the energy transition from 2015 to 2050 (left) and fuel costs in 2050 (right).

The total annual energy costs for transport are in the range of 410-530 b€ through the transition period with a decline from around 460 b€ in 2015 to about 410 b€ by 2050, as shown in Figure 3.7-20. Furthermore, annual system costs transition from being heavily dominated by fuel costs in 2015 to a very diverse share of costs across various technologies for electricity, synthetic fuels and sustainable biofuel production by 2050, as

highlighted in Figure 3.7-20. The difference in annual final transport energy and system costs is predominantly due to additional aspects of the system beyond 2040, as FT units produce naphtha as a by-product, that adds to the overall system costs. The cost for naphtha is allocated to the industry sector as input for the chemical industry, since it is a valuable feedstock.

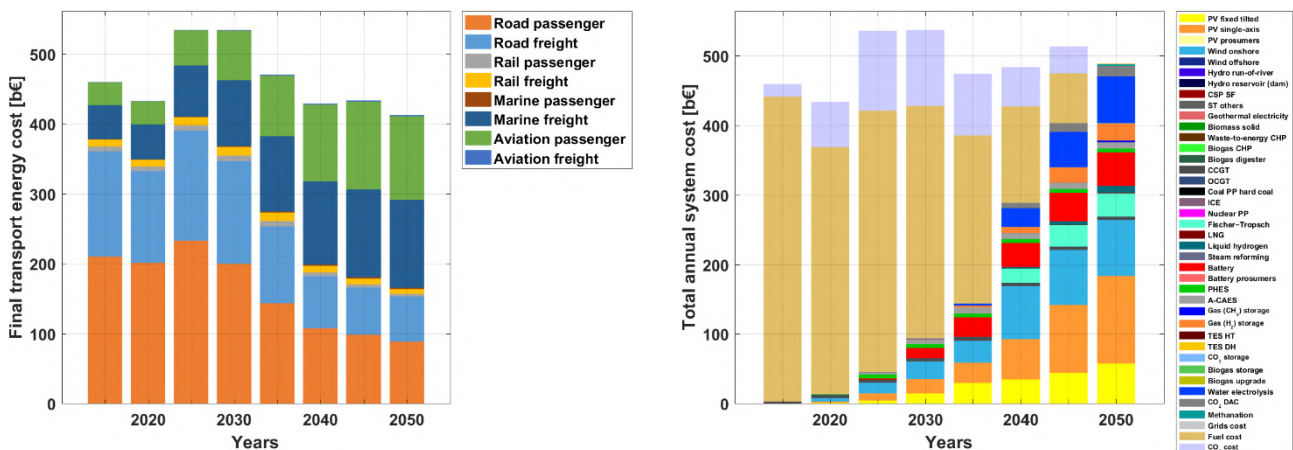

Figure 3.7-20: Northeast Asia – Final transport energy costs based on mode of transport (left) and source of energy (right) during the energy transition from 2015 to 2050.

The final transport passenger costs declines from around 0.098 €/p-km in 2015 to under 0.06 €/p-km by 2050, as shown in Figure 3.7-21. Final transport passenger costs decline for road transport through the transition, whereas for marine and aviation there is a marginal decrease. Similarly, final

transport freight costs decline from around 0.075 €/t-km in 2015 to 0.02 €/t-km by 2050, as shown in Figure 3.7-21. The final freight costs in the case of road declines through the transition, whereas it decreases slightly for rail and remains stable for aviation and marine.

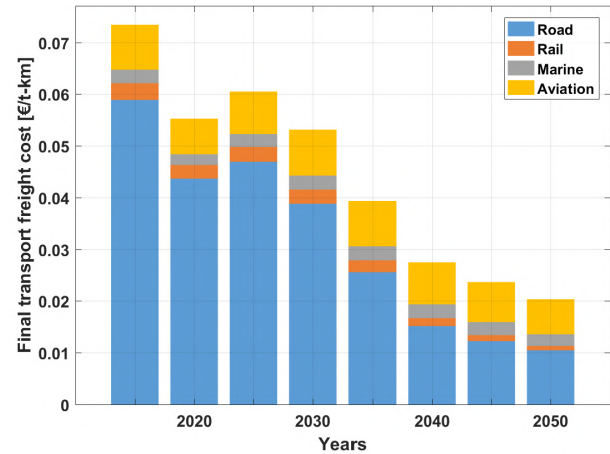
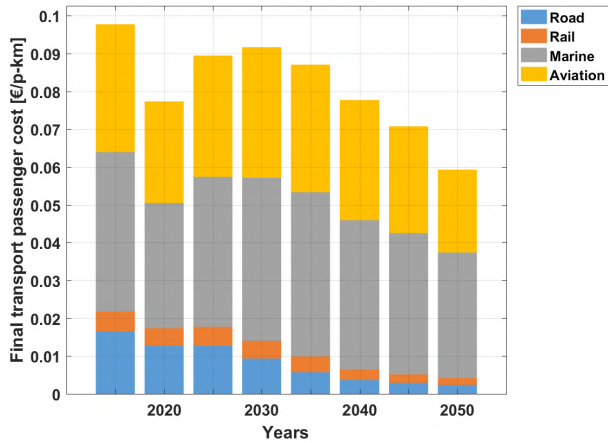

Figure 3.7-21: Northeast Asia – Final transport passenger cost (left) and final transport freight cost (right) during the energy transition from 2015 to 2050.

Desalination

The desalination demand in Northeast Asia arises 2030 onwards in a significant manner. Therefore, the installed capacities of power generation for the desalination sector increases from around 1 GW in 2015 to around 820 GW by 2050 as shown in

Figure 3.7-22. Solar PV and wind comprise the majority of installed capacities from 2030 until 2050. Primary electricity generation to meet the desalination demand in the initial period of the transition is from fossil gas up to 2030, beyond which PV and wind dominate as highlighted in Figure 3.7-22.

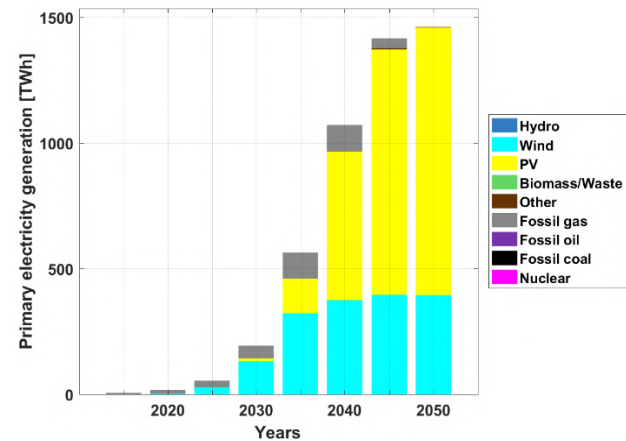
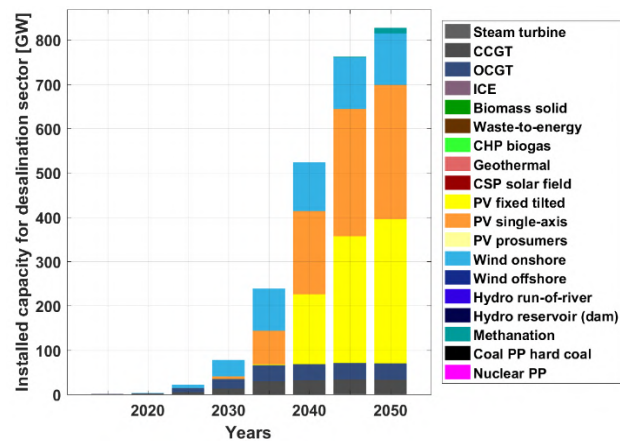

Figure 3.7-22: Northeast Asia – Technology-wise installed capacities for the desalination sector (left) and primary electricity generation for the desalination sector (right) during the energy transition from 2015 to 2050.

The installed storage capacity for desalination occurs mainly from 2035 onwards, with most of the capacity added in the final five-year period until 2050, as shown in Figure 3.7-23. Gas comprises more than 95% of the 38 TWh installed storage capacity in 2050, whereas batteries contribute the majority of the storage output, which reaches more than 550 TWh_{el} by 2050 as shown in Figure 3.7-23.

Investments in power generation for the desalination sector occur mainly during 2030 to 2050, as shown in Figure 3.7-24. A majority of the investment is in wind, PV, and batteries, which reaches a high of over 180 b€ in 2040. The levelised cost of water increases through the transition from around 1.05 €/m³ in 2015 to over 1.2 €/m³ by 2050, as shown in Figure 3.7-24.

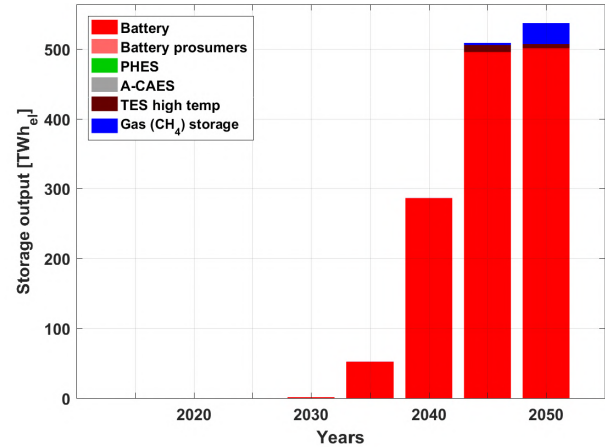
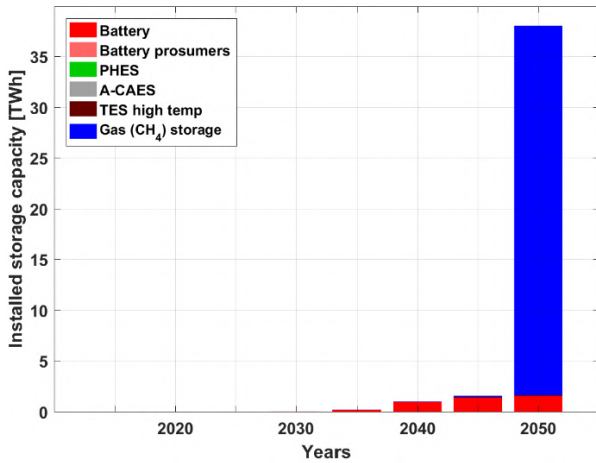

Figure 3.7-23: Northeast Asia – Installed storage capacity (left) and storage output (right) during the energy transition from 2015 to 2050.

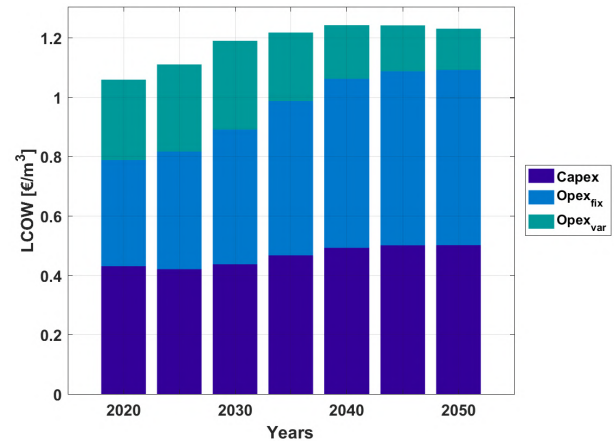
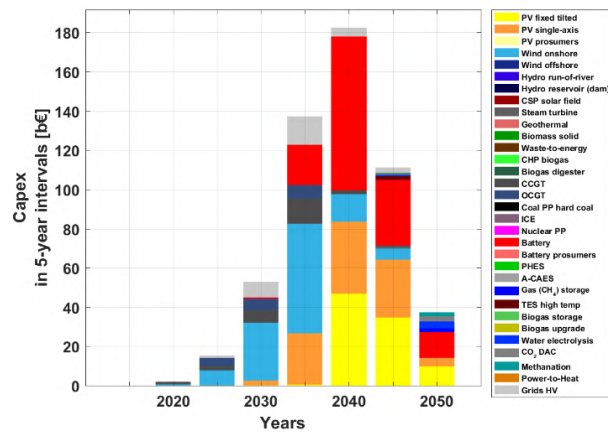

Figure 3.7-24: Northeast Asia – Capital costs for five-year intervals (left) and levelised cost of water (right) during the energy transition from 2015 to 2050.

Regional Outlook

Electricity generation capacities are installed across northeast Asia to satisfy the demand for power, heat, transport, and desalination up to 2050. Solar PV capacities are predominantly in the southern regions of northeast Asia that have better solar resources throughout the year, while wind energy capacities are mainly in the northern and western regions of Northeast Asia as in China Tibet and China North, as well as in China Northeast that have much better wind conditions, as shown in Figure 3.7-25. Additionally, a large share of wind energy capacities is installed in central parts of

China, which is northeast of Tibet and has almost 50% of electricity generation from wind. Overall, solar PV and wind capacities along with some hydropower capacities constitute the majority of installed capacities in 2050 across Northeast Asia. Similarly, higher shares of solar PV generation are in the southern regions and higher shares of wind energy are in the northern and western regions as highlighted in Figure 3.7-25. This could enhance the complementarity of solar PV and wind in an interconnected Northeast Asian energy system.

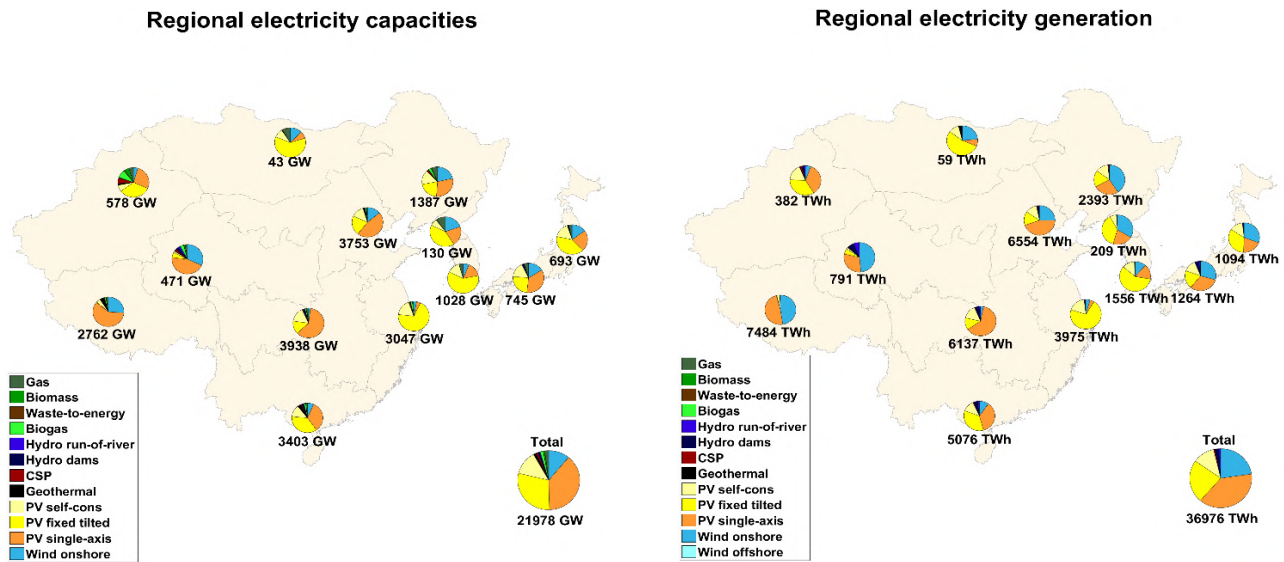

Figure 3.7-25: Northeast Asia – Regional electricity generation capacities (left) and electricity generation (right) in 2050.

Solar PV capacities are well distributed across the different regions of Northeast Asia and achieve a total installed capacity base of almost 17,770 GW in 2050. Moreover, there are capacities across the regions and countries with good solar conditions throughout the year, as shown in Figure 3.7-26.

Whereas, wind energy capacities achieve a total installed capacity base of around 2420 GW in 2050 and are distributed across Northeast Asia, which have some good wind potential. This can be observed in Figure 3.7-26.

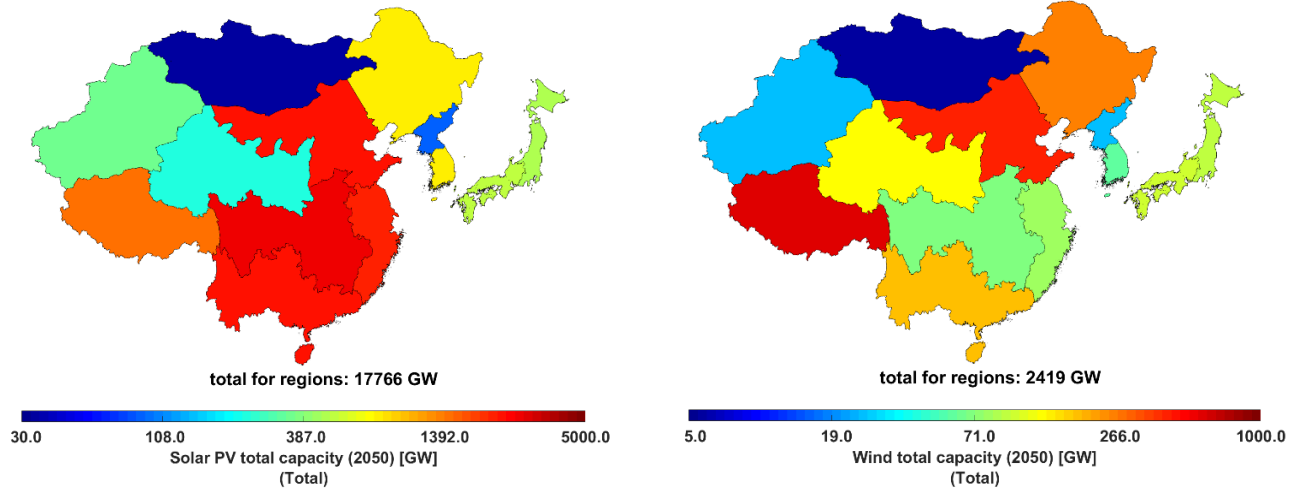

Figure 3.7-26: Northeast Asia – Regional variation of electricity generation capacities of solar PV (left) and wind energy (right) in 2050.

The electricity generation across the power, heat, transport, and desalination sectors of Northeast Asia are predominantly from PV and wind in 2050, which are well spread across the different regions as shown in Figure 3.7-27. Solar PV, which supplies an average of 73.3% of electricity generation across northeast Asia, is more common across all the regions of northeast Asia. While wind energy, which contributes an average of 22.8% of electricity

generation across northeast Asia, is mainly found in the northern and western regions of northeast Asia as in China (Tibet) and China (North), as well as in China Northeast and both regions of Japan. Overall, solar PV and wind generate most of the electricity needed across Northeast Asia by 2050, which is around 96.1% of total electricity generation.

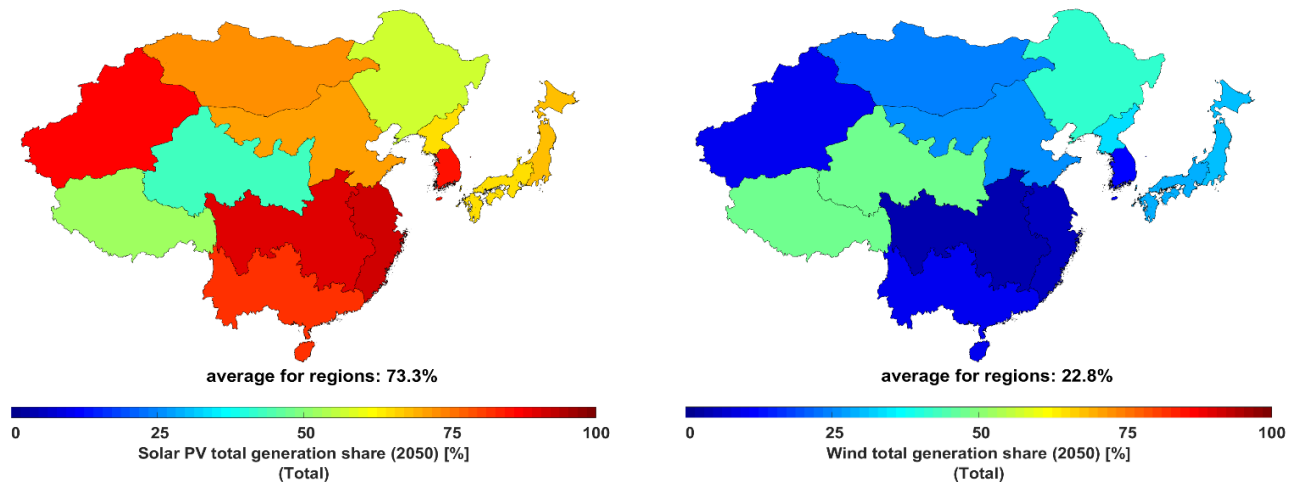

Figure 3.7-27: Northeast Asia – Regional variation of electricity generation shares of solar PV (left) and wind energy (right) in 2050.

Utility-scale and prosumer batteries contribute a major shares of electricity storage capacities, with some shares of PHEs and A-CAES by 2050, as shown in Figure 3.7-28. Storage capacities are much higher in the southern and eastern parts of Northeast Asia, to complement higher shares of installed solar PV capacities, compared to the

northern and western regions. Batteries, both prosumers and utility-scale, deliver the largest shares of output by 2050, as shown in Figure 3.7-28. PHEs and A-CAES contribute complementary shares of electricity storage output through the transition, mostly in the eastern regions of Northeast Asia.

Regional electricity storage capacities

Regional electricity storage annual generation

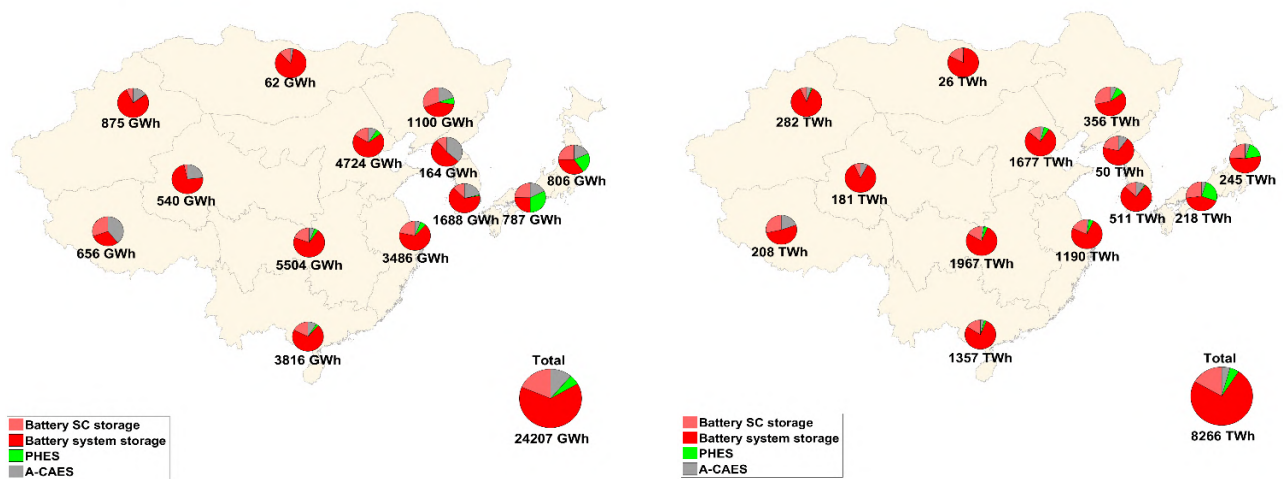

Figure 3.7-28: Northeast Asia – Regional electricity storage capacities (left) and electricity storage annual throughput (right) in 2050.

The storage output across the power, heat, transport, and desalination sectors of Northeast Asia is predominantly from batteries (both utility-scale and prosumers) and some synthetic natural gas supply in 2050, as shown in Figure 3.7-29. Batteries, which supply an average of 23.2% of the storage output across Northeast Asia, are present

across all the regions of Northeast Asia. Synthetic natural gas, which supplies an average of 0.2% of the total electricity demand across Northeast Asia, is predominant in the northern and western regions of Northeast Asia. This is complemented with a supply share of storage from biomethane of practically zero in 2050 across Northeast Asia.

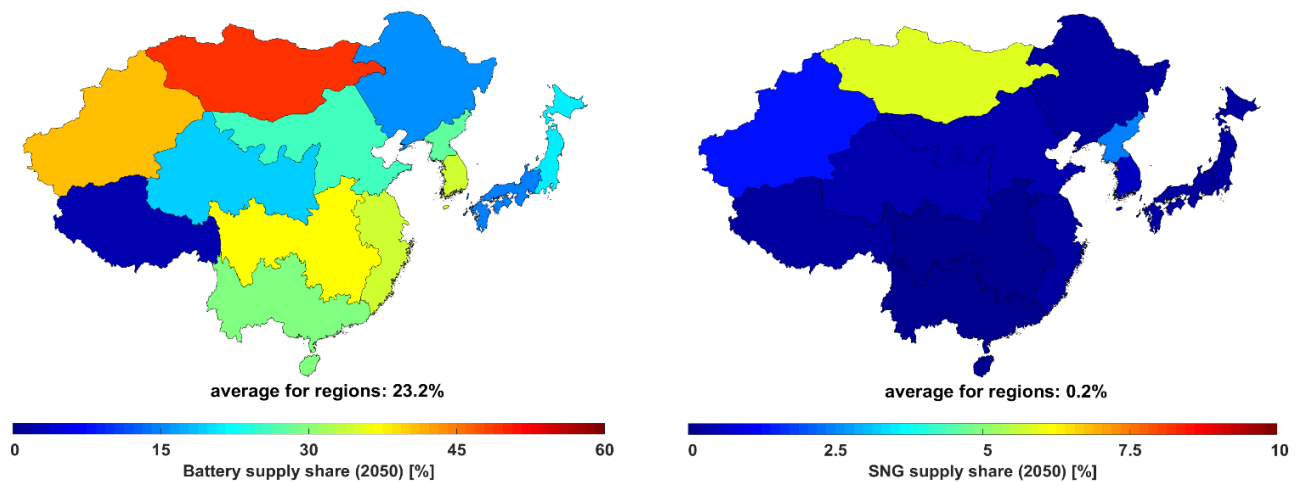

Figure 3.7-29: Northeast Asia – Regional variation of storage supply shares of batteries (left) and synthetic natural gas (right) in 2050.

Greenhouse Gas Emissions

The results of the energy transition towards a 100% renewable energy system indicate a sharp decline in GHG emissions until 2050, reaching zero GHG emissions by 2050 across the power, heat, transport, and desalination sectors in Northeast Asia as shown in Figure 3.7-30. The power sector undergoes a deep decarbonisation by 2030, whereas for the heat and transport sectors this occurs mostly between 2030 and 2050. Moreover,

the remaining cumulative GHG emissions comprise around 147 GtCO_{2eq} from 2018 to 2050. Therefore, the energy transition pathway for Northeast Asia is in adherence to the ambitious Paris Agreement target of 1.5°C. GHG emissions from the power sector decline through the transition from around 4,200 MtCO_{2 eq./a} in 2015 to zero by 2050 as shown in Figure 3.7-31. Similarly, GHG emissions from the heat sector decline through the transition from over 4,200 MtCO_{2 eq./a} in 2015 to zero by 2050 as shown in Figure 3.7-31.

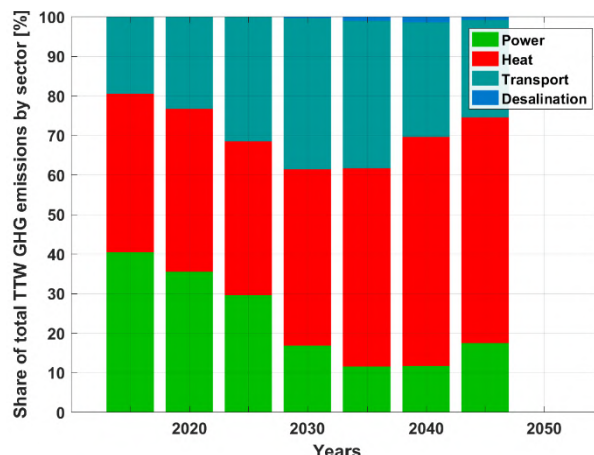
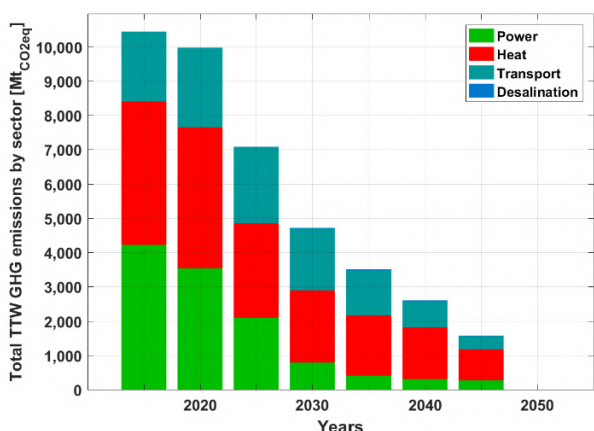

Figure 3.7-30: Northeast Asia – Sector-wise GHG emissions (left) and the share of GHG emissions of different sectors (right) during the energy transition from 2015 to 2050. Tank to Wheel (TTW) considers GHG emissions from readily available fuels and does not consider GHG emissions from the upstream production and delivery of fuels.

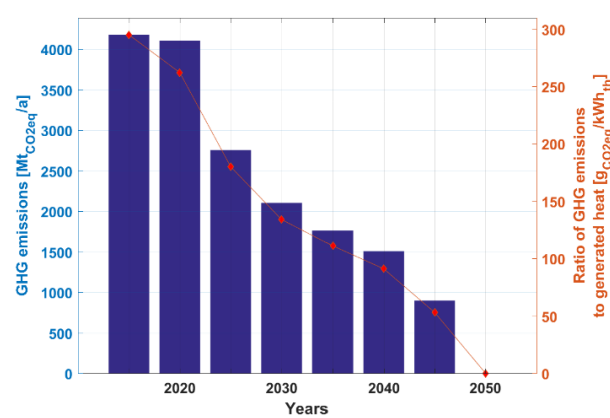
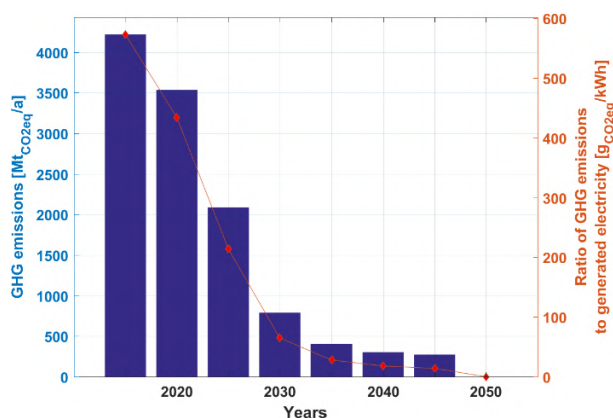

Figure 3.7-31: Northeast Asia – GHG emissions in the power sector (left) and GHG emissions in the heat sector (right) during the energy transition from 2015 to 2050.

GHG emissions from the transport sector decline through the transition from around 2,300 MtCO₂ eq./a in 2015 to zero by 2050, as shown in Figure 3.7-32. Whereas, GHG emissions from the desalination sector, which are much lower than

those of other sectors, increase through the transition from around 6 MtCO₂ eq./a in 2015 to around 38 MtCO₂ eq./a in 2040, thereafter dropping to zero by 2050, also visible in Figure 3.7-32.

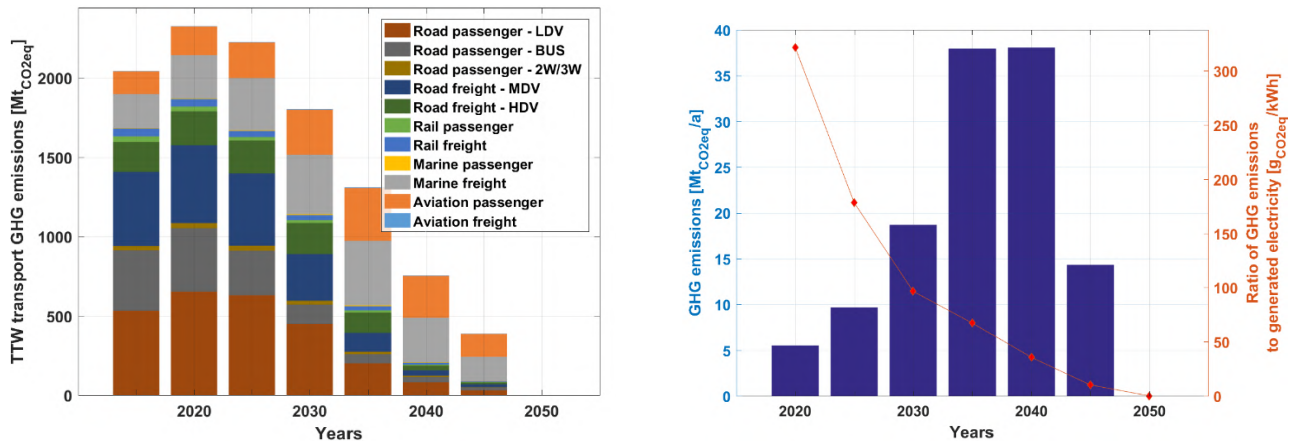

Figure 3.7-32: Northeast Asia – GHG emissions in the transport sector (left) and GHG emissions in the desalination sector (right) during the energy transition from 2015 to 2050. Tank to Wheel (TTW) considers GHG emissions from readily available fuels and does not consider GHG emissions from the upstream production and delivery of fuels.

Jobs in the Power Sector across Northeast Asia

From a renewables perspective, jobs are created from mainly wind (2 million jobs in 2025) and solar PV (3.5 million jobs in 2025) in the early stages of the transition. From 2030 onwards, solar PV is observed to be the main source of power generation and correspondingly creating the most number of jobs (6.7 million jobs by 2050) as indicated in Figure 3.7-33. Storage technologies led by batteries are observed to create a fair share

of jobs from 2030 onwards and continue unto 2050 with 1.3 million jobs in the battery sector. Whereas, jobs associated with the coal sector are seen to decrease rapidly. The total direct jobs are seen to increase from around 8 million in 2015 to 9.5 million by 2030 and after a decline, number of jobs rises back to around 10 million by 2050. Primarily with the replacements of power plants beginning to increase in the period from 2045 to 2050.

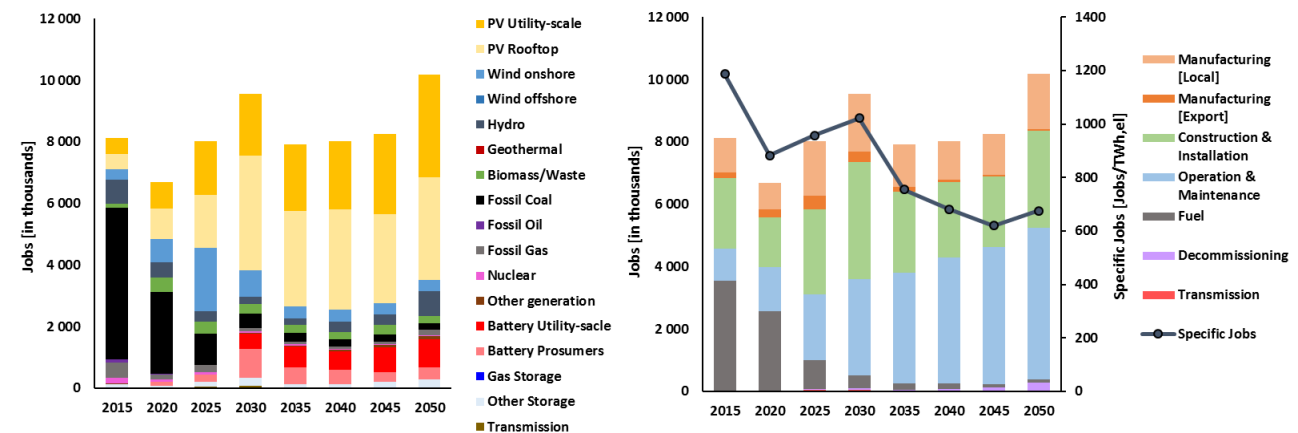

Figure 3.7-33: Northeast Asia – Jobs created by various power generation and storage technologies (left) and jobs created based on different categories with the development of electricity demand specific jobs (right) during the energy transition from 2015 to 2050.

With a ramp up of installations until 2030, the majority of jobs is created in the construction and installation of power generation technologies (39% of total jobs in 2030). Manufacturing jobs have a higher share in the initial periods up to 2030, beyond which the shares stabilise up to 2050. The Northeast Asian region contributes a major share of the global exports to all other regions. However, the share of jobs created by exports declines beyond 2030, as other regions are expected to increase their domestic production capabilities (exports creating just 36 thousand jobs by 2050). The share of fuel related jobs continue to diminish through the transition period from 43% of total jobs in 2015 to just 1% of total jobs by 2050, as

conventional power plants are replaced by renewable and storage technologies. By contrast, the share of operation and maintenance jobs grows through the transition period from 13% of total jobs in 2015 to 48% of total jobs in 2050. Additionally, decommissioning jobs that include replacement of end of life power plants begin to create some jobs by 2050 (293 thousand jobs). The electricity demand specific jobs is reduced from 1187 jobs/TWh_{el} in 2015 to 675 jobs/TWh_{el} by 2050, as shown in Figure 3.7-33. This is primarily due to the rising economic growth of the region forecasted for the future, resulting in much lower labour intensity by 2050.

3.8. Southeast Asia and the Pacific Rim

The Southeast Asian region including Australia, New Zealand and the Pacific Islands is comprised of rapidly growing economies, with around 7% share of global GDP⁶³. Population in Southeast Asia is 668 million in 2015 representing a share of 9% in world population, which is estimated to be also 9% in 2050. With fast-paced economic growth in most of these countries, the need for energy is ever increasing and some of the more developed countries have a high rate of consumption to sustain. The energy sector in Southeast Asia is vital to its overall development. Therefore, effective energy planning, optimal design, wise utilisation of all available renewable energy resources and

maximum synergy between various regions of the Southeast Asian countries will foster sustainable development in the region⁷³. The detailed results for the energy transition across Southeast Asia are available in a supplementary data file, the link for the file can be found in the Appendix.

Penetration of renewables is not just a matter of replacing hydrocarbons with zero-carbon sources of energy supply – it also represents a significant change in resource efficiency. This is illustrated by the overall electrification across the power, heat, transport, and desalination sectors as shown in Figure 3.8-1.

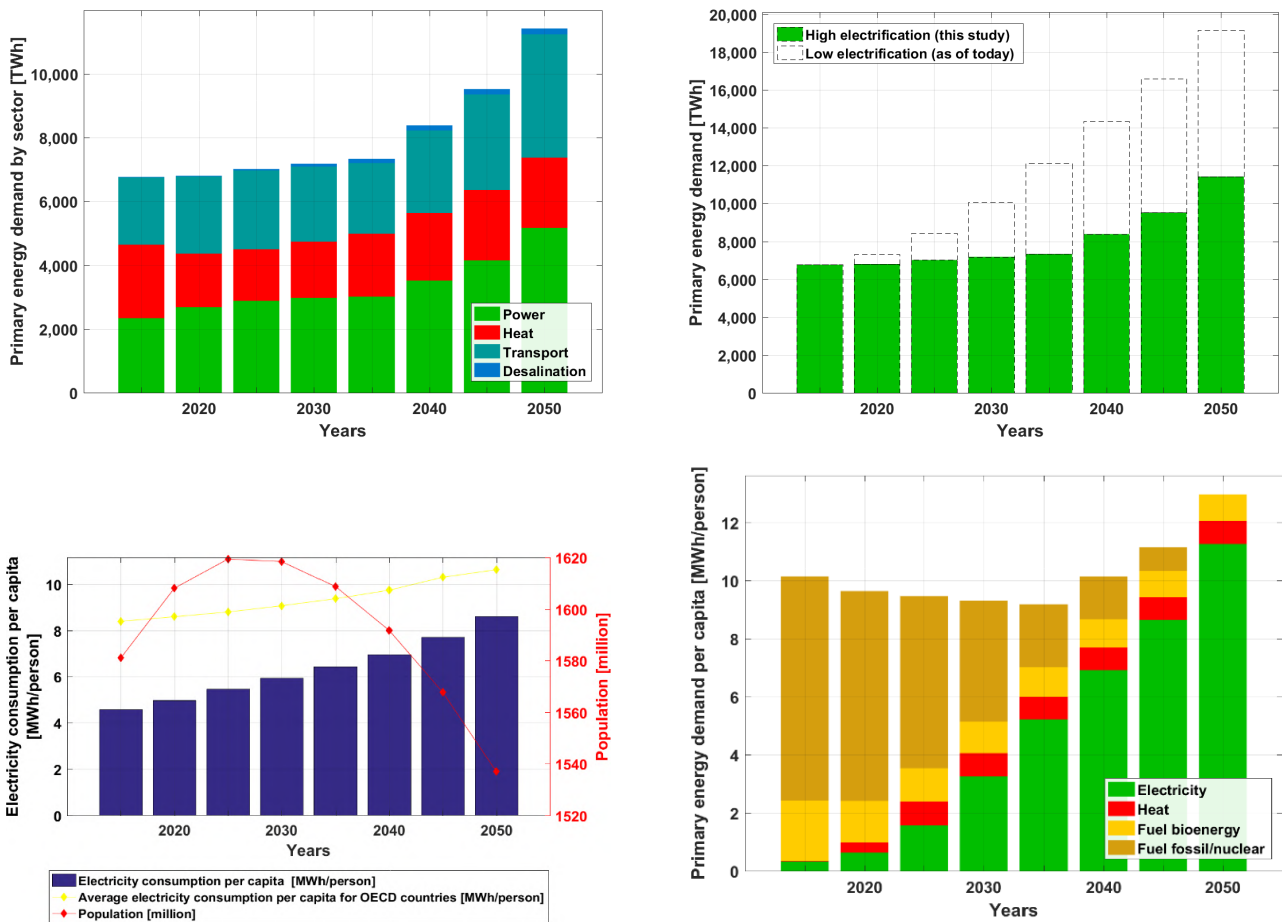

Figure 3.8-1: Southeast Asia – Primary energy demand sector-wise (top left), efficiency gain in primary energy demand (top right), electricity consumption per capita with population (bottom left) and primary energy demand per capita (bottom right) during the energy transition from 2015 to 2050.

The primary energy demand assuming high electrification, which is the basis for this study, increases marginally from 6,800 TWh in 2015 to around 7,200 TWh by 2035 and thereafter increases significantly up to 11,700 TWh by 2050 as shown in Figure 3.8-1. On the contrary, with low shares of electrification resulting from the adoption of current practices until 2050, the primary energy demand would reach nearly 19,000 TWh by 2050. The massive gain in energy efficiency is primarily due to a high level of electrification of more than 84% resulting in reduction of around 7,300 TWh by 2050, in comparison to the continuation of current practices with low shares of electrification. The population across Southeast Asia is expected to decline slightly from 1581 to 1537 million by 2050. Correspondingly, the average per capita energy demand decreases from around 10 MWh/person in 2015 to 9 MWh/person by 2035 and increases to over 12 MWh/person by 2050. However, a higher demand for industrial process heat reduces the overall gains and contributes to an increase in energy demand in the later years of the transition,

from 2035 to 2050. Additionally, a substantial demand from fuel conversion technologies arises beyond 2040, in producing renewable-based fuels for the transport sector across Southeast Asia.

Energy Supply

The electricity generation capacity across Southeast Asia satisfies demand from all energy sectors including power, heat, transport and desalination. The total installed capacity grows massively from around 300 GW in 2015 to around 5700 GW by 2050 as shown in Figure 3.8-2. In the initial period of the transition, some shares of wind capacities are installed up to 2030, but in the later part of the transition solar PV dominates the shares of installed capacities reaching almost 5340 GW by 2050. On the other hand, the shares of fossil fuels and nuclear decline through the transition to zero by 2050. Some shares of gas remain, but the fuel switches from fossil-based gas to synthetic natural gas produced with renewable electricity and biomethane.

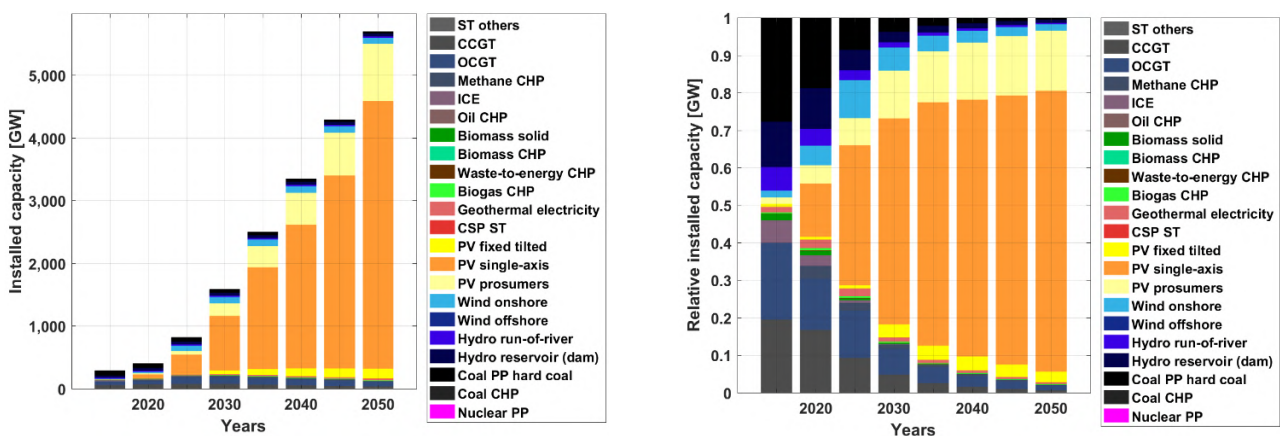

Figure 3.8-2: Southeast Asia – Technology-wise installed capacities (left) and technology-wise shares of installed capacities (right) during the energy transition from 2015 to 2050.

Electricity generation from the various technologies to cover the demand of power, heat, transport, and desalination sectors is shown in Figure 3.8-3. Solar PV supply increases through the transition from 58% in 2030 to about 90% by 2050, becoming the lowest cost energy source. Wind energy and hydropower contribute minor shares in the energy mix through the transition. In the heat sector, electric heating plays a significant role through the transition with a share of nearly 38% of heat

generation by 2050 on both the district and individual levels, as indicated in Figure 3.8-3. On the other hand, coal-based heating decreases through the transition from over 37% in 2015, to zero by 2050. Additionally, fossil fuel-based heating decreases through the transition period, as coal-based combined CHP and DH is replaced by electric heating, waste-to-energy CHP, biomass-based DH and IH along with some solar thermal heating.

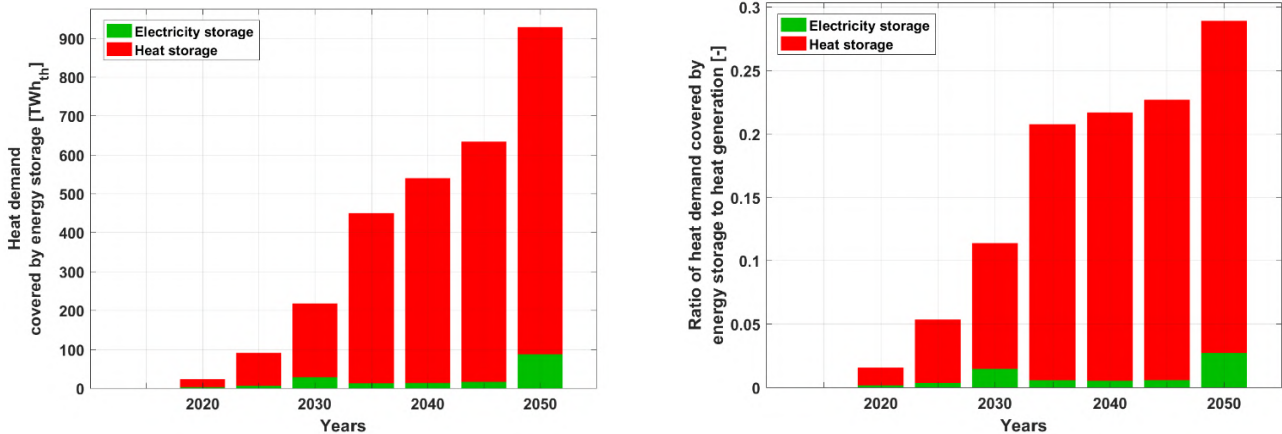

Figure 3.8-5: Southeast Asia – Heat demand covered by energy storage (left) and the ratio of heat demand covered by different forms of energy storage (right) during the energy transition from 2015 to 2050.

Costs and Investments

The total annual system costs are in the range of 240-450 b€ through the transition period and are well distributed across the major sectors of power, heat, and transport, as desalination demand in Southeast Asia is relatively smaller compared to other regions of the world as indicated by Figure 3.8-6. In addition, as shown in Figure 3.8-6, CAPEX

increases through the transition, while the share of fuel costs continue to decline. The steady increase in CAPEX-related energy system costs indicate that fossil fuels imports and the respective negative impacts on trade balances will fade out through the transition. In addition, lower fossil fuels import dependency will lead to higher levels of energy security across Southeast Asia.

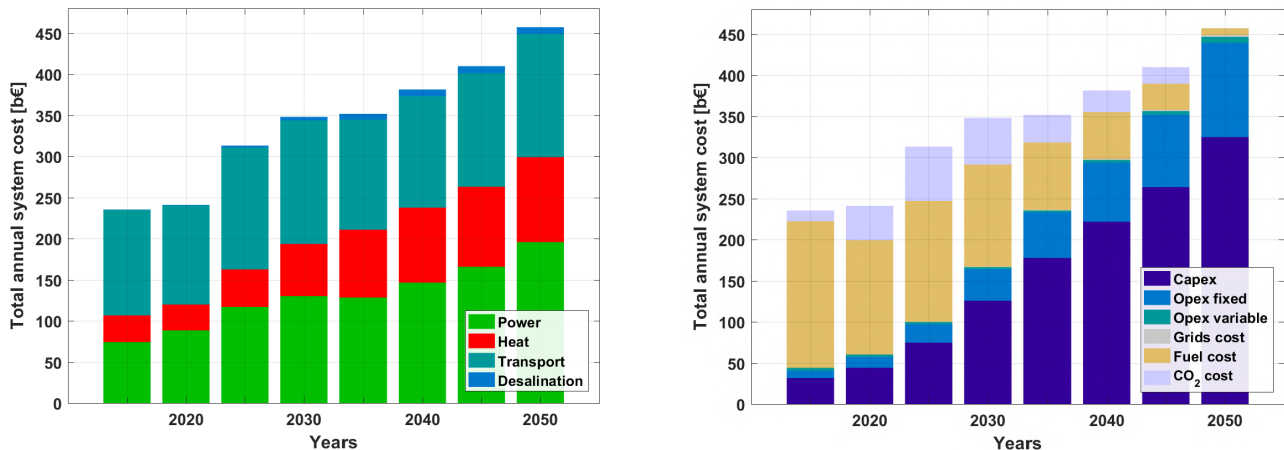

Figure 3.8-6: Southeast Asia – Annual system costs, sector-wise (left) and functionality-wise (right) during the energy transition from 2015 to 2050.

As increasing shares of power generation capacities are added across Southeast Asia, renewable energy sources become the least costing power generation sources⁶⁶. As indicated in Figure 3.8-7, levelised cost of energy remains around 42-53 €/MWh and is increasingly dominated by capital costs as fuel costs continue to decline through the transition period, which could mean increased self-

reliance in terms of energy for Southeast Asia by 2050 as mentioned earlier. Capital costs are well spread across a range of technologies with major investments for PV, wind energy, batteries, heat pumps, and synthetic fuel conversion up to 2050, as shown in Figure 3.8-7. The cumulative investments are about 4,100 b€ through the transition from 2016-2050.

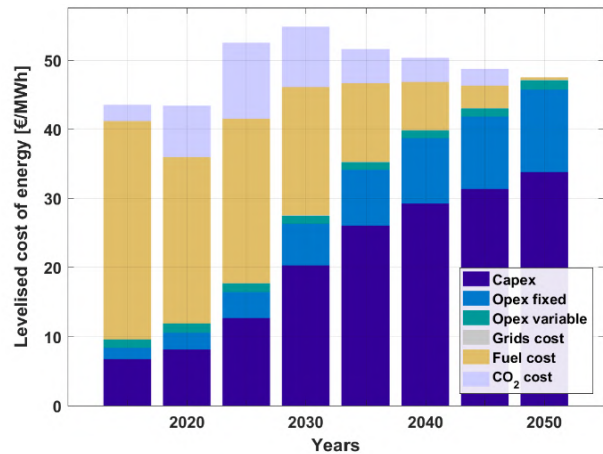
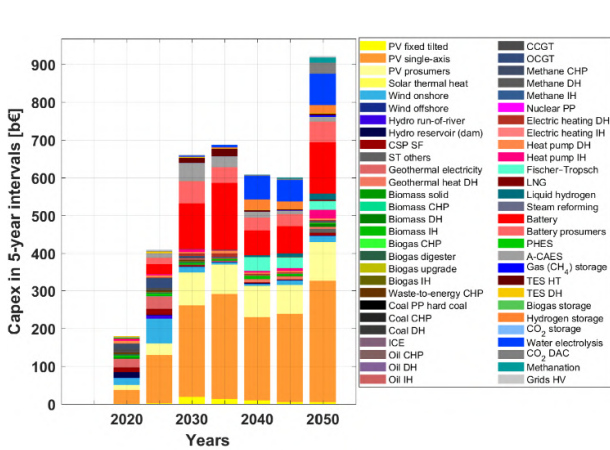

Figure 3.8-7: Southeast Asia – Capital costs for five-year intervals (left) and levelised cost of energy (right) during the energy transition from 2015 to 2050.

Outlook across Sectors

Different trends in the power, heat, transport, and desalination sectors across Southeast Asia emerge through the transition. As the sectors transition towards having higher shares of renewable energy, different technologies have vital roles in ensuring the stability of the energy system. A closer look at the individual sectors provides further insights into the energy transition across Southeast Asia towards 100% renewable energy.

Power and Heat

The total installed power generation capacity increases from nearly 250 GW in 2015 to around

3,500 GW by 2050, as shown in Figure 3.8-8. Across the power sector, solar PV with 3,200 GW and wind with 70 GW constitute the majority of installed capacities along with some share of hydropower by 2050. In the heat sector, heat pumps, electric heating, along with solar thermal and biomass-based heating constitute the majority of installed capacities by 2050, also shown in Figure 3.8-8. An increase in installed capacities of electric heating and biomass-based heating occurs in the final five-year period leading up to 2050, as fossil fuels are completely eliminated from the energy system.

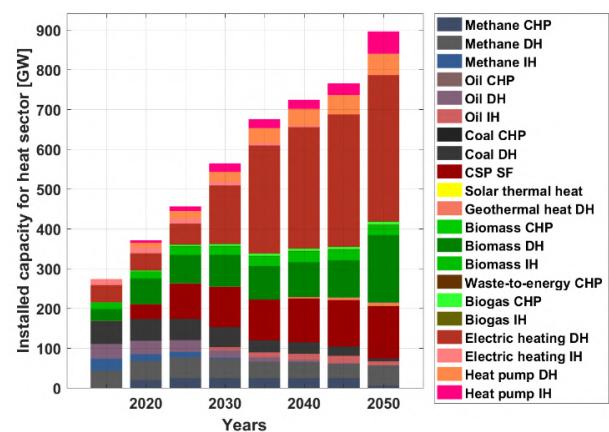
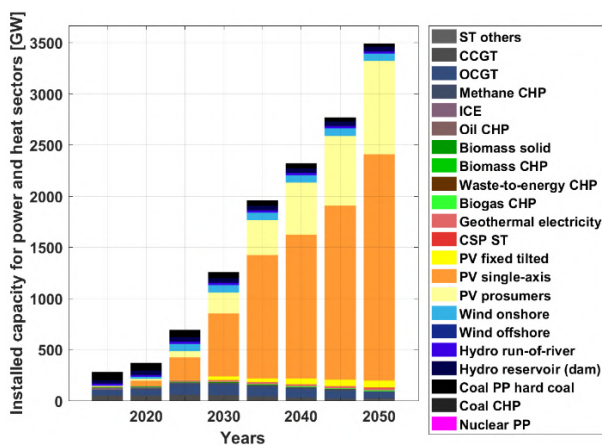

Figure 3.8-8: Southeast Asia – Technology-wise installed capacities for power (left) and heat (right) during the energy transition from 2015 to 2050.

The transition across Southeast Asia results in a power and heat sector dominated by fossil fuel and nuclear in 2015 moving towards a solar PV and wind energy dominated sector by 2050, with some hydropower, geothermal and bioenergy as shown in Figure 3.8-9. The primary electricity generation increases from around 1,250 TWh in 2015 to

around 6,100 TWh by 2050, which is primarily from PV and wind. Heat generation increases from around 1,200 TWh in 2015 to around 2,700 TWh by 2050, which is predominantly from electric heating and biomass-based heating, along with heat pumps and some solar thermal also shown in Figure 3.8-9.

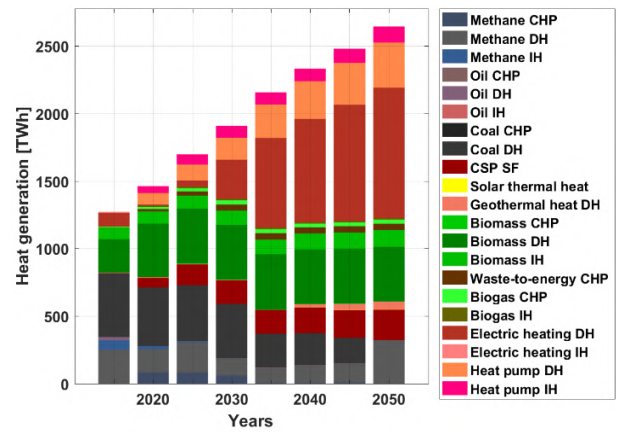
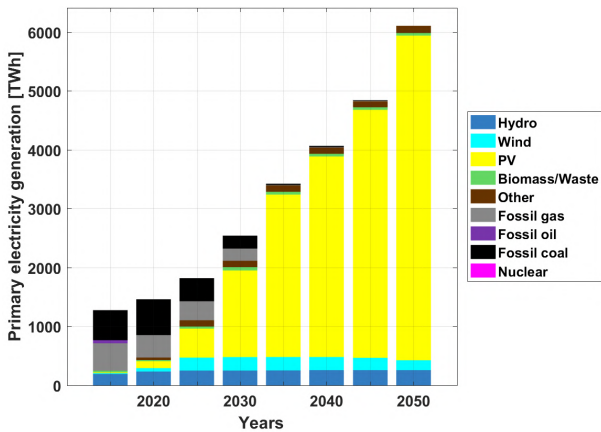

Figure 3.8-9: Southeast Asia – Primary electricity generation (left) and technology-wise heat generation (right) during the energy transition from 2015 to 2050.

The installed electricity storage capacities increase from just 0.1 TWh in 2015 to around 7 TWh by 2050, as shown in Figure 3.8-10. Utility-scale and prosumer batteries with some shares of A-CAES are installed through the transition. The installed capacities of A-CAES are also a consequence of the modelling approach, which prioritises full domestic energy supply for all Southeast Asian regions. The

installed heat storage increases gradually until 2045 to around 12 TWh, but in the final five-year period up to 2050, a massive capacity of gas storage of nearly 32 TWh is added, as shown in Figure 3.8-10. This substantial capacity addition is mainly to provide seasonal storage across Southeast Asia covering the heat demand in the absence of fossil fuels.

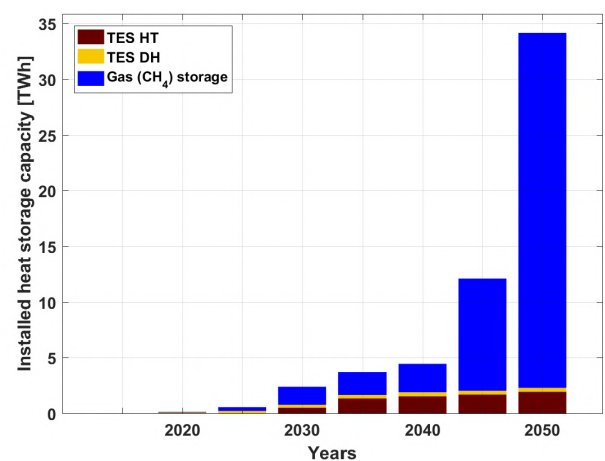
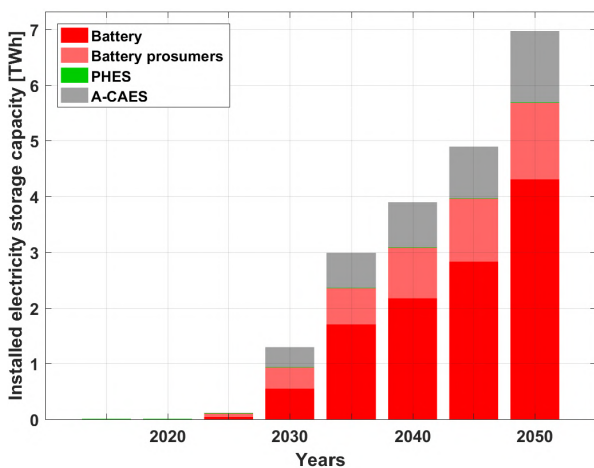

Figure 3.8-10: Southeast Asia – Installed electricity storage capacities (left) and heat storage capacities (right) during the energy transition from 2015 to 2050.

Utility-scale and prosumer batteries contribute a major share of electricity storage output with nearly 2,100 TWh_{el} by 2050, as highlighted by Figure 3.8-10. In addition, A-CAES contributes through the transition. TES emerges as the most relevant heat storage technology with around 67% of heat storage output by 2050, also seen in Figure 3.8-11.

Gas storage contributes around 33% of the heat storage output in 2050 covering predominantly seasonal demand, previously covered by fossil gas. LCOE of the power sector decreases substantially from around 63 €/MWh in 2015 to around 46

€/MWh by 2050, as shown in Figure 3.8-12. Moreover, LCOE is predominantly comprised of CAPEX as fuel costs decline through the transition. LCOH of the heat sector increases through the transition from around 16 €/MWh in 2015 to around 39 €/MWh by 2050, as shown in Figure 3.8-12. LCOH is predominantly comprised of CAPEX as fuel costs decline through the transition. Despite a substantial increase in heat demand across Southeast Asia, mainly driven by industrial process heat, the LCOH increase is relatively stable up to 2050.

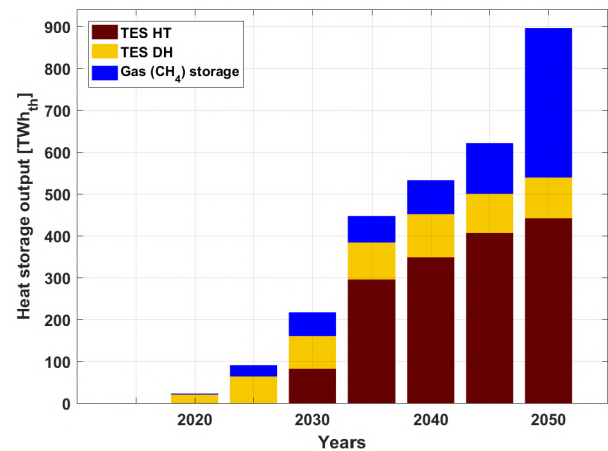
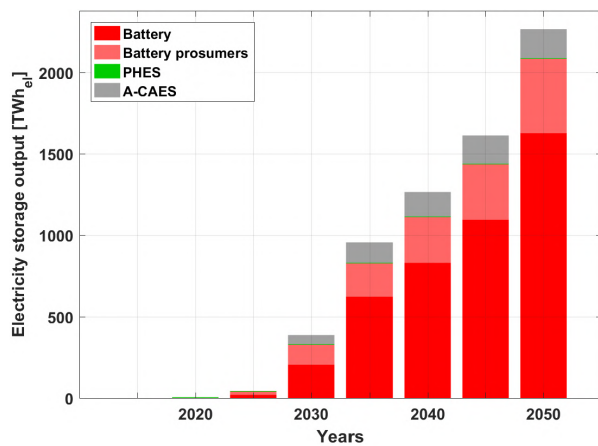

Figure 3.8-11: Southeast Asia – Electricity storage output (left) and heat storage output (right) during the energy transition from 2015 to 2050.

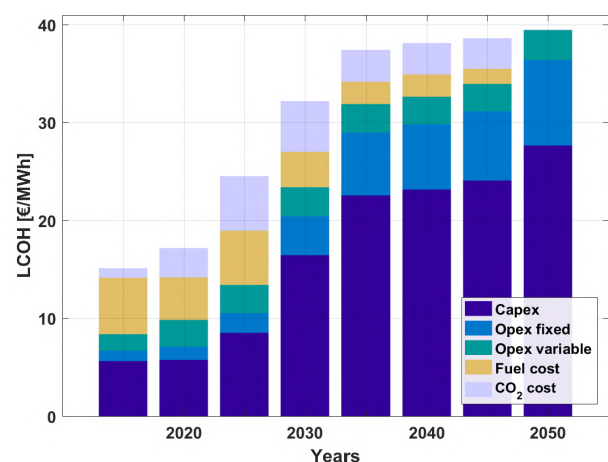
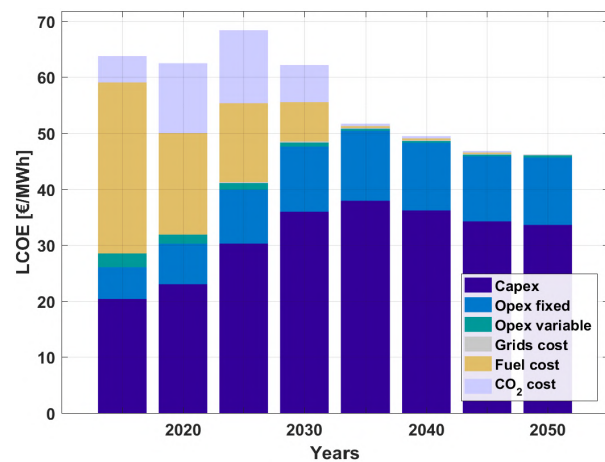

Figure 3.8-12: Southeast Asia – Levelised cost of electricity (left) and levelised cost of heat (right) during the energy transition from 2015 to 2050.

Investments are well spread across a range of power generation technologies with the majority share in solar PV through the transition up to 2050, as shown in Figure 3.8-13. Investments in the heat sector are mainly in electric heating and heat pumps with some shares in biomass heating up to

2050, also shown in Figure 3.8-13. The steep increase in heat pump investments in the final five-year period until 2050 is mainly to cover the heat demand in the absence of fossil fuels as well as the lower costs of heat pumps by 2050.

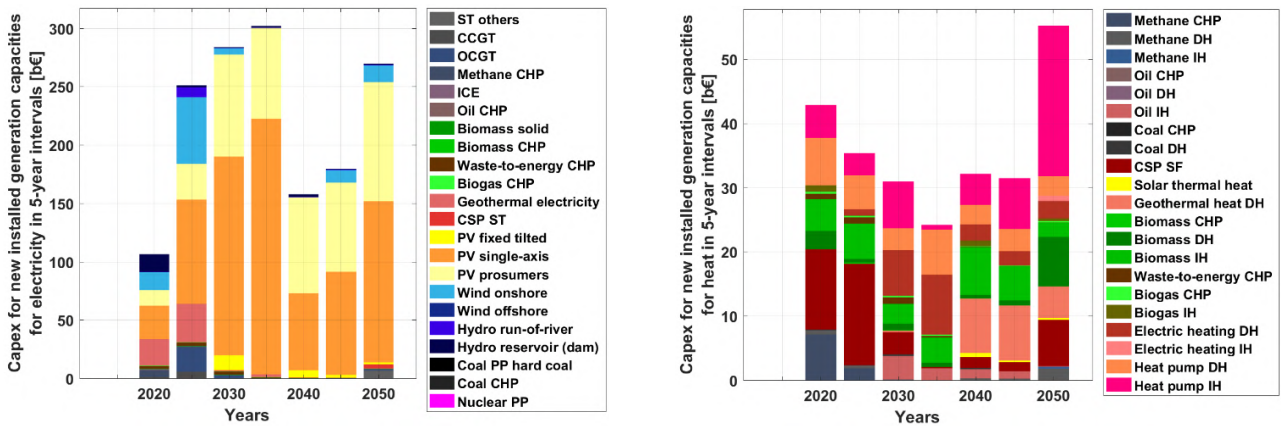

Figure 3.8-13: Southeast Asia – Capital costs of installed generation capacities in five-year intervals for electricity (left) and heat (right) during the energy transition from 2015 to 2050.

Transport

The primary energy demand of the transport sector across Southeast Asia is much more than the energy demand from the power sector at around 2,100 TWh in 2015. However, this demand increases marginally through the transition to around 2,500 TWh by 2050, mainly due to the efficiency gains brought about by electrification of the sector as shown in Figure 3.8-14. On the contrary, fossil fuels consumption in the transport sector across Southeast Asia is seen to decline through the transition from about 95% in 2015 to

zero by 2050. While, liquid fuels produced by renewable electricity contribute around 28% of final energy demand in 2050. In addition, hydrogen constitutes more than 24% of final energy demand in 2050. Sustainably produced biofuels contribute a minor share to enable a complete elimination of fossil fuel usage in the transport sector. Electrification of the transport sector creates an electricity demand of around 3,600 TWh_{el} by 2050. The massive demand for liquid fuels kicks in from 2040 onwards up until 2050, as indicated in Figure 3.8-14.

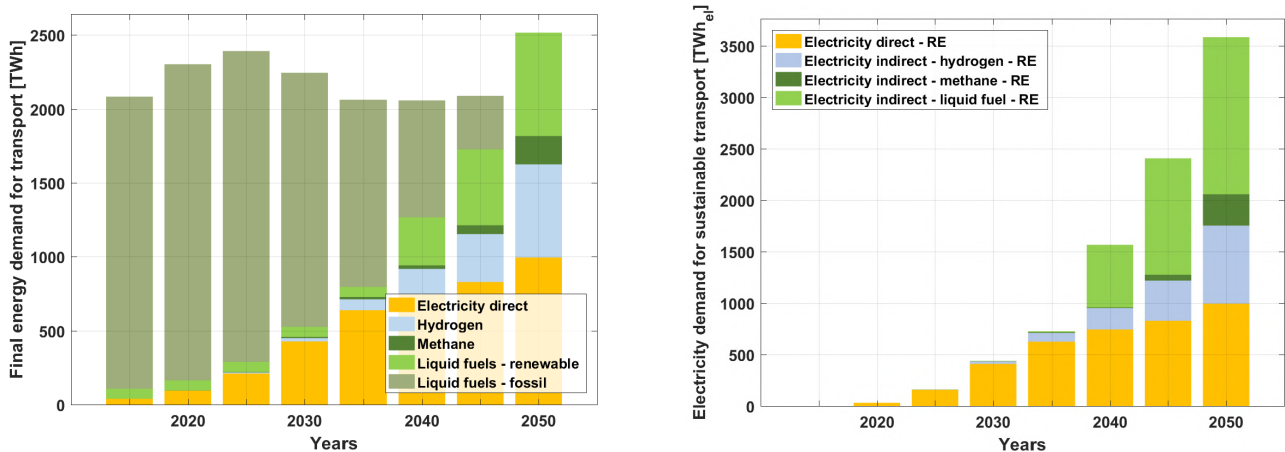

Figure 3.8-14: Southeast Asia – Final energy demand for transport (left) and electricity demand for sustainable transport (right) during the energy transition from 2015 to 2050.

Installed power generation capacities for the transport sector increases substantially through the transition to around 2,250 GW by 2050, as shown in Figure 3.8-15. Solar PV and wind form the majority shares of the power generation capacities for the transport sector, as they are the lowest cost energy sources by 2050. Similarly, electricity

generation increases substantially up to almost 3,800 TWh by 2050 also to be seen in Figure 3.8-15. Solar PV and minor shares of wind energy generate all the electricity required to meet the demand of the transport sector in 2050.

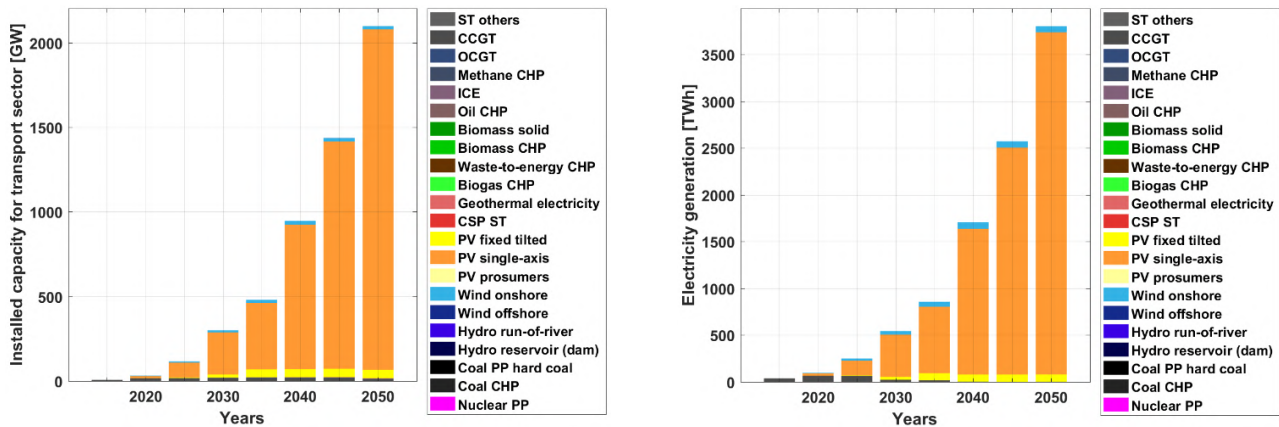

Figure 3.8-15: Southeast Asia – Transport sector installed power generation capacity (left) and electricity generation (right) during the energy transition from 2015 to 2050.

A critical aspect to complement the electrification of the transport sector is the installation of storage technologies. As seen in Figure 3.8-16, the installed capacities of electricity storage increase through the transition to around 1.6 TWh by 2050. The majority of installed capacities are utility-scale batteries and A-CAES. Similarly, electricity storage output increases through the transition to over 580 TWh_{el} by 2050 as shown in Figure 3.8-16. Utility-

scale batteries play a vital role as they contribute a major portion of the output through the transition, with over 500 TWh_{el} by 2050. The relatively low electricity storage of less than 15% of generated electricity for the transport sector is enabled by the flexible operation of batteries, water electrolyser units, and hydrogen buffer storage for synthetic fuel production.

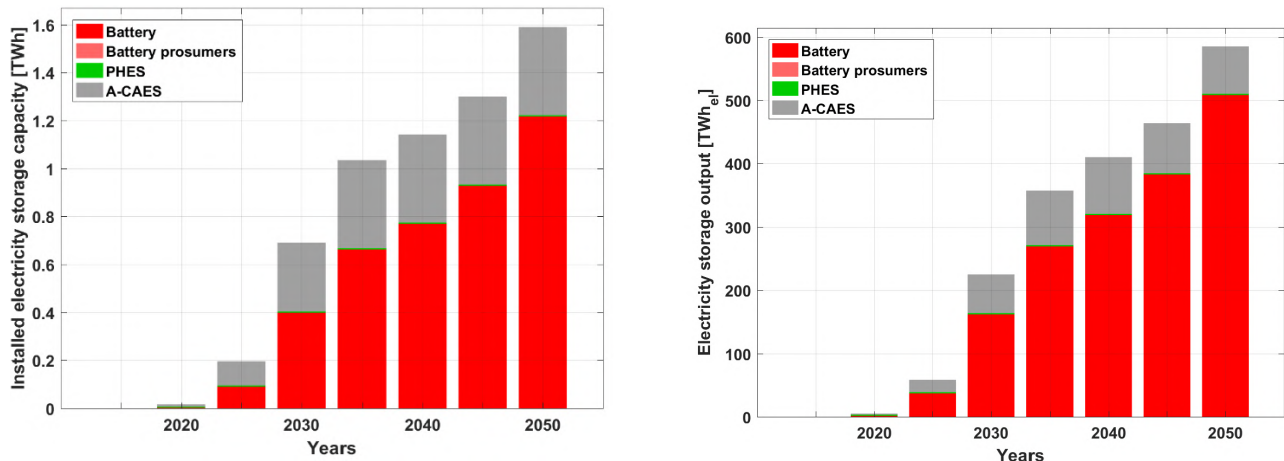

Figure 3.8-16: Southeast Asia – Transport sector installed electricity storage capacity (left) and electricity storage output (right) during the energy transition from 2015 to 2050.

An essential aspect in the transition of the transport sector towards higher electrification completely based on renewable energy is the production of synthetic fuels, hydrogen and sustainable biofuels. As indicated in Figure 3.8-17, the installed capacities of fuel conversion technologies increase substantially from 2040 onwards to over 1,100 GW by 2050. Water electrolysis forms the majority share

of fuel conversion capacities through the transition. Additionally, heat is needed during the production of synthetic fuels, mainly for energy-efficient CO₂ direct air capture, and this is enabled by managing process heat, which is otherwise not useable. Heat utilisation is in the range of 490 TWh_{th} by 2050, which is comprised of excess heat and recovered heat, as shown in Figure 3.8-17.

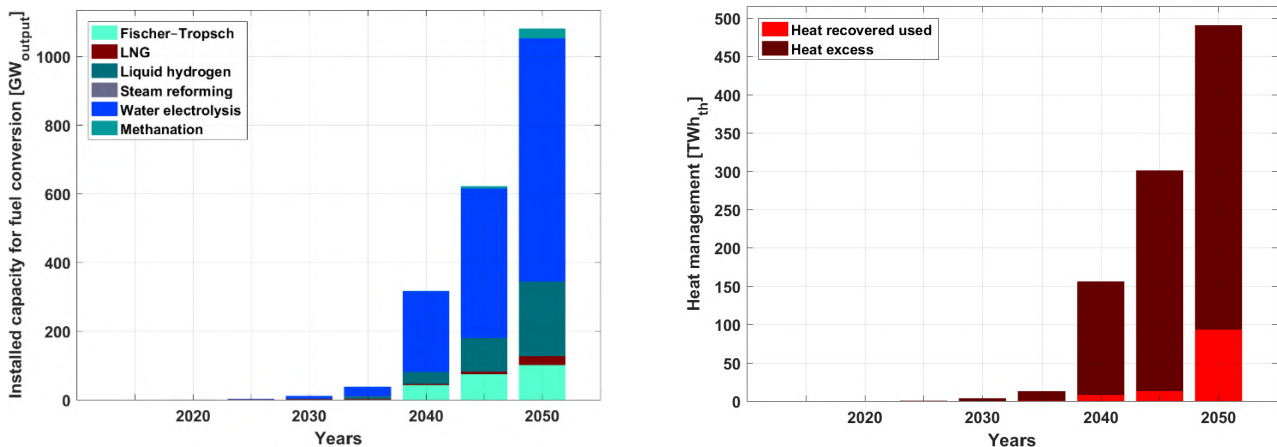

Figure 3.8-17: Southeast Asia – Transport sector installed capacity for fuel conversion (left) and heat management (right) during the energy transition from 2015 to 2050.

Similarly, gas storage is necessary in the production of synthetic fuels. As shown in Figure 3.8-18, the installed storage capacity for gas increases through the transition to around 4.5 TWh by 2050. Hydrogen storage is the major gas stored through the transition, with a minor share for methane gas in 2050. CO₂ storage and CO₂ direct air capture, which are vital in the production of synthetic fuels, are installed from 2040 onwards. The installed

capacity for CO₂ storage and CO₂ direct air capture increases up to around 87 MtCO₂ by 2050, as shown in Figure 3.8-18. The major share of installed storage capacity is CO₂ direct air capture, which is on an annual basis as compared to CO₂ storage. Despite having a lower storage capacity, CO₂ storage has a substantial utilisation and correspondingly higher throughput.

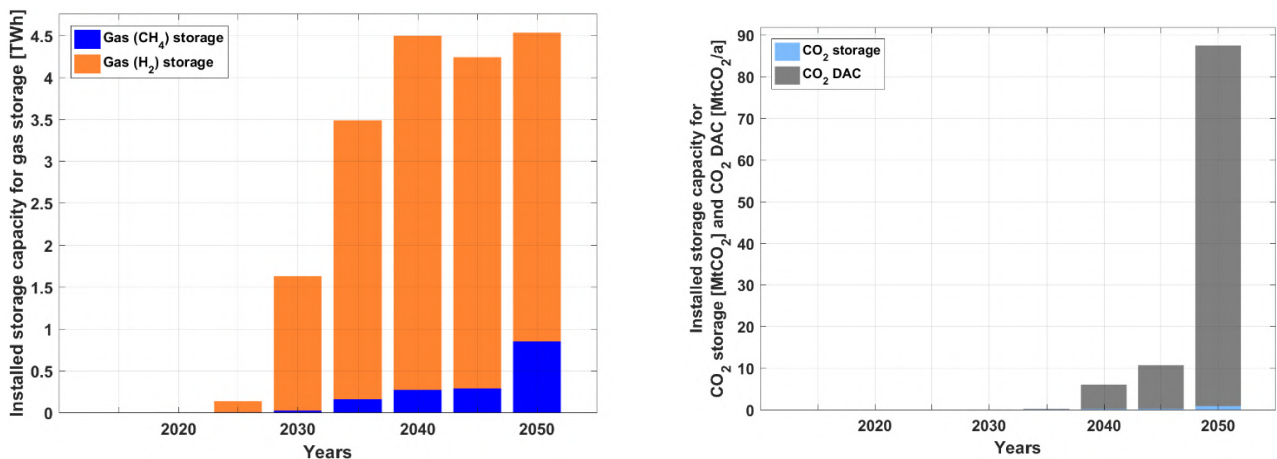

Figure 3.8-18: Southeast Asia – Transport sector installed capacity for gas (methane and hydrogen) storage (left) and CO₂ direct air capture and CO₂ storage (right) during the energy transition from 2015 to 2050.

Fuel costs are a deciding factor in the overall energy mix for the transport sector across Southeast Asia and their developing trends are highlighted in Figure 3.8-19. FT and SNG fuel costs decline through the transition up to 2050 and FT fuels are in the range of costs of fossil liquid fuels including GHG emissions costs, in the range of 88 €/MWh in 2050. In addition, SNG is more cost effective than LNG in 2050. Electricity emerges as the most cost effective option with LCOE primary

around 20 €/MWh and along with complementary costs of storage and other system components, total LCOE is around 27 €/MWh in 2050. H₂ fuel costs decline to be more cost competitive than fossil fuels, in the range of 49 €/MWh in 2050, while liquid H₂ is in the range of 57 €/MWh. CO₂ from DAC is a critical component for synthetic fuels at around 30 €/tCO_{2e,q} in 2050, using waste heat, as shown in Figure 3.8-19.

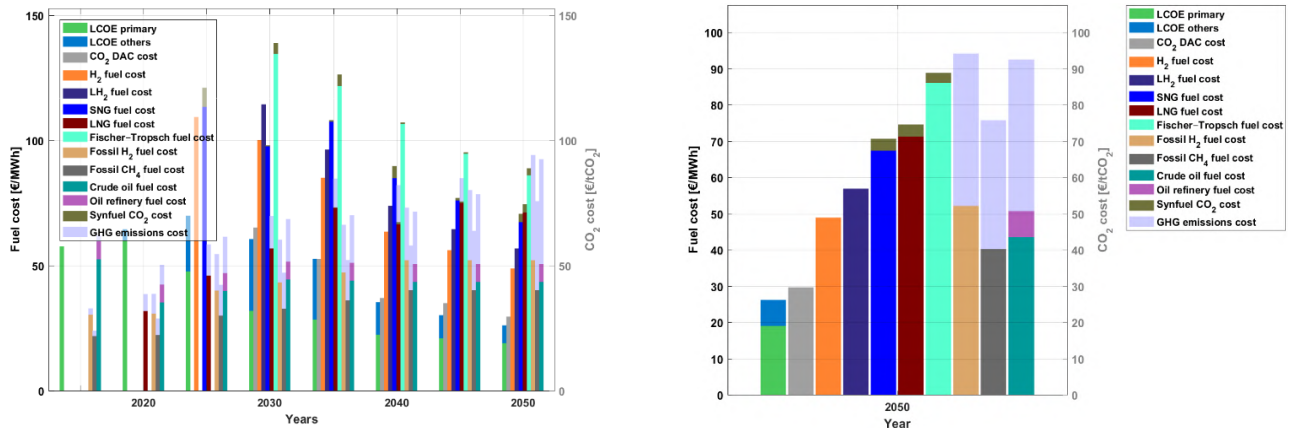

Figure 3.8-19: Southeast Asia – Fuel costs for the transport sector during the energy transition from 2015 to 2050 (left) and fuel costs in 2050 (right).

The final energy costs for transport are in the range of 120-150 b€ through the transition with a slight increase from around 125 b€ in 2015 to about 130 b€ by 2050, as shown in Figure 3.8-20. Furthermore, annual system costs transit from being heavily dominated by fuel costs in 2015 to a very diverse share of costs across various technologies for electricity, synthetic fuels and sustainable biofuel production by 2050, as

highlighted in Figure 3.8-20. The difference in annual final transport energy and system costs is predominantly due to additional aspects of the system beyond 2040, as FT units produce naphtha as a by-product, that adds to the overall system costs. The cost for naphtha is allocated to the industry sector as input for the chemical industry, since it is a valuable feedstock.

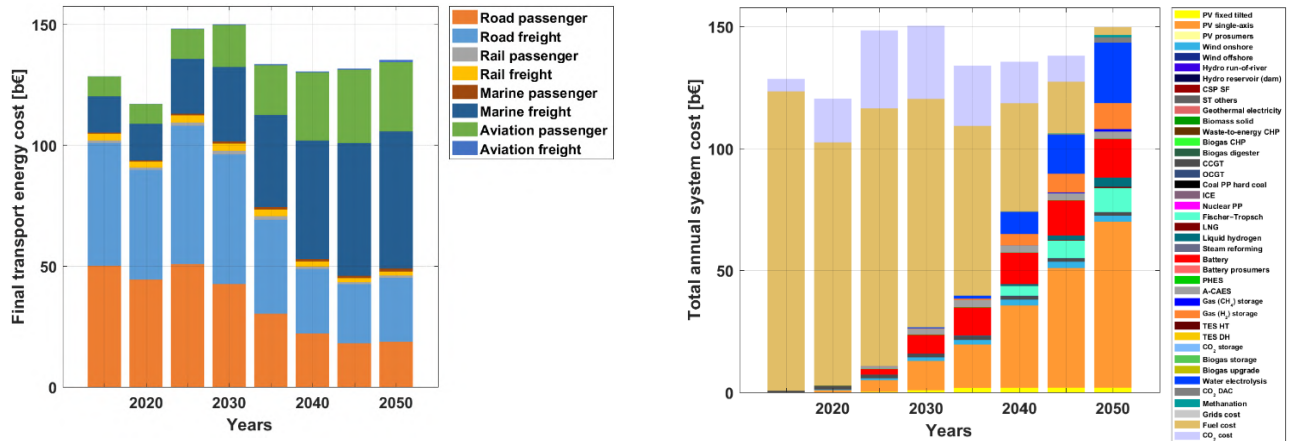

Figure 3.8-20: Southeast Asia – Final transport energy costs based on mode of transport (left) and source of energy (right) during the energy transition from 2015 to 2050.

The final transport passenger costs decline from around 0.095 €/p-km in 2015 to 0.06 €/p-km by 2050, as shown in Figure 3.8-21. Final transport passenger costs decline for road transport through the transition, whereas for marine and aviation there is a marginal decrease. Similarly, final

transport freight costs decline from around 0.105 €/t-km in 2015 to 0.029 €/t-km by 2050, as shown in Figure 3.8-21. The final freight costs in the case of road declines through the transition, whereas it remains stable for rail, aviation and marine.

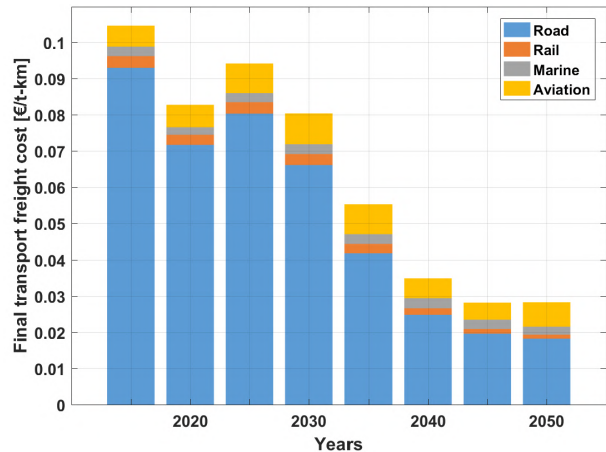
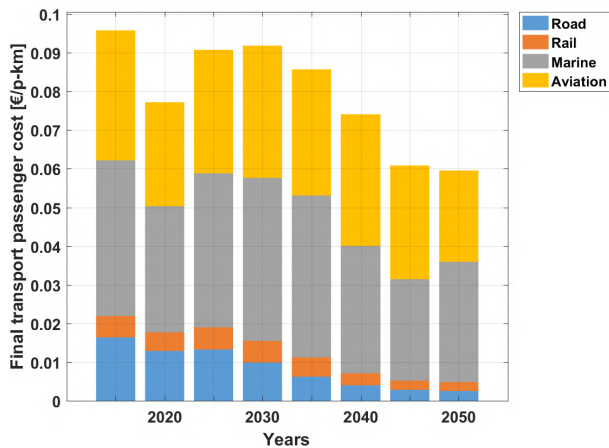

Figure 3.8-21: Southeast Asia – Final transport passenger cost (left) and final transport freight cost (right) during the energy transition from 2015 to 2050.

Desalination

The desalination demand in Southeast Asia is relatively small compared to other regions of the world. Therefore, the installed capacity of power generation for the desalination sector increases from around 1 GW in 2015 to over 110 GW by 2050 as shown in Figure 3.8-22. Solar PV and wind

comprise the majority of installed capacities from 2030 until 2050. Primary electricity generation to meet the desalination demand in the initial period of the transition is from fossil gas up to 2030, beyond which PV and wind dominate as highlighted in Figure 3.8-22.

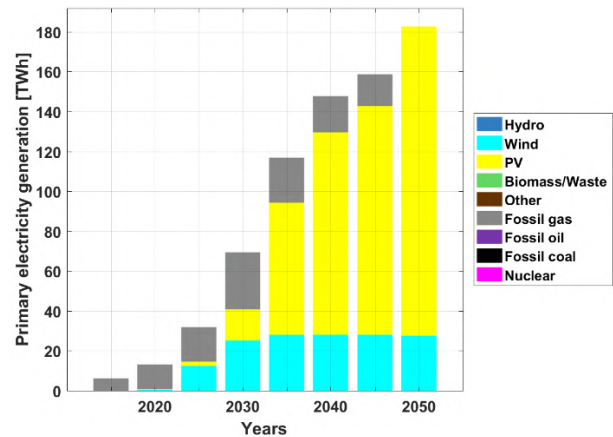
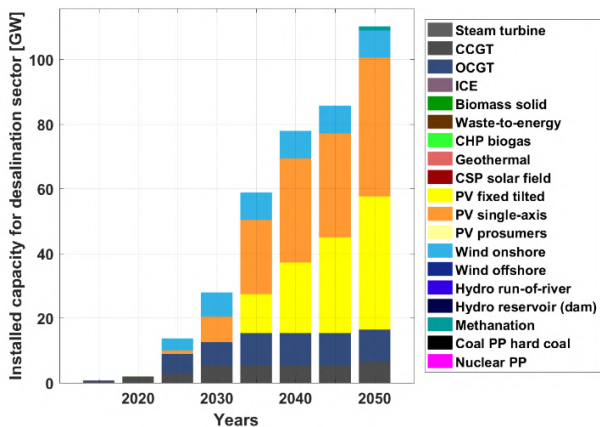

Figure 3.8-22: Southeast Asia – Technology-wise installed capacities for the desalination sector (left) and primary electricity generation for the desalination sector (right) during the energy transition from 2015 to 2050.

The installed storage capacity for desalination occurs mainly from 2035 onwards, with most of the capacity added in the final five-year period until 2050 as shown in Figure 3.8-23. Gas comprises more than 95% of the 7.9 TWh installed storage capacity in 2050, whereas batteries contribute the majority of the storage output, which reaches more than 75 TWh_{el} by 2050 as shown in Figure 3.8-23.

Investments in power generation for the desalination sector occur mainly during 2025 onwards, as shown in Figure 3.8-24. A majority of the investments are in wind, PV, and batteries, which reach a high of around 24 b€ in 2035. The levelised cost of water declines through the transition from around 0.85 €/m³ in 2015 to around 0.58 €/m³ by 2050, as shown in Figure 3.8-24.

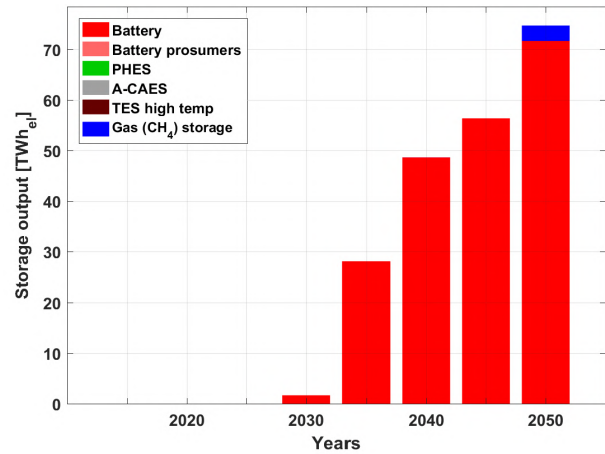
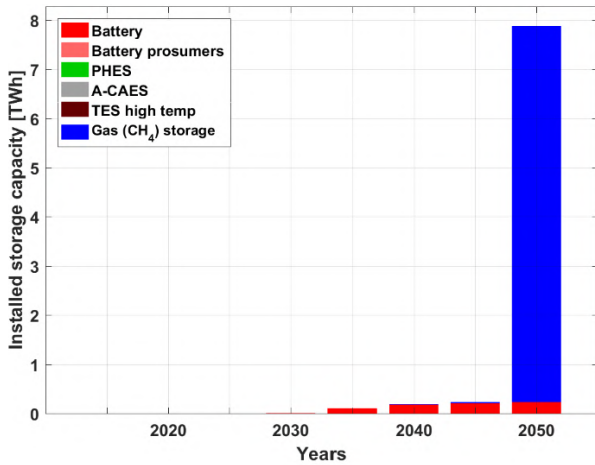

Figure 3.8-23: Southeast Asia – Installed storage capacity (left) and storage output (right) during the energy transition from 2015 to 2050.

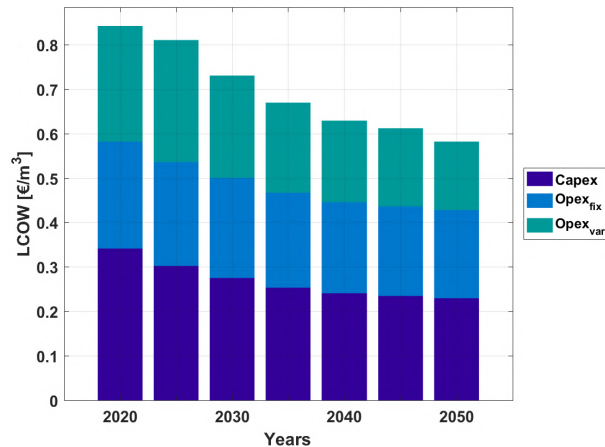
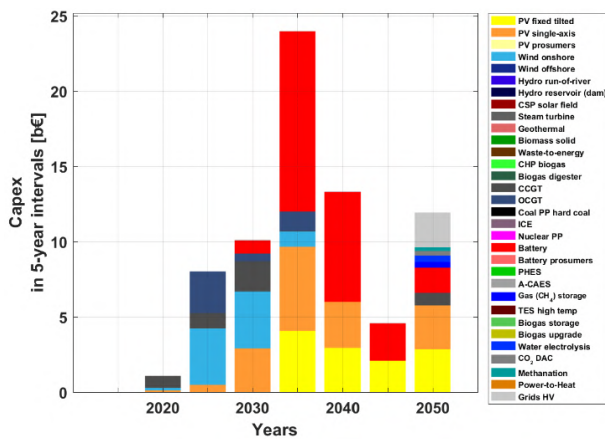

Figure 3.8-24: Southeast Asia – Capital costs for five-year intervals (left) and levelised cost of water (right) during the energy transition from 2015 to 2050.

Regional Outlook

Electricity generation capacities are installed across Southeast Asia to satisfy the demand for power, heat, transport, and desalination up to 2050. Solar PV capacities are predominant across all the regions of Southeast Asia that have better solar resources throughout the year, while wind energy capacities are scattered around the region with some significant shares in Western Australia and New Zealand that have much better wind conditions, as shown in Figure 3.8-25. Overall, solar

PV and wind capacities along with some hydropower capacities constitute the majority of installed capacity in 2050 across Southeast Asia. Similarly, higher shares of solar PV generation are all across Southeast Asia and higher shares of wind energy are in Australia and New Zealand as highlighted in Figure 3.8-25. This could enhance the complementarity of solar PV and wind in an interconnected across all the regions of Southeast Asian energy system.

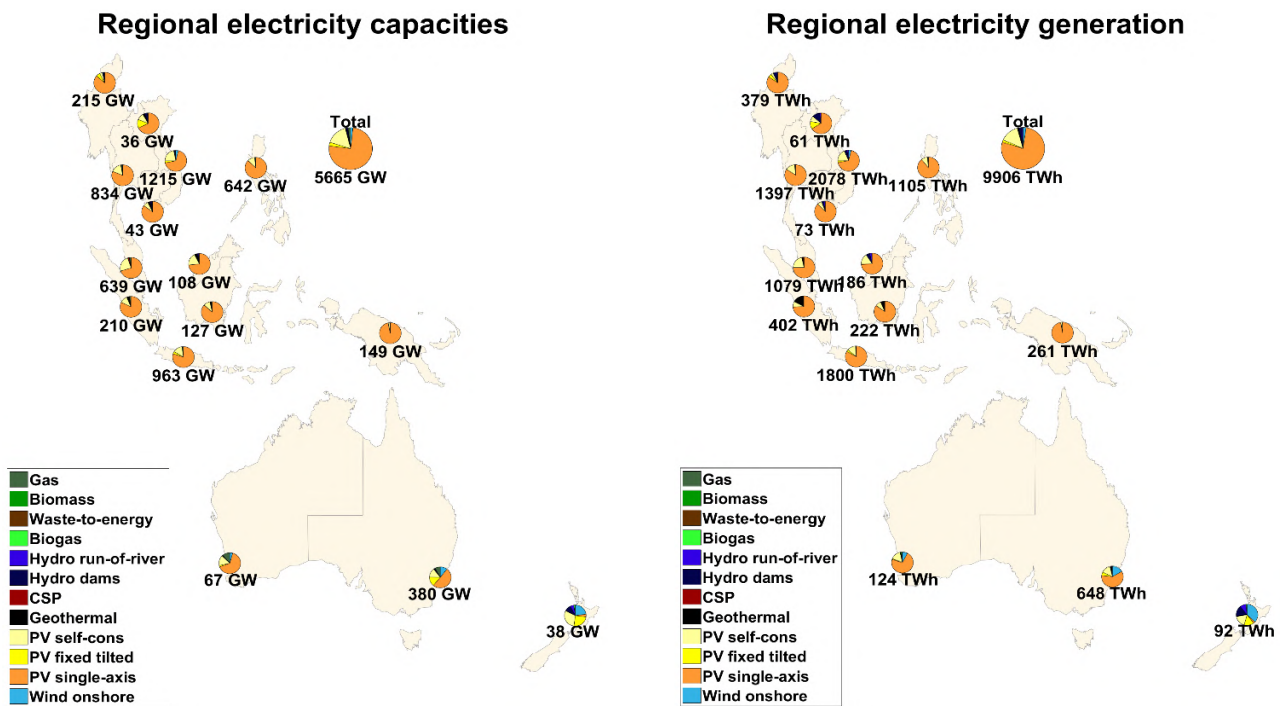

Figure 3.8-25: Southeast Asia – Regional electricity generation capacities (left) and electricity generation (right) in 2050.

Solar PV capacities are well distributed across the different regions of Southeast Asia and achieve a total installed capacity base of almost 5340 GW in 2050. Moreover, there are capacities across the regions and countries with good solar conditions throughout the year, as shown in Figure 3.8-26.

Whereas, wind energy capacities achieve a total installed capacity base of nearly 100 GW in 2050 and are predominantly in Eastern Australia and New Zealand, which have some wind potential. This can be observed in Figure 3.8-26.

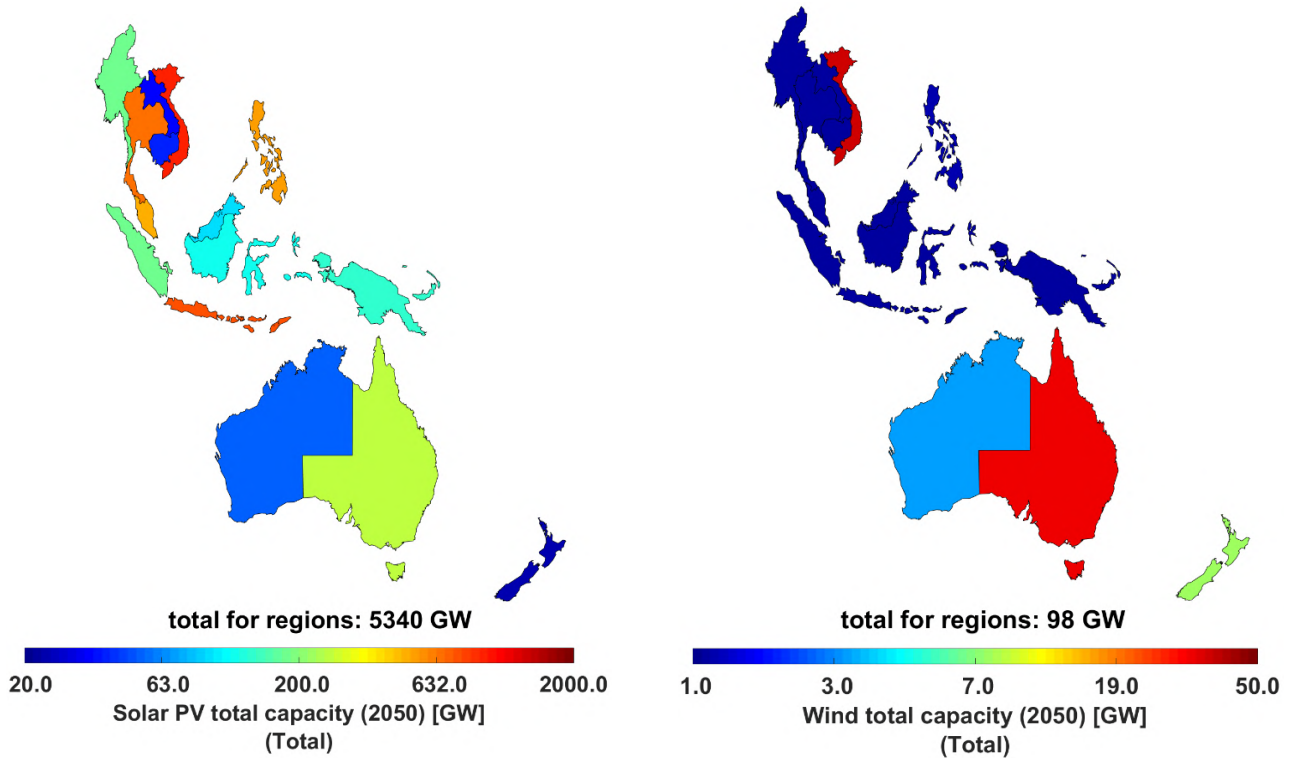

Figure 3.8-26: Southeast Asia – Regional variation of electricity generation capacities of solar PV (left) and wind energy (right) in 2050.

The electricity generation across the power, heat, transport, and desalination sectors of across Southeast Asia are predominantly from PV and wind in 2050, which is spread across the region as shown in Figure 3.8-27. Solar PV, which supplies an average of 93.2% of electricity generation across Southeast Asia, is more common. While wind

energy, which contributes an average of 2.6% of electricity generation across Southeast Asia, is mainly found in Australia and New Zealand. Overall, solar PV and wind generate most of the electricity needed across Southeast Asia by 2050, which is around 95.8% of total electricity generation.

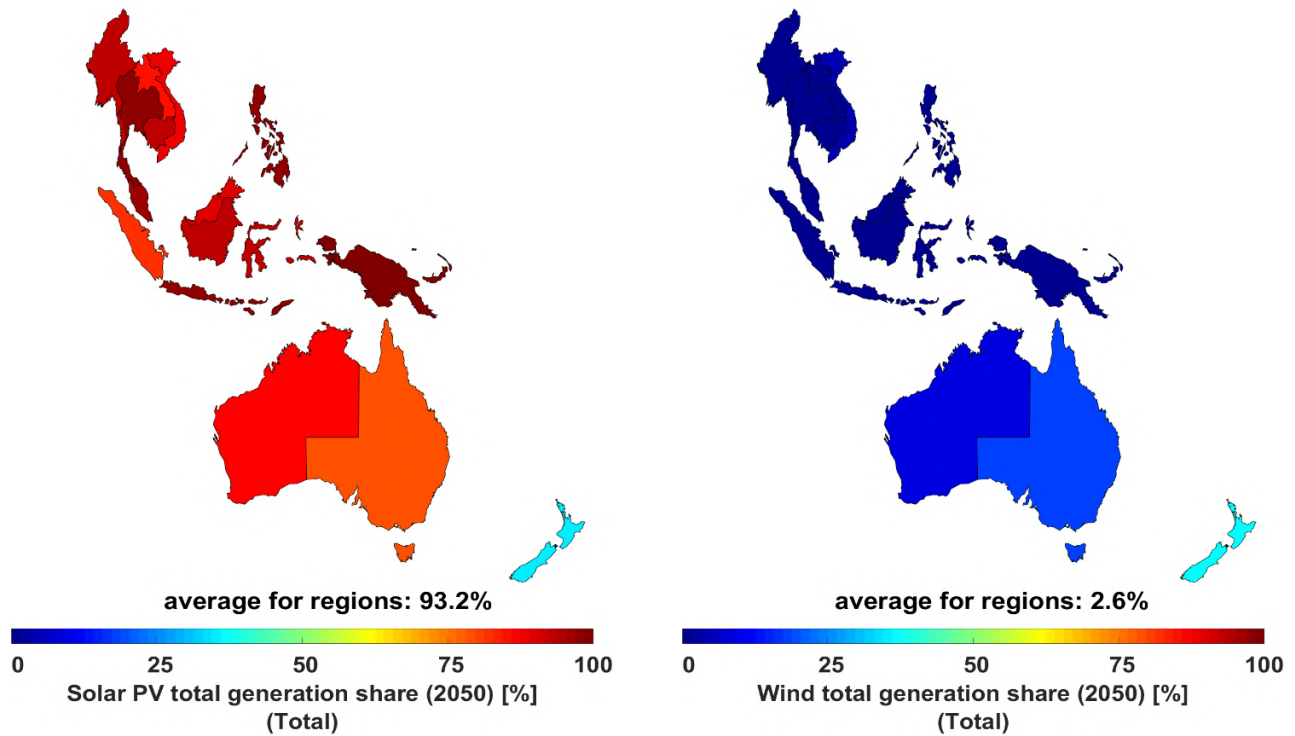
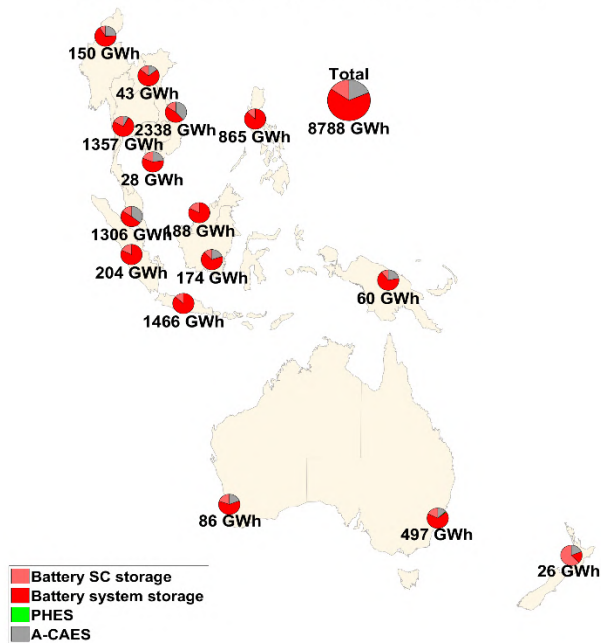

Figure 3.8-27: Southeast Asia – Regional variation of electricity generation shares of solar PV (left) and wind energy (right) in 2050.

Utility-scale and prosumer batteries contribute a major share of electricity storage capacities, with some shares of A-CAES by 2050, as shown in Figure 3.8-28. Storage capacities are well distributed across all parts of Southeast Asia, to complement higher shares of installed solar PV capacities. Batteries, both prosumers and utility-

scale, deliver the largest shares of output by 2050, with minor shares of A-CAES as shown in Figure 3.8-28. A higher share of prosumer batteries output is observed in New Zealand, wherein prosumer capacities are relatively higher that favours a decentralised energy transition.

Regional electricity storage capacities



Regional electricity storage annual generation

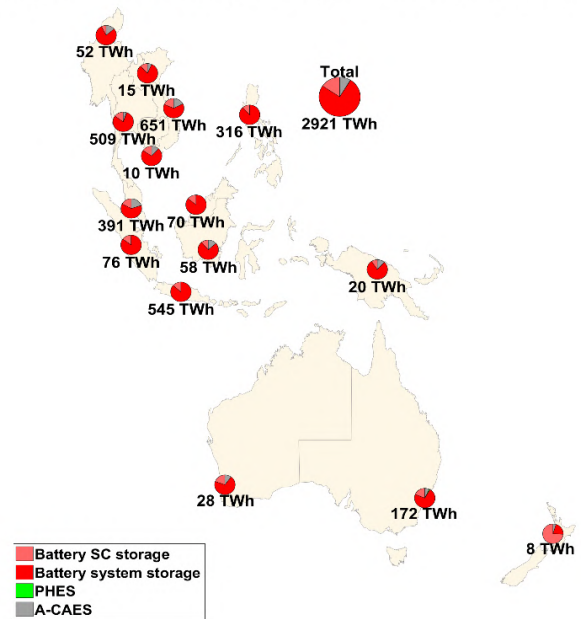

Figure 3.8-28: Southeast Asia – Regional electricity storage capacities (left) and electricity storage annual throughput (right) in 2050.

The storage output across the power, heat, transport, and desalination sectors of Southeast Asia is predominantly from batteries (both utility-scale and prosumers) and some synthetic natural gas supply in 2050, as shown in Figure 3.8-29. Batteries, which supply an average of 29.9% of the storage output across Southeast Asia, are well

distributed across all regions of Southeast Asia. Synthetic natural gas, which supplies an average of 0.2% of the total electricity demand across Southeast Asia, is spread across the region. This is complemented with a supply share of storage from biomethane of less than 0.1% in 2050 across Southeast Asia.

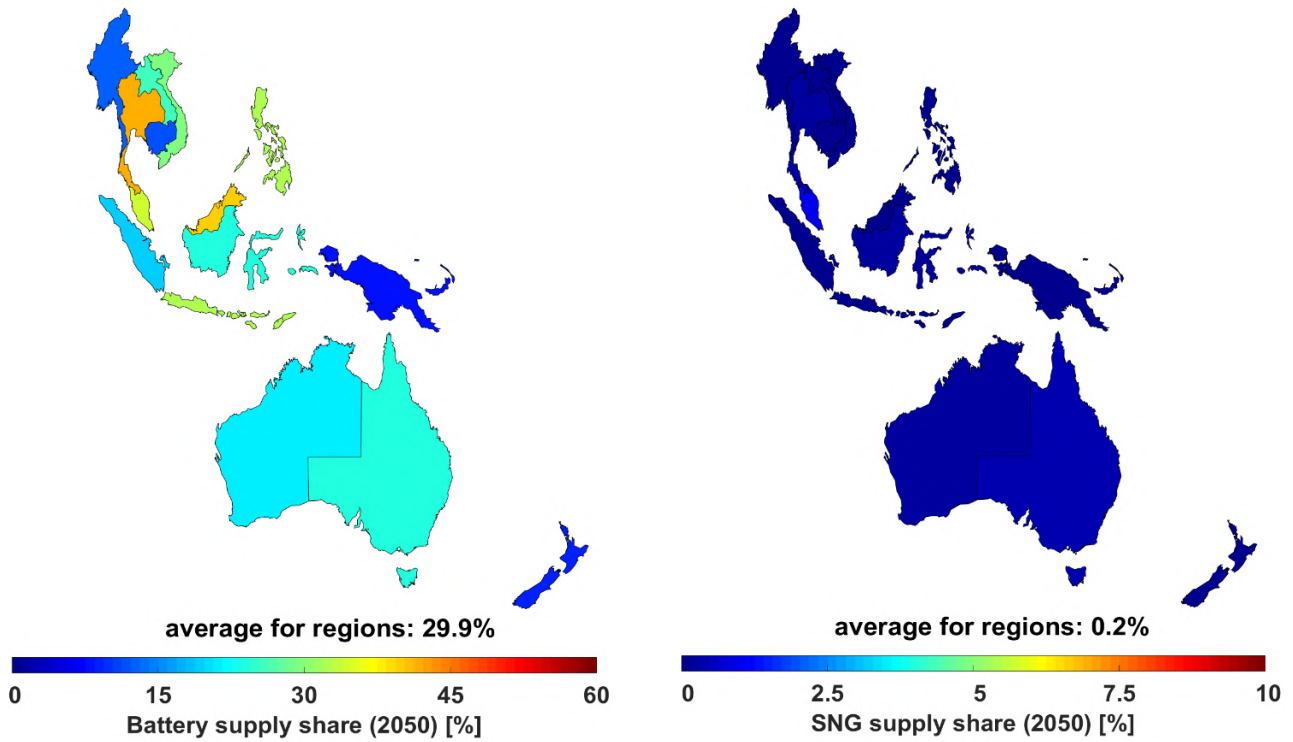

Figure 3.8-29: Southeast Asia – Regional variation of storage supply shares of batteries (left) and synthetic natural gas (right) in 2050.

Greenhouse Gas Emissions

The results of the global transition towards a 100% renewable energy system indicate a sharp decline in GHG emissions until 2050, reaching zero GHG emissions by 2050 across the power, heat, transport, and desalination sectors in Southeast Asia as shown in Figure 3.8-30. The power sector

undergoes a deep decarbonisation by 2030, whereas for the heat and transport sectors this occurs mostly between 2030 and 2050. Moreover, the remaining cumulative GHG emissions comprise around 24 GtCO_{2eq} from 2018 to 2050. Therefore, the energy transition pathway for Southeast Asia is in adherence to the ambitious Paris Agreement target of 1.5°C.

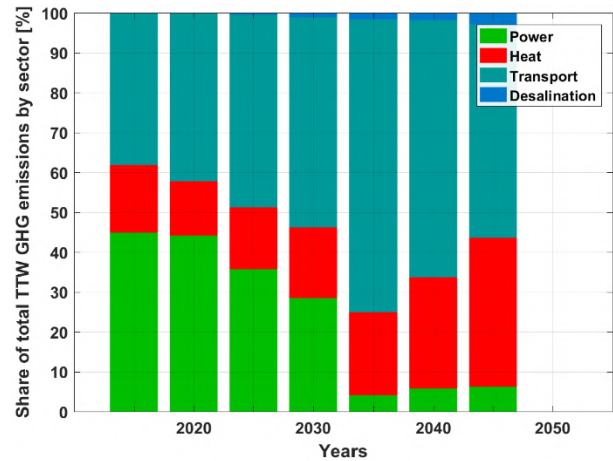
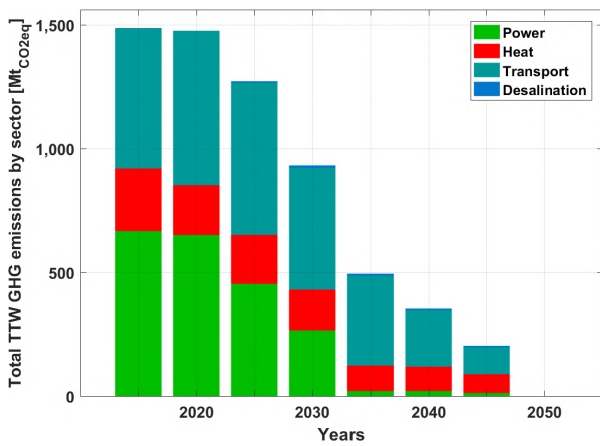

Figure 3.8-30: Southeast Asia – Sector-wise GHG emissions (left) and the share of GHG emissions of different sectors (right) during the energy transition from 2015 to 2050. Tank to Wheel (TTW) considers GHG emissions from readily available fuels and does not consider GHG emissions from the upstream production and delivery of fuels.

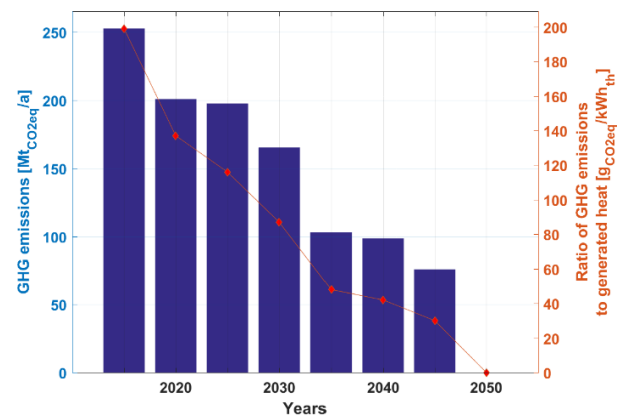
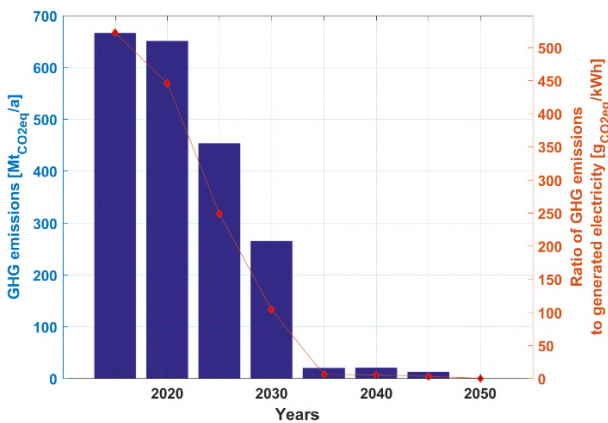

Figure 3.8-31: Southeast Asia – GHG emissions in the power sector (left) and GHG emissions in the heat sector (right) during the energy transition from 2015 to 2050.

GHG emissions from the power sector decline rapidly through the transition from around 650 MtCO₂ eq./a in 2015 to zero by 2050 as shown in Figure 3.8-31. Similarly, GHG emissions from the heat sector decline through the transition from over 250 MtCO₂ eq./a in 2015 to zero by 2050 as shown in Figure 3.8-31.

GHG emissions from the transport sector decline through the transition from around 620 MtCO₂ eq./a in 2020 to zero by 2050, as shown in Figure 3.8-32. Similarly, GHG emissions from the desalination sector that are much lower than those of other sectors, after initial increase, decline through the transition from over 10 MtCO₂ eq./a in 2030 to zero by 2050 as shown in Figure 3.8-32.

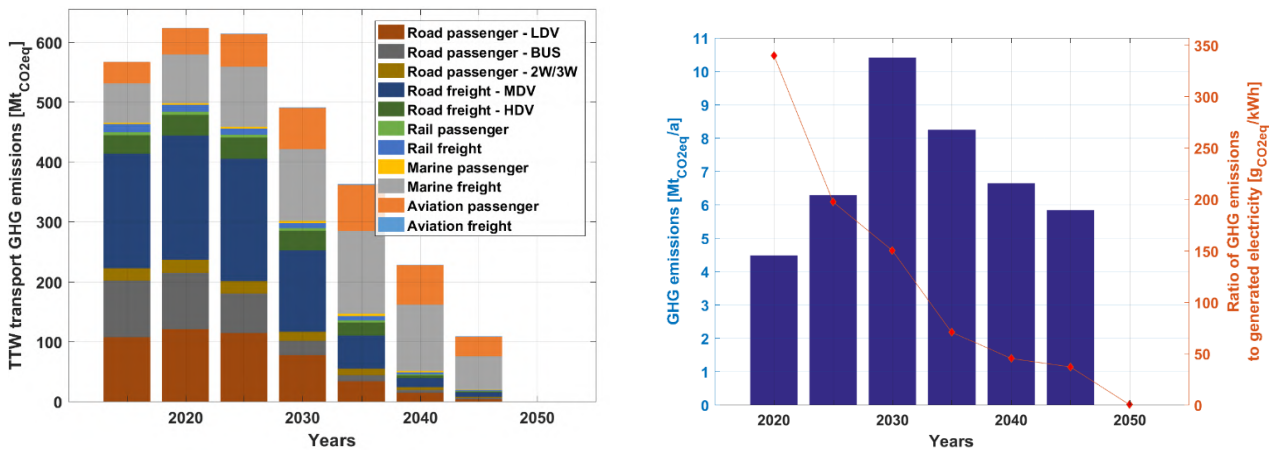

Figure 3.8-32: Southeast Asia – GHG emissions in the transport sector (left) and GHG emissions in the desalination sector (right) during the energy transition from 2015 to 2050. Tank to Wheel (TTW) considers GHG emissions from readily available fuels and does not consider GHG emissions from the upstream production and delivery of fuels.

Jobs in the Power sector across Southeast Asia

Solar PV and battery storage sectors create the major share of jobs through the transition period as shown in Figure 3.8-33. Biomass and hydropower create a higher share in the initial periods up to 2025, but continue to create some jobs through the transition period. While, wind power sector creates some jobs from 2020 to 2030 (96 thousand jobs in 2025), beyond which fewer jobs are created as solar PV becomes more cost effective and installations increase in share with 2.1 million jobs by 2050. The storage sector led by batteries create

a fair share of the jobs from 2030 onwards and continues through to 2050 with 414 thousand jobs in the battery sector by 2050. This could happen lot earlier as countries such as Australia are already witnessing both utility-scale as well as prosumer scale battery installations (AEC, 2018). On the contrary, jobs associated with coal and gas power generation are seen to decline rapidly. The total number of direct energy jobs increases significantly from around 1.2 million in 2015 to over 3.3 million in 2030, beyond which there is a decline to under 2.5 million by 2040, after which there is a steady increase up to around 3.2 million by 2050.

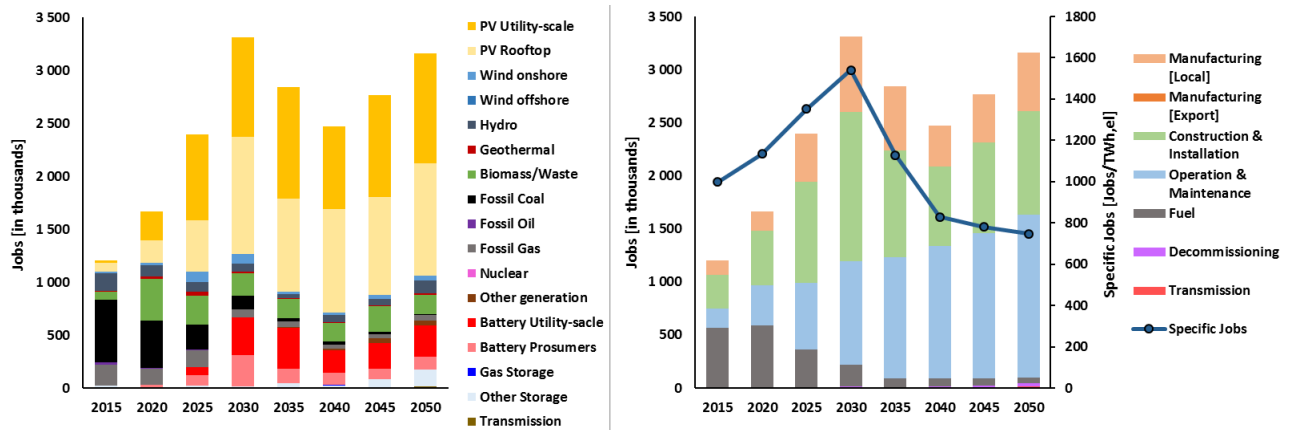

Figure 3.8-33: Southeast Asia – Jobs created by various power generation and storage technologies (left) and jobs created based on different categories with the development of electricity demand specific jobs (right) during the energy transition from 2015 to 2050.

With rapid installation of capacities up to 2030, the majority of jobs is created in the construction and installation of power generation technologies with 42% of total jobs by 2030. Manufacturing jobs have a relatively low share in the initial periods up to 2020 as the share of imports is relatively high. Beyond 2025 as domestic production capabilities build up, a high share of manufacturing jobs is observed until 2050 (from 21% of total jobs in 2035 to 17% of total jobs by 2050). The share of fuel related jobs continues to diminish from 2020 onwards through the transition period reaching just

2% of total jobs by 2050, as conventional power plants are replaced by renewable and storage technologies. By contrast, the share of operation and maintenance jobs continues to grow through the transition period with 49% of total jobs by 2050. The electricity demand specific jobs increases from 997 jobs/TWh_{el} in 2015 to 1541 jobs/TWh_{el} in 2030 with the rapid ramp up in renewable energy installations. Beyond 2030, it declines steadily to around 748 jobs/TWh_{el} by 2050, as highlighted in Figure 3.8-33.

3.9. North America

North America is comprised of the major economic centers of the world, USA, Canada and Mexico, with a 27% share in present global GDP ⁶³, and is one of the largest energy consumption centers across the world. Population in North America is 477 million in 2015 representing a share of 7% in world population, which is estimated to be 6% in 2050. North America, led by some of the states in the USA such as California, North Carolina and Arizona, among others, have been at the forefront of the energy transition with significant contributions towards developing renewable energy. Canada is one of the leading countries in the production and consumption of renewable energy. In the power sector, hydropower is the largest renewable energy source, accounting for about 62% of electricity generation. Combined with other renewable energy sources that have contributed to electricity generation by 5%, renewable energy provided around 67% of total

generated electricity in the country in 2016 ⁷⁵. Several Canadian cities have planned to move towards 100% renewable energy, including Alberta, British Columbia, Ontario and Saskatchewan ⁷⁶. In addition, Mexico has a target to increase the share of renewable energy by 50% in the power sector by 2050 ⁷⁷. The detailed results for the energy transition across North America are available in a supplementary data file, the link for the file can be found in the Appendix.

Penetration of renewables is not just a matter of replacing hydrocarbons with zero-carbon sources of energy supply – it also represents a significant change in resource efficiency. This is illustrated by the overall electrification across the power, heat, transport, and desalination sectors as shown in Figure 3.9-1.

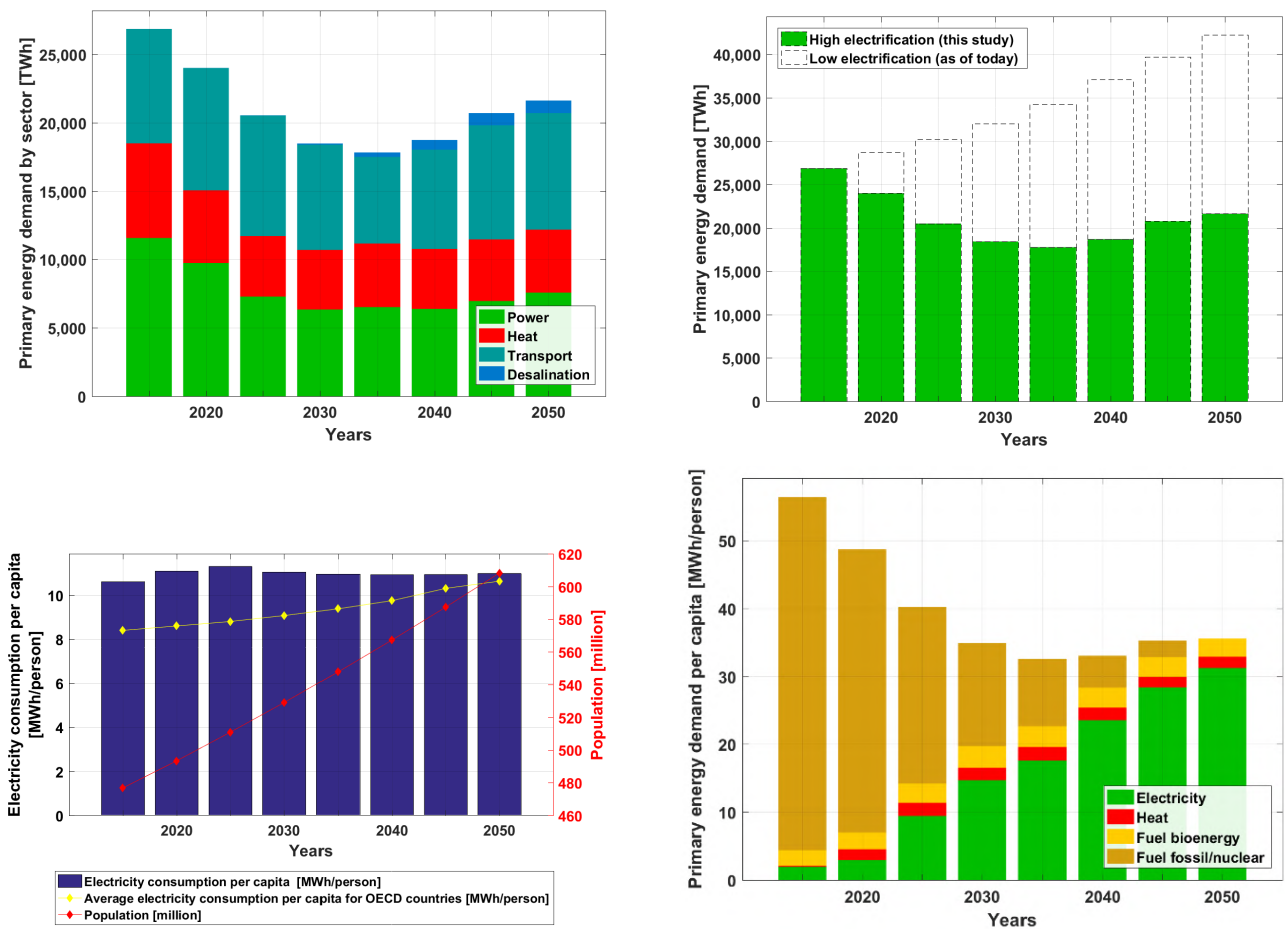

Figure 3.9-1: North America – Primary energy demand sector-wise (top left), efficiency gain in primary energy demand (top right), electricity consumption per capita with population (bottom left) and primary energy demand per capita (bottom right) during the energy transition from 2015 to 2050.

The primary energy demand assuming high electrification, which is the basis for this study, decreases from 28,000 TWh in 2015 to around 17,000 TWh by 2035 and increases up to 22,000 TWh by 2050 as shown in Figure 3.9-1. On the contrary, with low shares of electrification resulting from the adoption of current practices until 2050, the primary energy demand would reach nearly 42,000 TWh by 2050. This massive gain in energy efficiency is primarily due to a high level of electrification of more than 88% resulting in reduction of around 20,000 TWh by 2050, in comparison to the continuation of current practices with low shares of electrification. The population across North America is expected to grow from 477 to 608 million by 2050. Correspondingly, the average per capita energy demand decreases from around 60 MWh/person in 2015 to 31 MWh/person by 2035 and increases up to nearly 35 MWh/person by 2050. Additionally, a substantial demand from fuel conversion technologies arises beyond 2040, in

producing renewable-based fuels for the transport sector across North America.

Energy Supply

The electricity generation capacity across North America satisfies demand from all energy sectors including power, heat, transport and desalination. The total installed capacity grows massively from over 5300 GW in 2015 to about 19,000 GW by 2050 as shown in Figure 3.9-2. In the initial period of the transition, a larger share of wind capacities are installed up to 2030 reaching around 1770 GW by 2050, but in the later part of the transition solar PV dominates the shares of installed capacities reaching over 7020 GW by 2050. On the other hand, the shares of fossil fuels and nuclear decline through the transition to zero by 2050. Some shares of gas remain, but the fuel switches from fossil-based gas to synthetic natural gas produced with renewable electricity and biomethane.

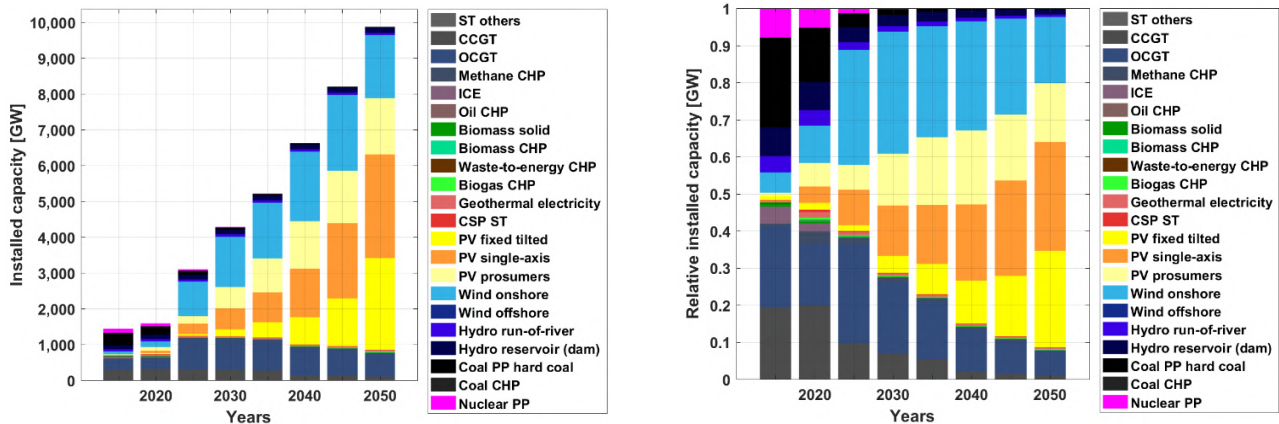

Figure 3.9-2: North America – Technology-wise installed capacities (left) and technology-wise shares of installed capacities (right) during the energy transition from 2015 to 2050.

Electricity generation from the various technologies to cover the demand of power, heat, transport, and desalination sectors is shown in Figure 3.9-3. Solar PV supply increases through the transition from 26% in 2030 to about 62% by 2050, becoming the lowest cost energy source. The share of wind energy increases to 55% by 2030 and contributes a stable share of the mix, but decline to 28% by 2050. In the heat sector, heat pumps play a significant role through the transition with a share of nearly 50% of heat generation by 2050 on both

the district and individual levels, as indicated in Figure 3.9-3. On the other hand, gas-based heating decreases through the transition from over 84% in 2015, to around 8% by 2050, wherein fossil-gas is eliminated and replaced by synthetic gas produced from renewables. Additionally, fossil fuel-based heating decreases through the transition period, as coal-based CHP and DH is replaced by electric heating, solar thermal, waste-to-energy CHP, biomass-based DH and IH and geothermal energy.

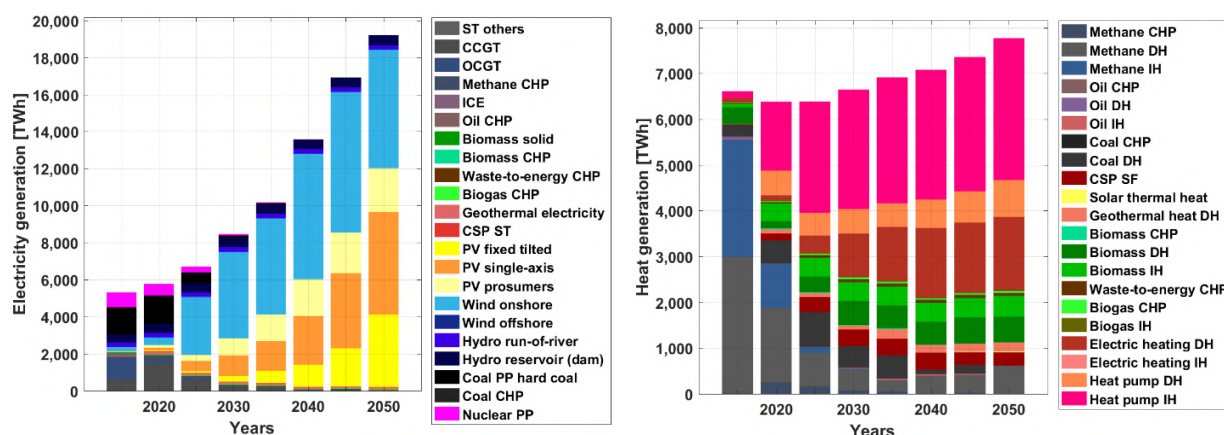

Figure 3.9-3: North America – Technology-wise electricity generation (left) and technology-wise heat generation (right) during the energy transition from 2015 to 2050.

Energy Storage

Energy storage technologies play a critical role in enabling a secure energy supply throughout North America, fully based on renewable energy across the different sectors. As highlighted in Figure 3.9-4, storage output covers almost 3500 TWh_{el} of total electricity demand in 2050. The ratio of electricity demand covered by energy storage to electricity generation increases significantly to around 12% by 2035 and remains around 11-12% until 2045,

thereafter in the last five-year period it increases to around 18% by 2050. Additionally, 4% is covered by heat storage conversion to electricity by 2050. Batteries emerge as the most relevant electricity storage technology contributing about 93% of the total electricity storage output by 2050. Additionally, a significant share of gas storage is installed to provide seasonal storage primarily during the cold winter season across North America.

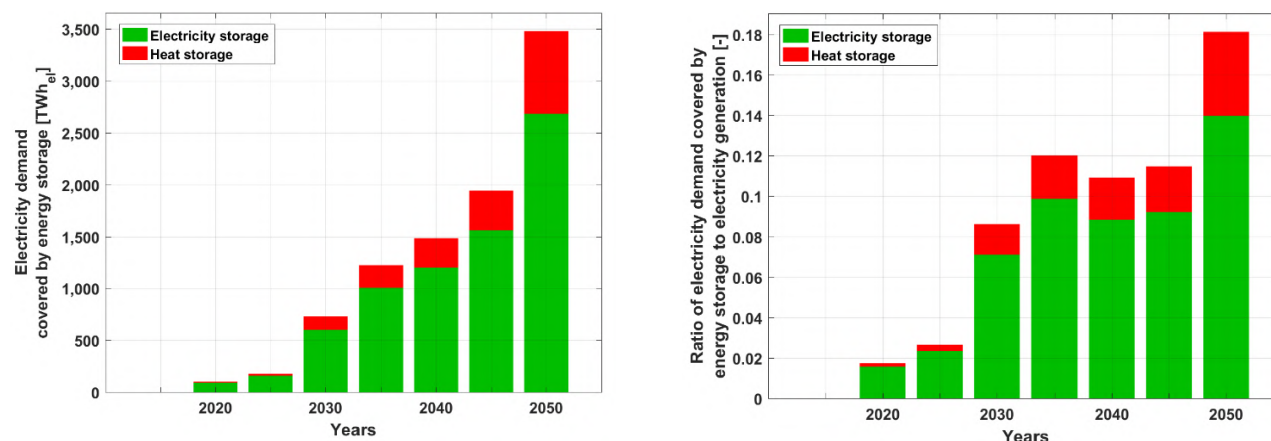

Figure 3.9-4: North America – Electricity demand covered by energy storage (left) and ratio of electricity demand covered by different forms of energy storage (right) during the energy transition from 2015 to 2050.

Similarly, heat storage plays a vital role in ensuring heat demand is covered across all the sectors. As indicated in Figure 3.9-5, storage output covers almost 1500 TWh_{th} of the total heat demand in 2050 and heat storage technologies are crucial to meet this demand. The ratio of heat demand covered by energy storage to heat generation increases substantially to over 16% by 2050, also shown in Figure 3.9-5. Thermal energy storage

(TES) emerges as the most relevant heat storage technology with around 58% of heat storage output by 2050. Furthermore, power-to-gas (PtG) contributes around 42% of heat storage output in 2050. As fossil fuels usage for heat generation is completely eliminated in the final five-year period from 2045-2050, there is an increase in heat storage utilisation, with minor shares from electricity to heat conversion.

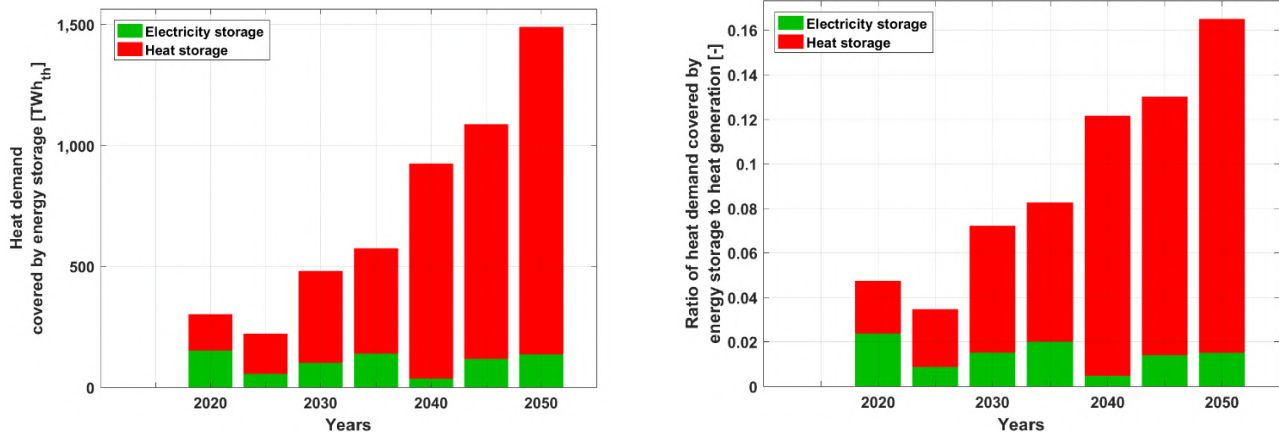

Figure 3.9-5: North America – Heat demand covered by energy storage (left) and the ratio of heat demand covered by different forms of energy storage (right) during the energy transition from 2015 to 2050.

Costs and Investments

The total annual system costs are in the range of 1,000-1,200 b€ through the transition period and are well distributed across the major sectors of power, heat, and transport, as desalination demand across North America is relatively low as compared to other regions of the world. In addition, as indicated in Figure 3.9-6, CAPEX increases through

the transition, as the share of fuel costs continue to decline. The steady increase in CAPEX-related energy system costs indicate that fossil fuels imports and the respective negative impacts on trade balances and foreign policies will fade out through the transition. In addition, lower fossil fuels import dependency will lead to higher levels of energy security and diversification across North America.

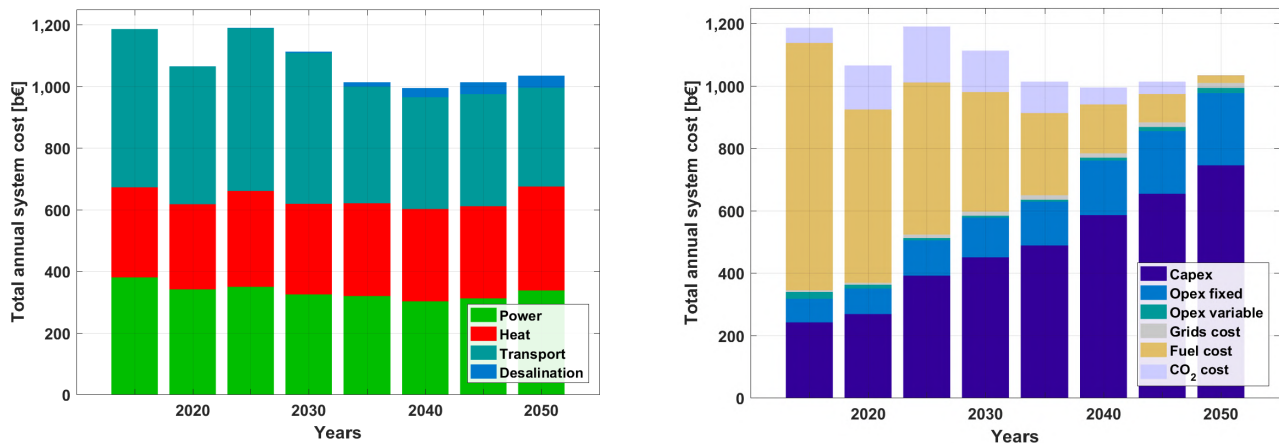

Figure 3.9-6: North America – Annual system costs, sector-wise (left) and functionality-wise (right) during the energy transition from 2015 to 2050.

As increasing shares of power generation capacities are added across North America, renewable energy sources become the least costing power generation sources⁶⁶. As indicated in Figure 3.9-7, levelised cost of energy declines from around 65 €/MWh in 2015 to around 53 €/MWh by 2050. Furthermore, the LCOE is increasingly dominated by capital costs as fuel costs continue to decline through the transition period, which could mean

increased self-reliance in terms of energy for North America by 2050, as mentioned earlier. Capital costs are well spread across a range of technologies with major investments for PV, wind energy, batteries, heat pumps, and synthetic fuel conversion up to 2050, as shown in Figure 3.9-7. The cumulative investments are about 10,200 b€ through the transition from 2016-2050.

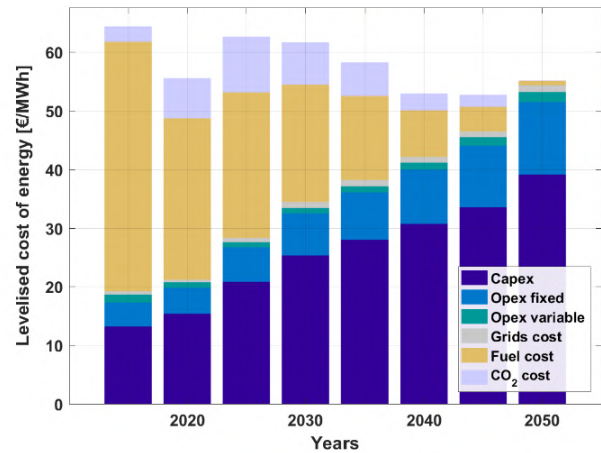
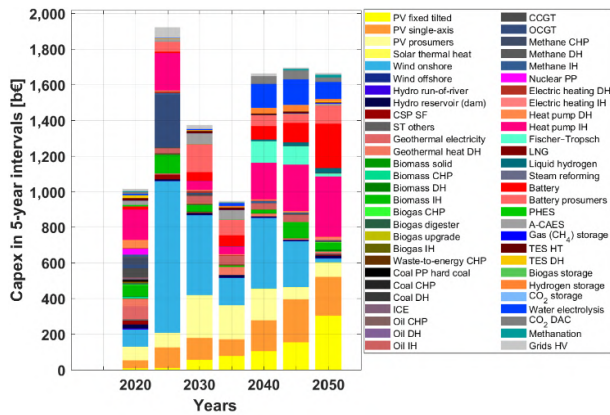

Figure 3.9-7: North America – Capital costs for five-year intervals (left) and levelised cost of energy (right) during the energy transition from 2015 to 2050.

Outlook across Sectors

Different trends in the power, heat, transport, and desalination sectors across North America emerge through the transition. As the sectors transition towards having higher shares of renewable energy, different technologies have vital roles in ensuring the stability of the energy system. A closer look at the individual sectors provides further insights into the energy transition across North America towards 100% renewable energy.

Power and Heat

The total installed power generation capacity increases from nearly 1,500 GW in 2015 to around

5,500 GW by 2050, as shown in Figure 3.9-8. Across the power sector, solar PV with 3,900 GW and wind with 800 GW constitute the majority of installed capacities by 2050 along with some shares of hydropower and gas-based power generation. In the heat sector, heat pumps, electric heating, and biomass-based heating constitute the majority of installed capacities by 2050, also shown in Figure 3.9-8. A significant increase in installed capacities of heat pumps, electric heating and biomass-based heating occurs in the final five-year period leading up to 2050, as fossil fuels are completely eliminated from the energy system.

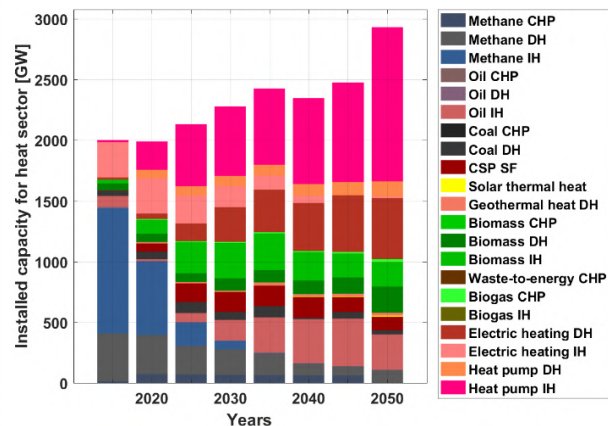
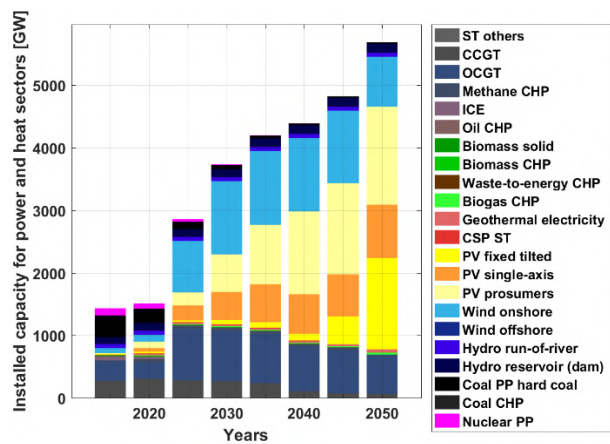

Figure 3.9-8: North America – Technology-wise installed capacities for power (left) and heat (right) during the energy transition from 2015 to 2050.

The transition across North America results in a power and heat sector dominated by fossil fuels and nuclear in 2015 moving towards a solar PV and wind energy dominated sector by 2050, with some hydropower and bioenergy as shown in Figure 3.9-9. The primary electricity generation increases from around 5,250 TWh in 2015 to around 10,000 TWh

by 2050, which is primarily from PV and wind. Heat generation increases from around 6,600 TWh in 2015 to around 7,700 TWh by 2050, which is predominantly from heat pumps and electric heating with some biomass-based heating and solar thermal, also shown in Figure 3.9-9.

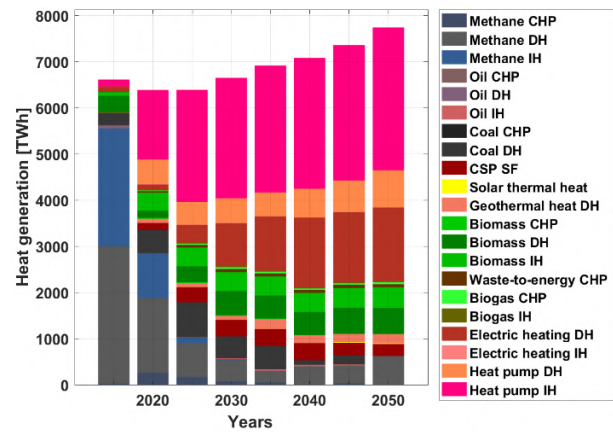
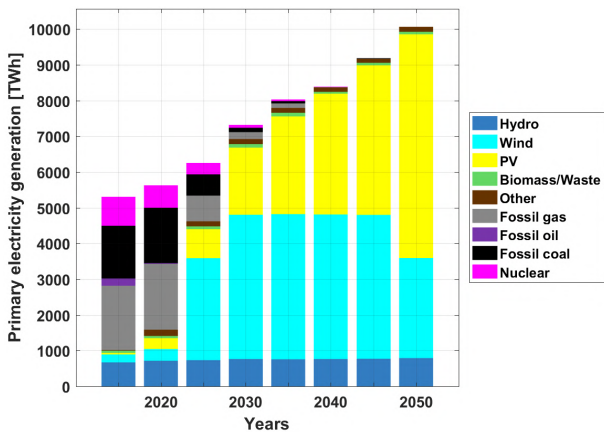

Figure 3.9-9: North America – Primary electricity generation (left) and technology-wise heat generation (right) during the energy transition from 2015 to 2050.

The installed electricity storage capacities increase from just 0.1 TWh in 2015 to around 7.7 TWh by 2050, as shown in Figure 3.9-10. Utility-scale and prosumer batteries with some shares of A-CAES and PHES are installed through the transition. The installed capacities of A-CAES are also a consequence of the modelling approach, which

prioritises full domestic energy supply for all North American regions. The installed heat storage increases gradually to around 57 TWh by 2050, as shown in Figure 3.9-10. This substantial capacities of gas storage addition is mainly to provide seasonal storage across North America covering the heat demand in the absence of fossil fuels.

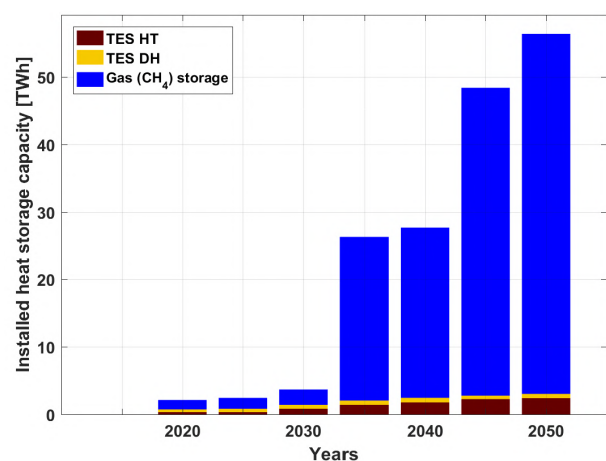
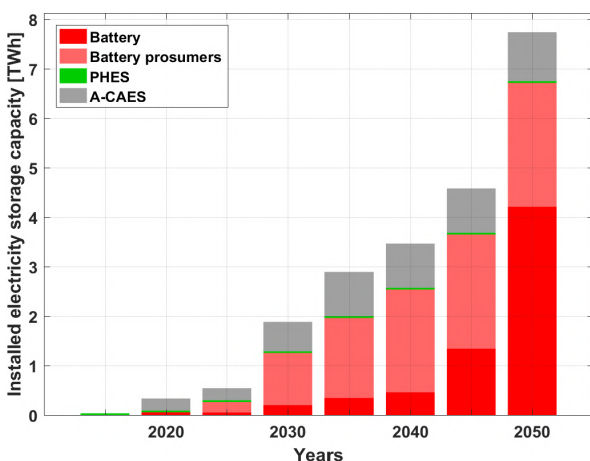

Figure 3.9-10: North America – Installed electricity storage capacities (left) and heat storage capacities (right) during the energy transition from 2015 to 2050.

Utility-scale and prosumer batteries contribute a major share of electricity storage output with nearly 2,800 TWh_{el} by 2050, as highlighted by Figure 3.9-11. In addition, A-CAES contributes through the transition. TES emerges as the most relevant heat

storage technology with around 58% of heat storage output by 2050, also seen in Figure 3.9-11. Gas storage contributes around 42% of the heat storage output in 2050 covering predominantly seasonal demand, previously covered by fossil gas.

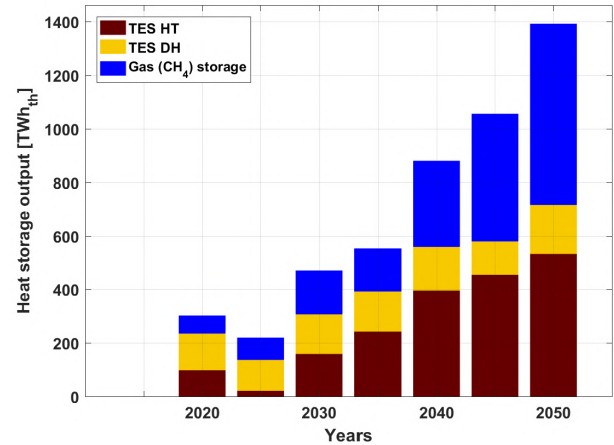
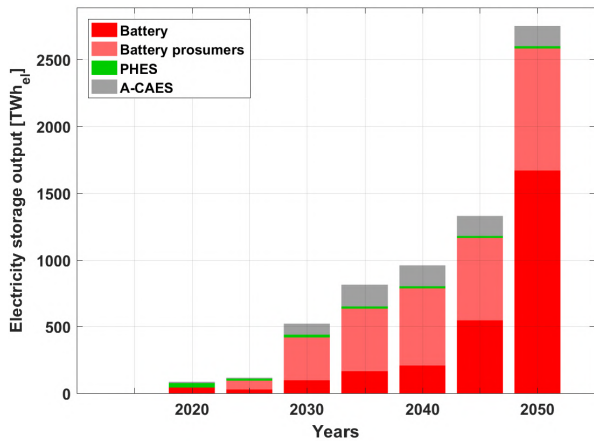

Figure 3.9-11: North America – Electricity storage output (left) and heat storage output (right) during the energy transition from 2015 to 2050.

LCOE of the power sector decreases substantially from over 80 €/MWh in 2015 to around 54 €/MWh by 2050, as shown in Figure 3.9-12. LCOE is predominantly comprised of CAPEX as fuel costs decline through the transition. Whereas, LCOH of the heat sector after declining through the transition, increases marginally from around 54 €/MWh in 2015 to around 56 €/MWh by 2050, as

shown in Figure 3.9-12. LCOH is predominantly comprised of CAPEX as fuel costs decline through the transition. Despite a substantial increase in heat demand across North America, mainly driven by industrial process heat and increased space heating, the LCOH remains quite stable up to 2050.

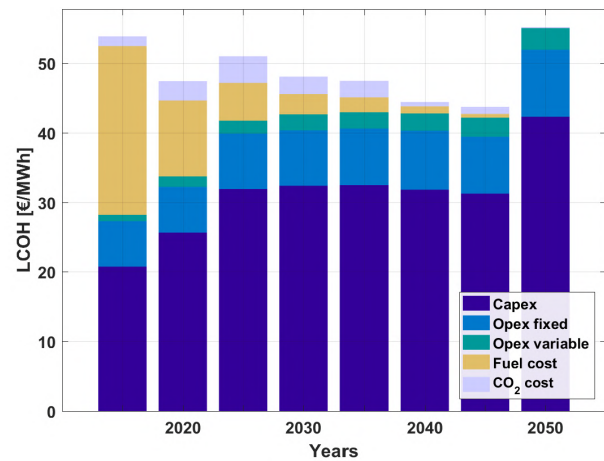
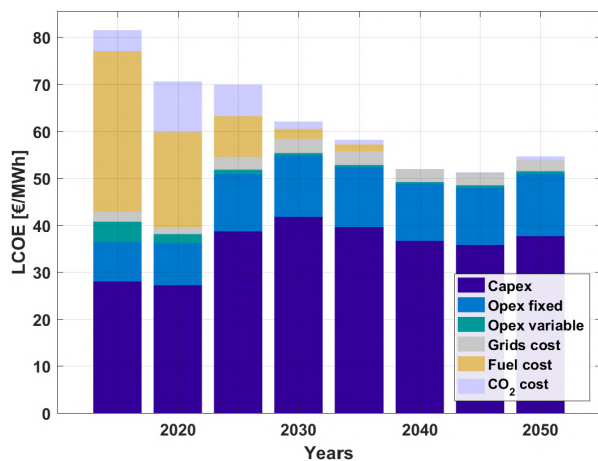

Figure 3.9-12: North America – Levelised cost of electricity (left) and levelised cost of heat (right) during the energy transition from 2015 to 2050.

Investments are well spread across a range of power generation technologies with the majority share in wind energy up to 2030, beyond which solar PV dominates investments up to 2050, as shown in Figure 3.9-13. Investments in the heat sector are mainly in heat pumps and some shares in

biomass heating up to 2050, also shown in Figure 3.9-13. The steep increase in heat pump investments in the final years of the transition until 2050 is mainly to cover the heat demand in the absence of fossil fuels as well as the lower costs of heat pumps by 2050.

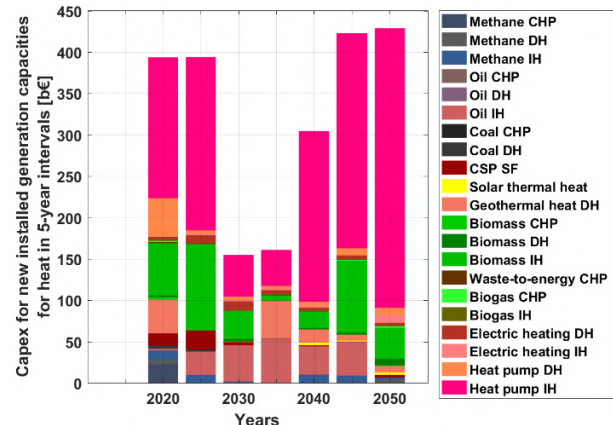
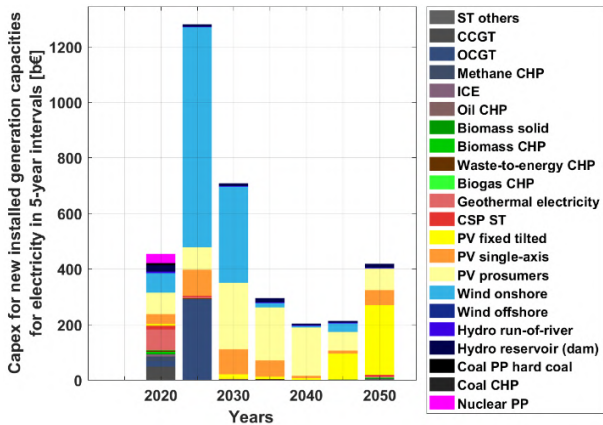

Figure 3.9-13: North America – Capital costs of installed generation capacities in five-year intervals for electricity (left) and heat (right) during the energy transition from 2015 to 2050.

Transport

The primary energy demand of the transport sector across North America is much higher than the energy demand from the power sector at around 8,200 TWh in 2015. However, this demand declines through the transition to around 5,300 TWh by 2050, mainly due to the efficiency gains brought about by electrification of the sector as shown in Figure 3.9-14. On the contrary, fossil fuels consumption in the transport sector across North America is seen to decline through the transition

from about 97% in 2015 to zero by 2050. While, liquid fuels produced by renewable electricity contribute around 37% of final energy demand in 2050. In addition, hydrogen constitutes more than 28% of final energy demand in 2050. Sustainably produced biofuels contribute a minor share to enable a complete elimination of fossil fuel usage in the transport sector. Electrification of the transport sector creates an electricity demand of almost 8,000 TWh_{el} by 2050. The massive demand for liquid fuels kicks in from 2040 onwards up until 2050, as indicated in Figure 3.9-14.

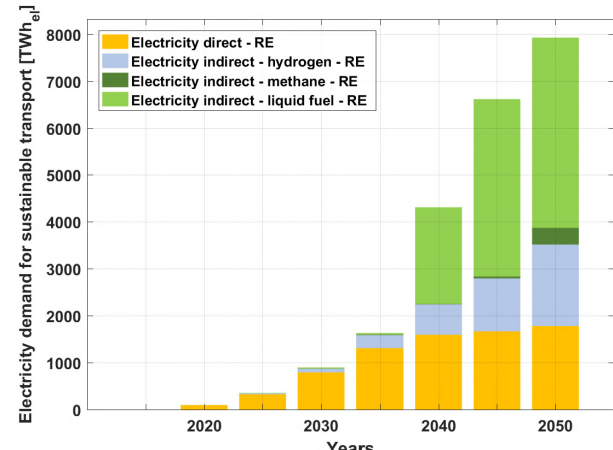
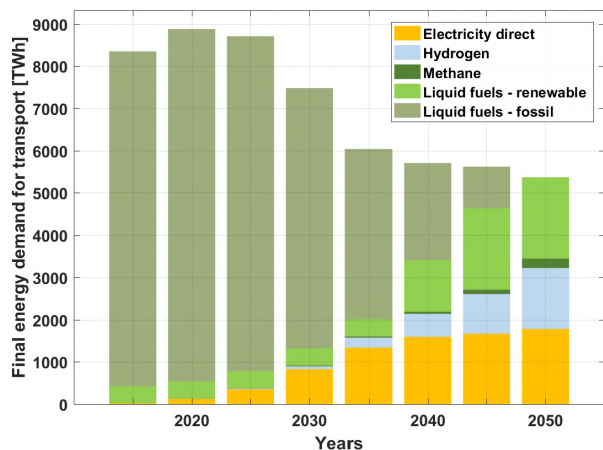

Figure 3.9-14: North America – Final energy demand for transport (left) and electricity demand for sustainable transport (right) during the energy transition from 2015 to 2050.

Installed power generation capacities for the transport sector increase substantially through the transition to around 3,750 GW by 2050, as shown in Figure 3.9-15. Solar PV and wind form the majority share of the power generation capacities for the transport sector, as they are the least

costing energy sources by 2050. Similarly, electricity generation increases substantially up to over 8,100 TWh by 2050 also to be seen in Figure 3.9-15. Solar PV and wind energy generate all the electricity required to meet the demand of the transport sector in 2050.

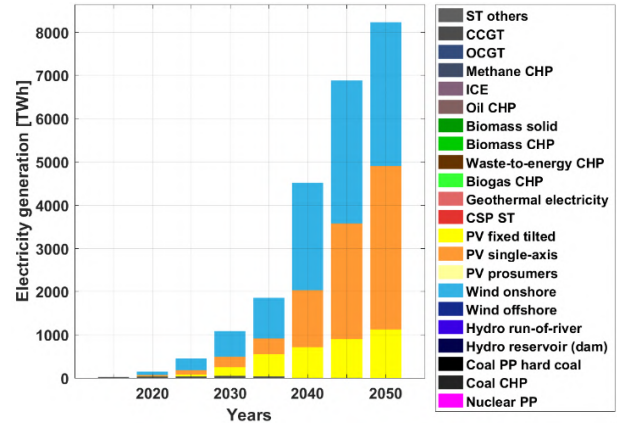
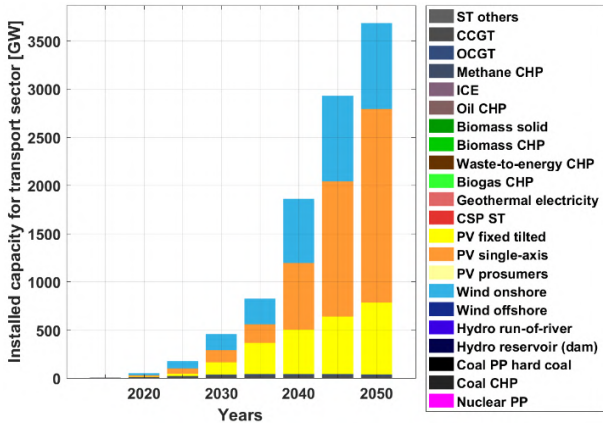

Figure 3.9-15: North America – Transport sector installed power generation capacity (left) and electricity generation (right) during the energy transition from 2015 to 2050.

A critical aspect to complement the electrification of the transport sector is the installation of storage technologies. As seen in Figure 3.9-16, the installed capacities of electricity storage increase through the transition to around 1.8 TWh by 2050. The majority of installed capacities are A-CAES and utility-scale batteries. Similarly, electricity storage output increases through the transition to over 400 TWh_{el} by 2050 as shown in Figure 3.9-16. Utility-

scale batteries play a vital role as they contribute a major portion of the output through the transition, with over 280 TWh_{el} by 2050. The relatively low electricity storage of less than 5% of generated electricity for the transport sector is enabled by the flexible operation of batteries, water electrolyser units, and hydrogen buffer storage for synthetic fuel production.

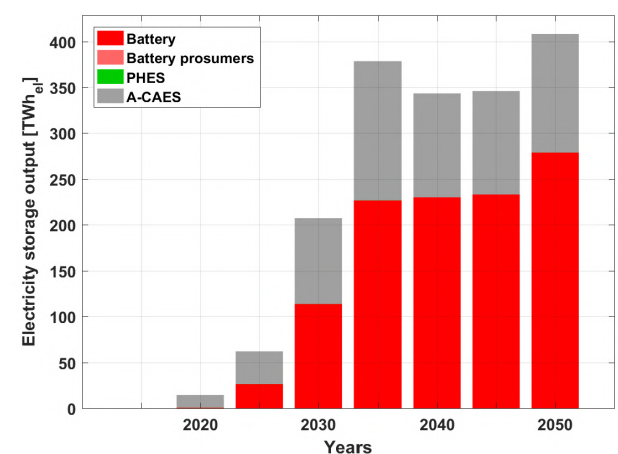
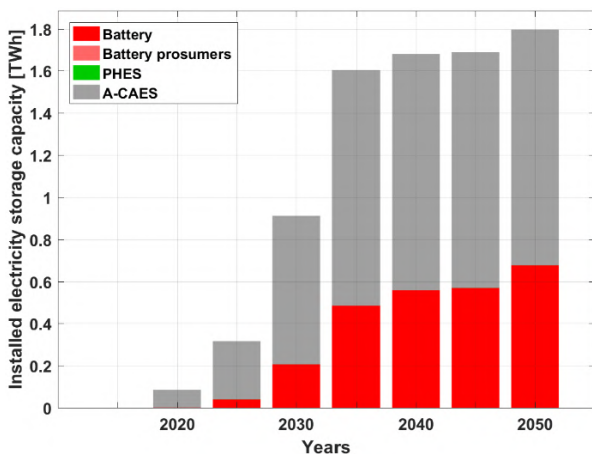

Figure 3.9-16: North America – Transport sector installed electricity storage capacity (left) and electricity storage output (right) during the energy transition from 2015 to 2050.

An essential aspect in the transition of the transport sector towards higher electrification completely based on renewable energy is the production of synthetic fuels, hydrogen and sustainable biofuels. As indicated in Figure 3.9-17, the installed capacities of fuel conversion technologies increase substantially from 2040 onwards to almost 2,000 GW by 2050. Water electrolysis forms the majority

share of fuel conversion capacities through the transition. Additionally, heat is needed during the production of synthetic fuels, mainly for energy-efficient CO₂ direct air capture, and this is enabled by managing process heat, which is otherwise not useable. Heat utilisation is in the range of 1,100 TWh_{th} by 2050, which is comprised of excess heat and recovered heat, as shown in Figure 3.9-17.

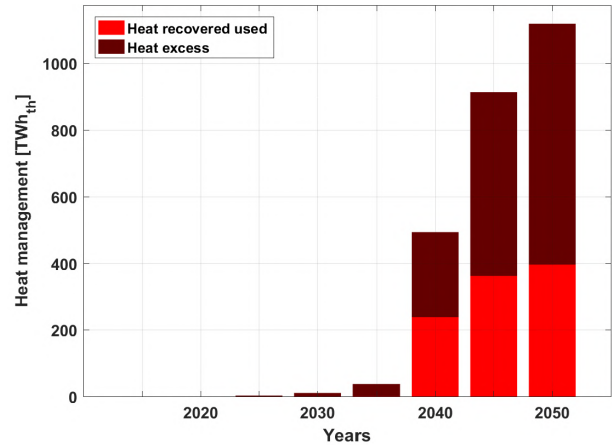
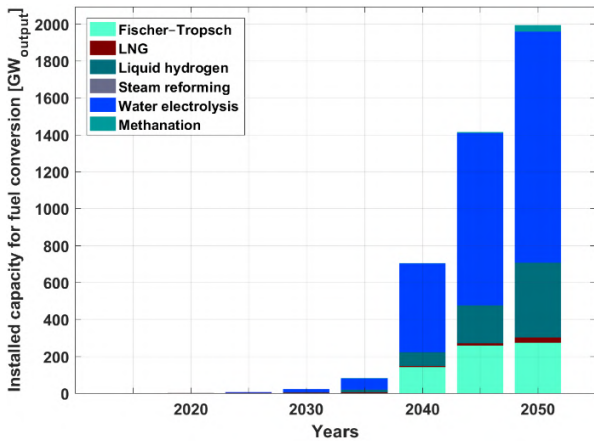

Figure 3.9-17: North America – Transport sector installed capacity for fuel conversion (left) and heat management (right) during the energy transition from 2015 to 2050.

Similarly, gas storage is necessary in the production of synthetic fuels. As shown in Figure 3.9-18, the installed storage capacities for gas increases through the transition to around 20 TWh by 2050. Hydrogen storage is the major gas stored through the transition, while the share of methane gas increases in 2050 reaching almost half of the total installed storage capacities. CO₂ storage and CO₂ direct air capture, which are vital in the production

of synthetic fuels, are installed from 2040 onwards. The installed capacities for CO₂ storage and CO₂ direct air capture increase up to around 380 MtCO₂ by 2050, as shown in Figure 3.9-18. The major share of installed storage capacity is CO₂ direct air capture, which is on an annual basis as compared to CO₂ storage. Despite having a lower storage capacity, CO₂ storage has a substantial utilisation and correspondingly higher throughput.

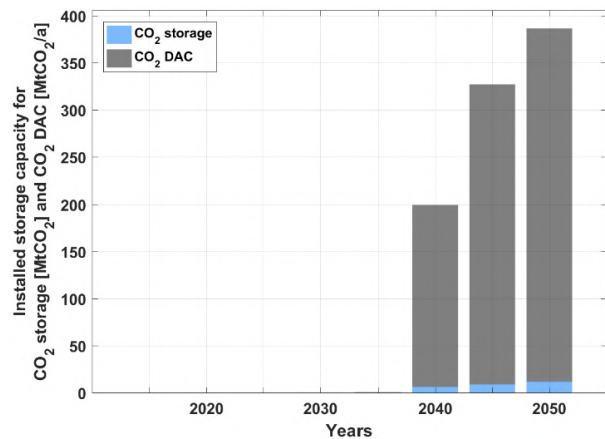
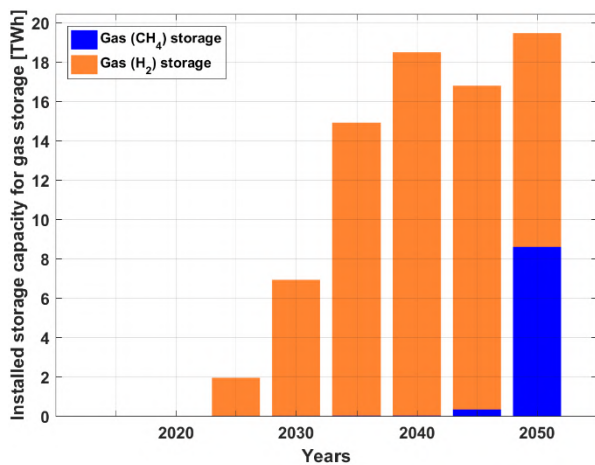

Figure 3.9-18: North America – Transport sector installed capacity for gas (methane and hydrogen) storage (left) and CO₂ direct air capture and CO₂ storage (right) during the energy transition from 2015 to 2050.

Fuel costs are a deciding factor in the overall energy mix for the transport sector across North America and their developing trends are highlighted in Figure 3.9-19. FT and SNG fuel costs decline through the transition up to 2050 and FT fuels are cost competitive with fossil liquid fuels including GHG emissions costs, at around 80 €/MWh in 2050. In addition, SNG is more cost effective than LNG in 2050. Electricity emerges as the most cost effective option with LCOE primary

around 16 €/MWh and along with complementary costs of storage and other system components, total LCOE is around 26 €/MWh in 2050. H₂ fuel costs decline to be more cost competitive than fossil fuels, in the range of 46 €/MWh in 2050, while liquid H₂ is in the range of 52 €/MWh. CO₂ from DAC is a critical component for synthetic fuels at around 31 €/tCO_{2e} in 2050, using waste heat, as shown in Figure 3.9-19.

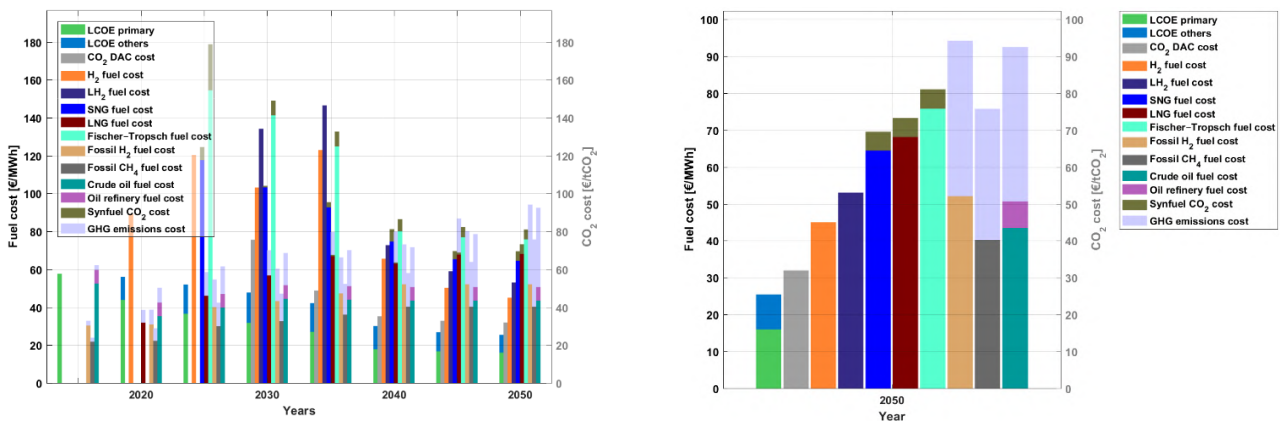

Figure 3.9-19: North America – Fuel costs for the transport sector during the energy transition from 2015 to 2050 (left) and fuel costs in 2050 (right).

The final energy costs for transport are in the range of 280-550 b€ through the transition period with a decline from around 510 b€ in 2015 to about 280 b€ by 2050, as shown in Figure 3.9-20. Furthermore, annual system costs transit from being heavily dominated by fuel costs in 2015 to a very diverse share of costs across various technologies for electricity, synthetic fuels and sustainable biofuel production by 2050, as

highlighted in Figure 3.9-20. The difference in annual final transport energy and system costs is predominantly due to additional aspects of the system beyond 2040, as FT units produce naphtha as a by-product, that adds to the overall system costs. The cost for naphtha is allocated to the industry sector as input for the chemical industry, since it is a valuable feedstock.

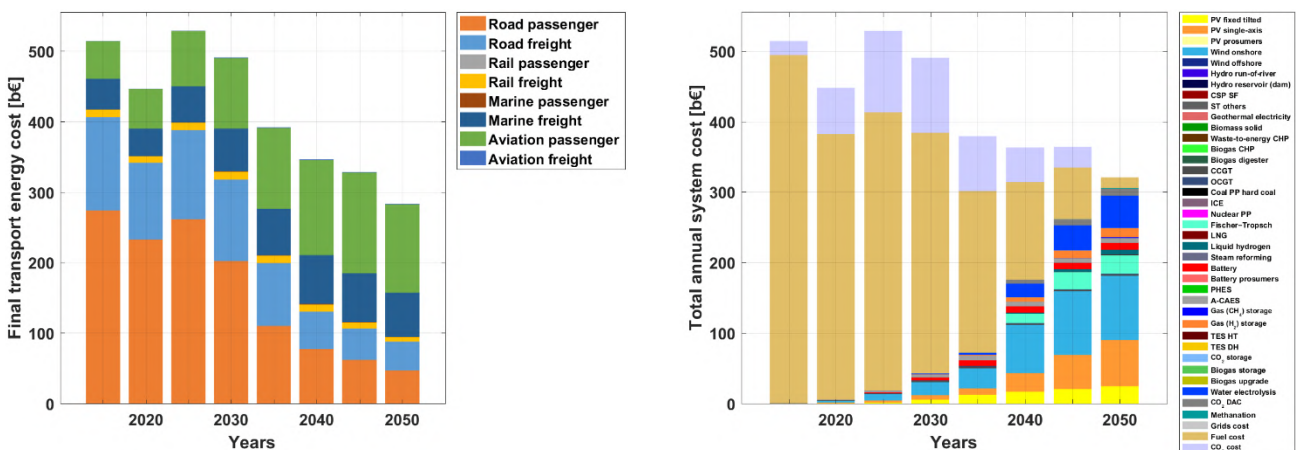

Figure 3.9-20: North America – Final transport energy costs based on mode of transport (left) and source of energy (right) during the energy transition from 2015 to 2050.

The final transport passenger costs decline from around 0.11 €/p-km in 2015 to 0.05 €/p-km by 2050, as shown in Figure 3.9-21. Final transport passenger costs decline for road transport through the transition, whereas for marine and aviation there is a marginal decrease. Similarly, final

transport freight costs decline from around 0.065 €/t-km in 2015 to 0.02 €/t-km by 2050, as shown in Figure 3.9-21. The final freight costs in the case of road declines through the transition, whereas it remains stable for rail, aviation and marine.

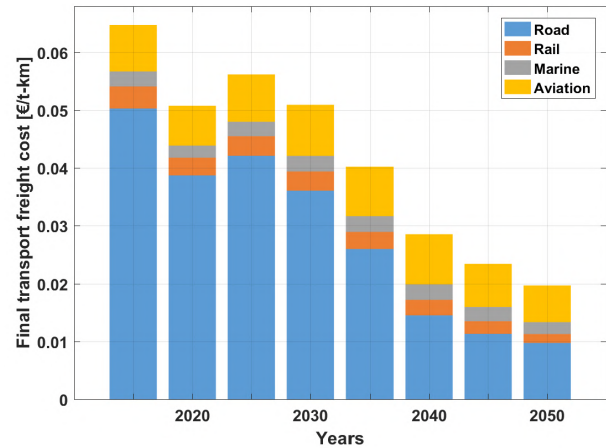
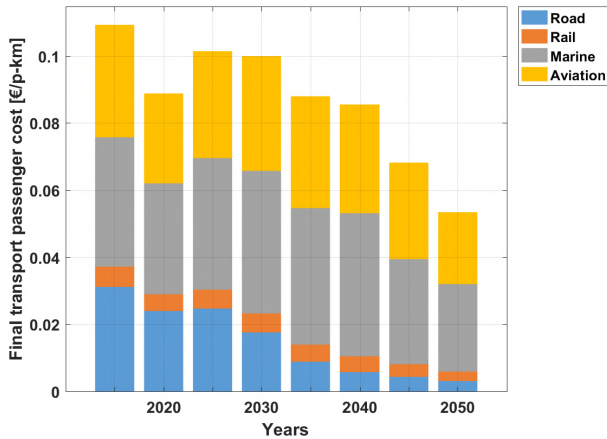

Figure 3.9-21: North America – Final transport passenger cost (left) and final transport freight cost (right) during the energy transition from 2015 to 2050.

Desalination

The desalination demand in North America is lower in the initial periods of the transition, however the demand for desalinated water grows from 2030 onwards to among the highest in the world by 2050. Therefore, the installed capacities of power generation for the desalination sector increase from

around 5 GW in 2025 to around 520 GW by 2050 as shown in Figure 3.9-22. Solar PV and wind comprise the majority of installed capacities from 2030 until 2050. Primary electricity generation to meet the desalination demand is mainly from PV and wind with minor shares from fossil gas until 2045, as highlighted in Figure 3.9-22.

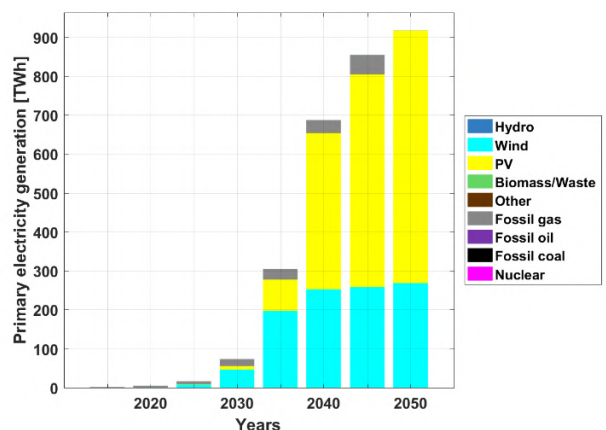
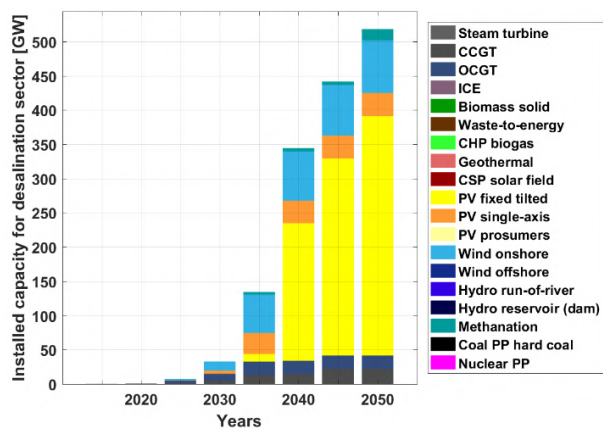

Figure 3.9-22: North America – Technology-wise installed capacities for the desalination sector (left) and primary electricity generation for the desalination sector (right) during the energy transition from 2015 to 2050.

The installed storage capacity for desalination occurs mainly from 2035 onwards, with most of the capacity added in the final five-year period until 2050, as shown in Figure 3.9-23. Gas comprises more than 95% of the 41 TWh installed storage capacity in 2050, whereas batteries contribute the majority of the storage output, which reaches more than 350 TWh_{el} by 2050 as shown in Figure 3.9-23.

Investments in power generation for the desalination sector occur mainly during 2025 onwards, as shown in Figure 3.9.24. A majority of the investments are in wind, PV, and batteries, which reach a high of around 130 b€ in 2040. The levelised cost of water remains stable with a marginal decline through the transition at around just over 1 €/m³ until 2050, as shown in Figure 3.9-24.

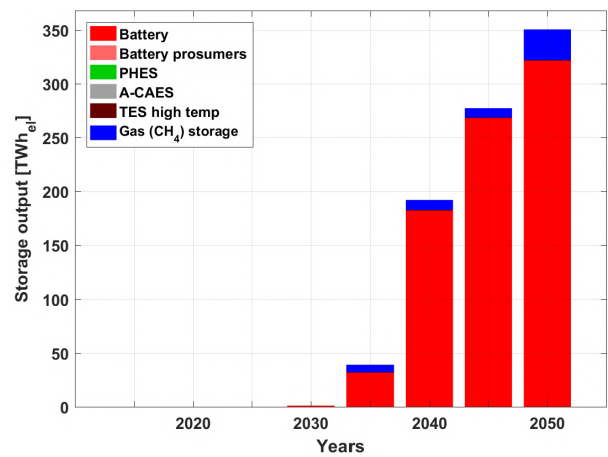
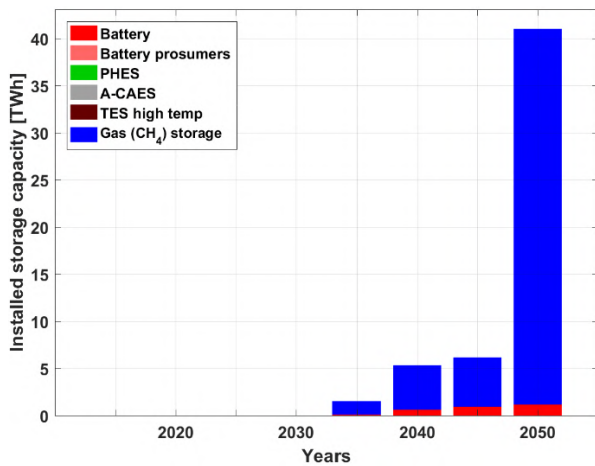

Figure 3.9-23: North America – Installed storage capacity (left) and storage output (right) during the energy transition from 2015 to 2050.

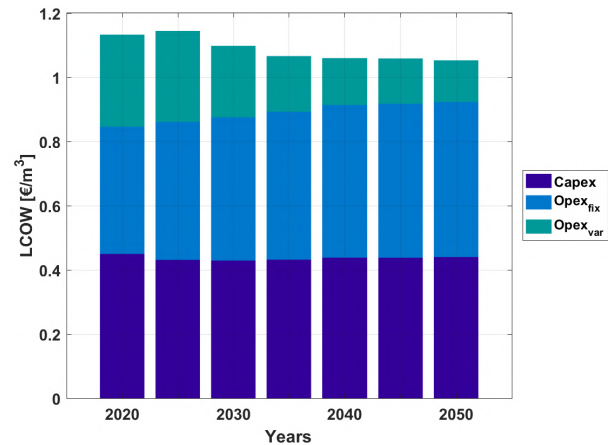
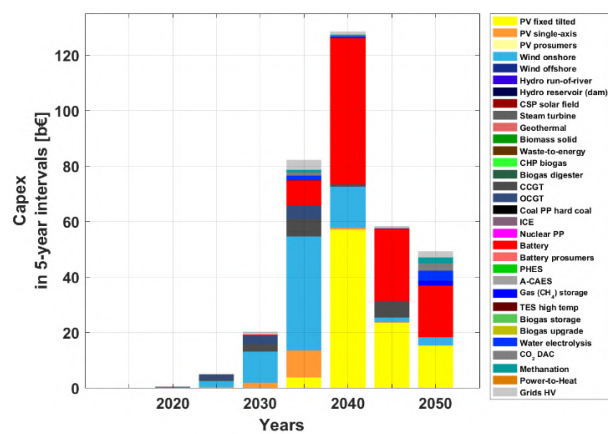

Figure 3.9-24: North America – Capital costs for five-year intervals (left) and levelised cost of water (right) during the energy transition from 2015 to 2050.

Regional outlook

Electricity generation capacities are installed across North America to satisfy the demand for power, heat, transport, and desalination up to 2050. Solar PV capacities are predominantly in the southern regions of North America (USA and Mexico) that have better solar resources through the year, while wind energy capacities are mainly in the northern regions of North America (Central and Mid-West of the USA, as well in Alaska and Canada) that have much better wind conditions, as shown in Figure

3.9-25. Overall, solar PV and wind capacities along with some hydropower capacities constitute the majority of installed capacity in 2050 across North America. Similarly, higher shares of solar PV generation are in the southern regions and higher shares of wind energy are in the northern and central regions as highlighted in Figure 3.9-25. This could enhance the complementarity of solar PV and wind in an interconnected North American energy system.

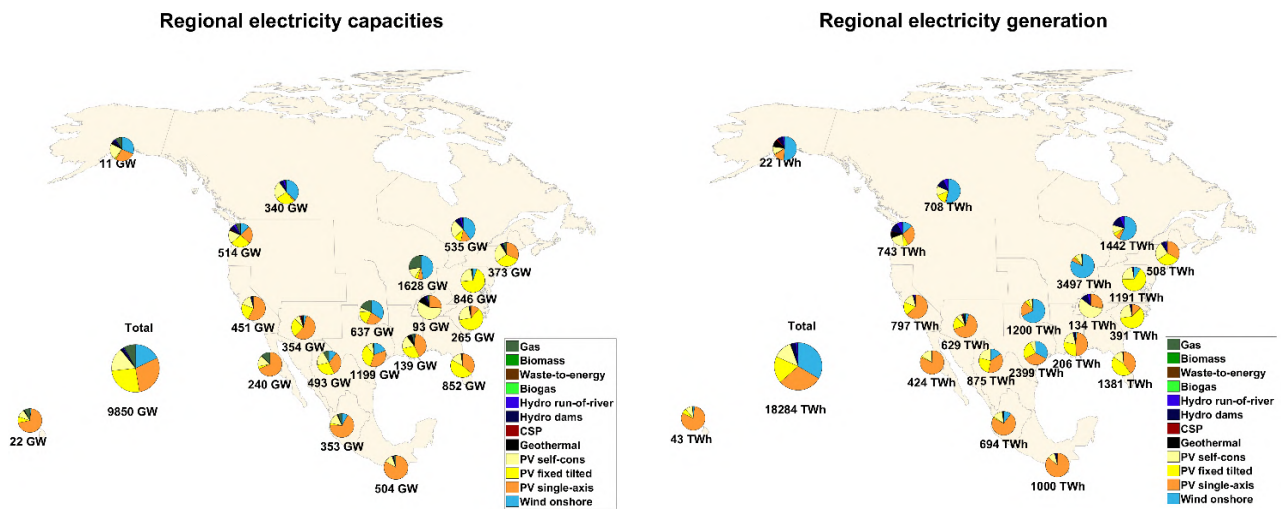

Figure 3.9-25: North America – Regional electricity generation capacities (left) and electricity generation (right) in 2050.

Solar PV capacities are well distributed across the different regions of North America and achieve a total installed capacity base of almost 7020 GW in 2050. Moreover, there are capacities across the southern regions and countries with good solar conditions throughout the year, as shown in Figure

3.9-26. Whereas, wind energy capacities achieve a total installed capacity base of just over 1770 GW in 2050 and are predominantly in the northern and central regions of North America, which have some wind potential. This can be observed in Figure 3.9-26.

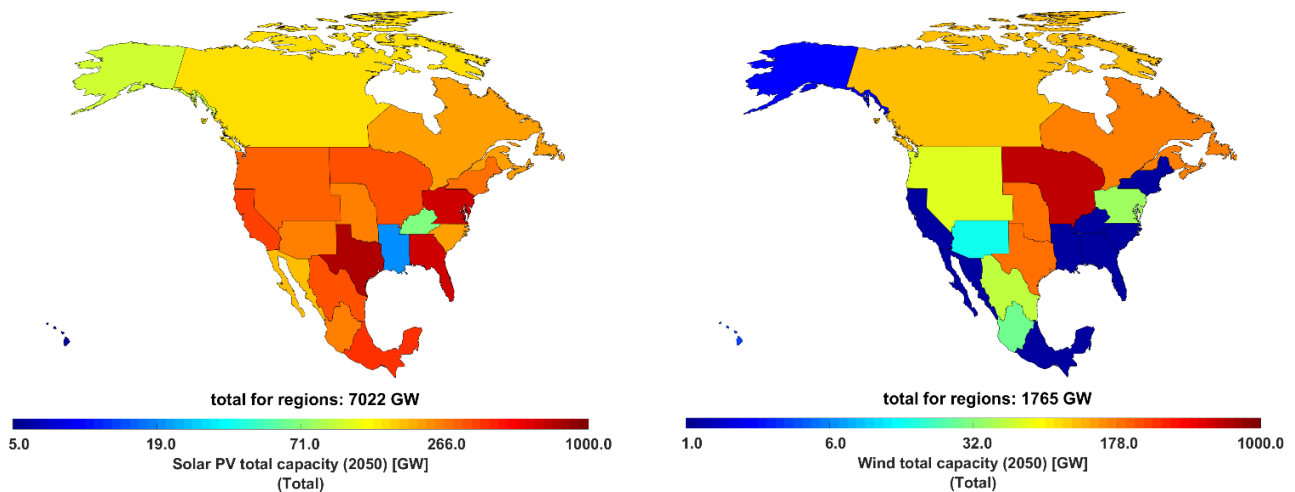

Figure 3.9-26: North America – Regional variation of electricity generation capacities of solar PV (left) and wind energy (right) in 2050.

The electricity generation across the power, heat, transport, and desalination sectors of North America are predominantly from PV and wind in 2050, and the distribution is shown in Figure 3.9-27. Solar PV, which supplies an average of 61.5% of electricity generation across North America, is more common in the southern regions. While wind

energy, which contributes an average of 33.3% of electricity generation across North America is mainly, found in the northern and central regions. Overall, solar PV and wind generate most of the electricity needed across North America by 2050, which is around 94.2% of total electricity generation.

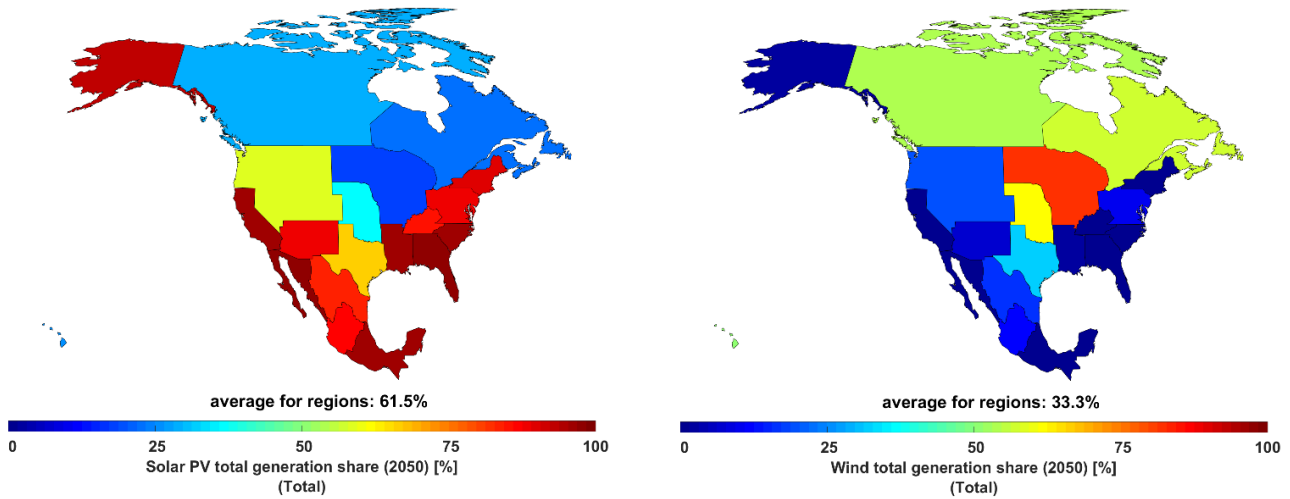

Figure 3.9-27: North America – Regional variation of electricity generation shares of solar PV (left) and wind energy (right) in 2050.

Utility-scale and prosumer batteries contribute a major share of electricity storage capacities, with some shares of A-CAES by 2050, as shown in Figure 3.9-28. Storage capacities are much higher in the southern parts of North America (USA and Mexico), to complement higher shares of installed solar PV capacities, compared to the northern

regions. Batteries, both prosumers and utility-scale, deliver the largest shares of output by 2050, as shown in Figure 3.9-28. Additionally, A-CAES contributes complementary shares of electricity storage output through the transition, across the different regions of North America.

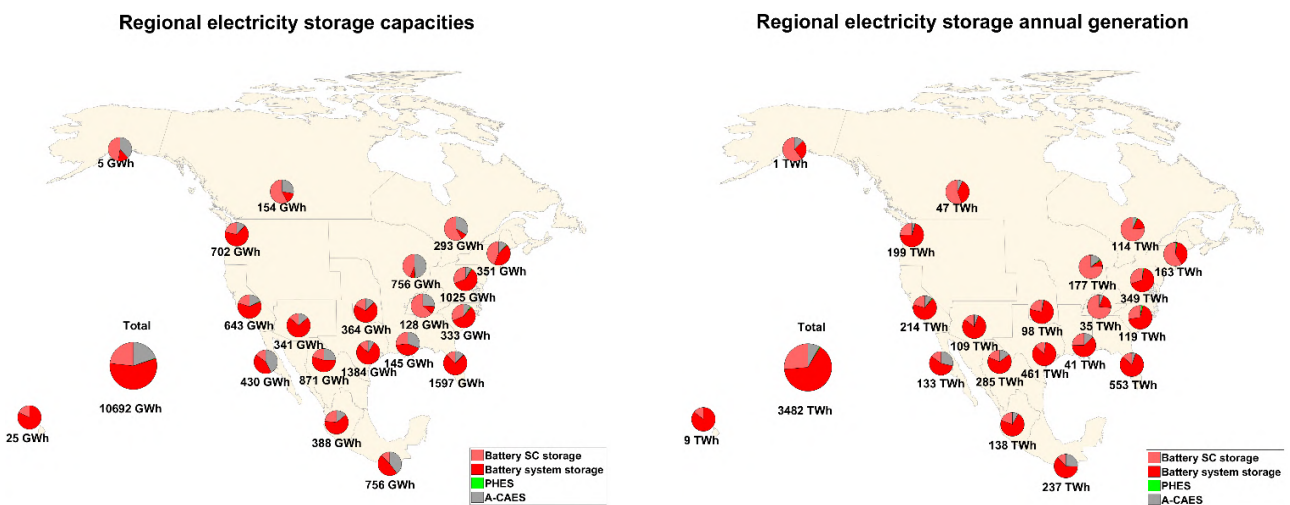

Figure 3.9-28: North America – Regional electricity storage capacities (left) and electricity storage annual throughput (right) in 2050.

The storage output across the power, heat, transport, and desalination sectors of North America is predominantly from batteries (both utility-scale and prosumers) and some synthetic natural gas supply in 2050, as shown in Figure 3.9-29. Batteries, which supply an average of 18.5% of the storage output across North America, are more

common in the southern regions. Synthetic natural gas, which supplies an average of 0.2% of the total electricity demand across North America, is distributed across all regions of North America. This is complemented with a supply share of storage from biomethane of around 0.1% in 2050 across North America.

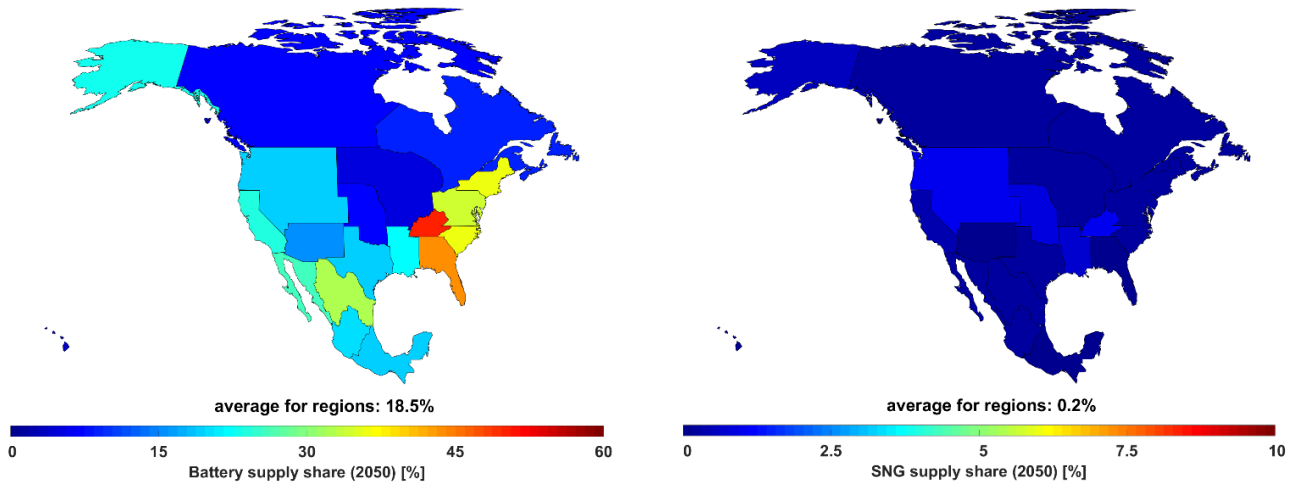

Figure 3.9-29: North America – Regional variation of storage supply shares of batteries (left) and synthetic natural gas (right) in 2050.

Greenhouse Gas Emissions

The results of the energy transition towards a 100% renewable energy system indicate a sharp decline in GHG emissions until 2050, reaching zero GHG emissions by 2050 across the power, heat, transport, and desalination sectors in North America as shown in Figure 3.9-30. The power

sector undergoes a deep decarbonisation by 2030, whereas for the heat and transport sectors this occurs mostly between 2030 and 2050. Moreover, the remaining cumulative GHG emissions comprise around 68 GtCO_{2eq} from 2018 to 2050. Therefore, the energy transition pathway for North America is in adherence to the ambitious Paris Agreement target of 1.5°C.

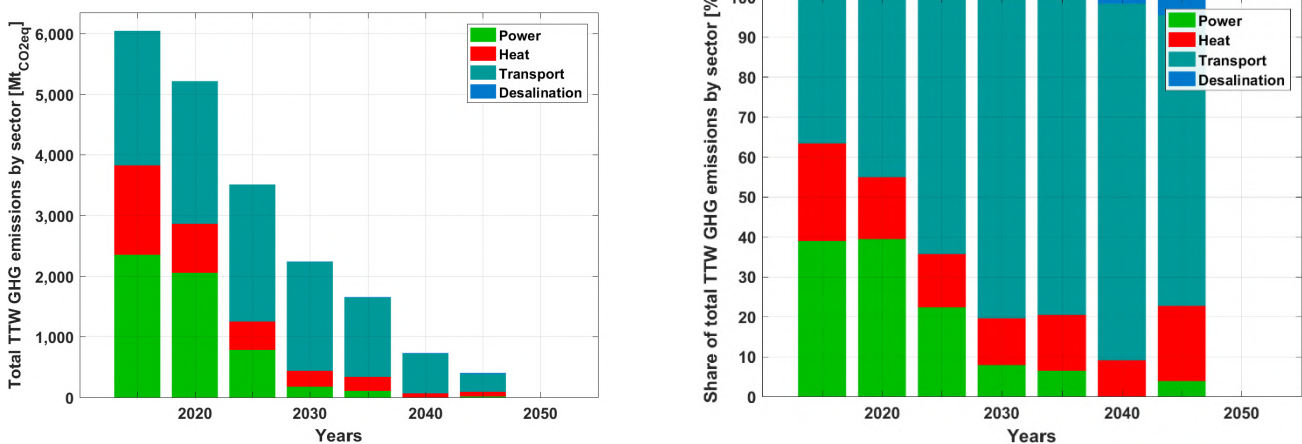

Figure 3.9-30: North America – Sector-wise GHG emissions (left) and the share of GHG emissions of different sectors (right) during the energy transition from 2015 to 2050. Tank to Wheel (TTW) considers GHG emissions from readily available fuels and does not consider GHG emissions from the upstream production and delivery of fuels.

GHG emissions from the power sector decline through the transition from around 2,400 MtCO₂ eq./a in 2015 to zero by 2050 as shown in Figure 3.9-31. Similarly, GHG emissions from the heat sector decline through the transition from around 1,450 MtCO₂ eq./a in 2015 to zero by 2050 as shown in Figure 3.9-31.

GHG emissions from the transport sector decline through the transition from around 2,300 MtCO₂

eq./a in 2020 to zero by 2050, as shown in Figure 3.9-32. Whereas, GHG emissions from the desalination sector, which are much lower than those of other sectors, increase through the transition from around 1.8 MtCO₂ eq./a in 2015 to over 18 MtCO₂ eq./a in 2045 and thereafter drop to zero by 2050, also visible in Figure 3.9-32.

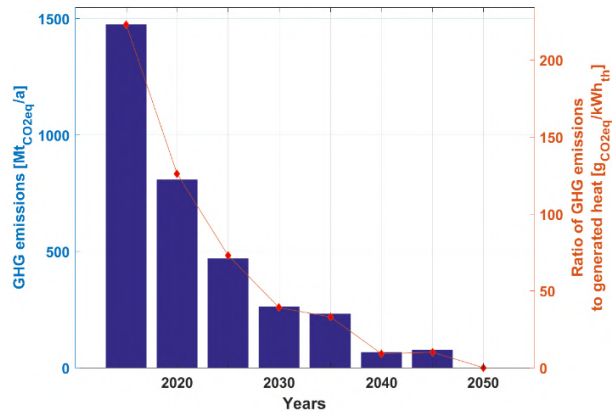
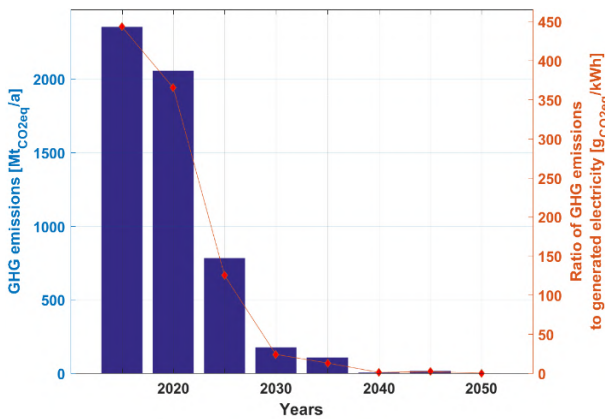

Figure 3.9-31: North America – GHG emissions in the power sector (left) and GHG emissions in the heat sector (right) during the energy transition from 2015 to 2050.

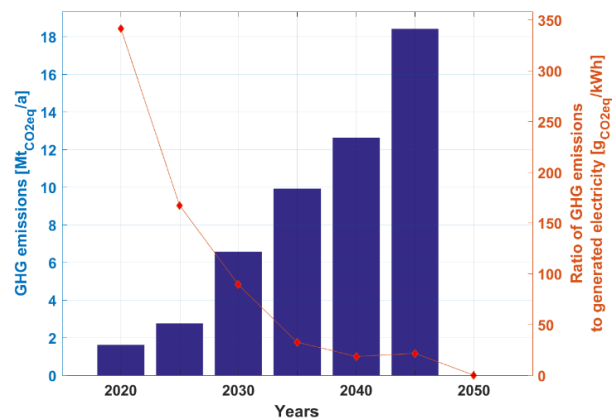
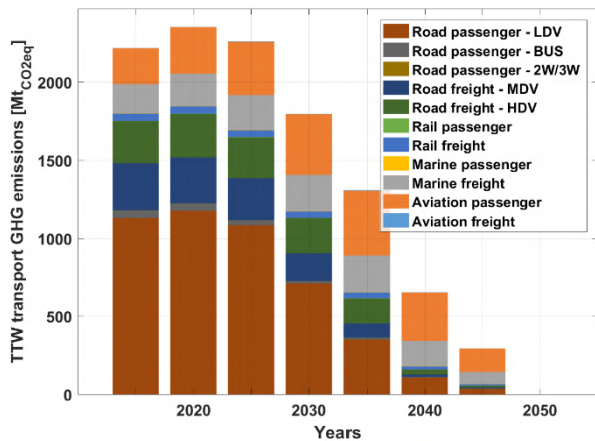

Figure 3.9-32: North America – GHG emissions in the transport sector (left) and GHG emissions in the desalination sector (right) during the energy transition from 2015 to 2050. Tank to Wheel (TTW) considers GHG emissions from readily available fuels and does not consider GHG emissions from the upstream production and delivery of fuels.

Jobs in the Power Sector across North America

Solar PV (1.62 million jobs in 2025) along with wind energy (762 thousand jobs in 2025) emerge to be the dominant job creating sectors during the transition period as shown in Figure 3.9-33. Additionally, hydropower (180 thousand jobs by 2050) and bioenergy (180 thousand jobs by 2050) create a stable share of jobs through the transition period. Storage led by batteries begin to create

jobs from 2025 onwards with a stable share until 2050, with 330 thousand jobs in the battery sector. Whereas, coal and gas power generation associated jobs are seen to decline rapidly. Overall, jobs are set to increase from around 1.8 million in 2015 to nearly 3.8 million, with the rapid ramp up in installations up to 2025 and then a steady decline towards nearly 2.7 million by 2050.

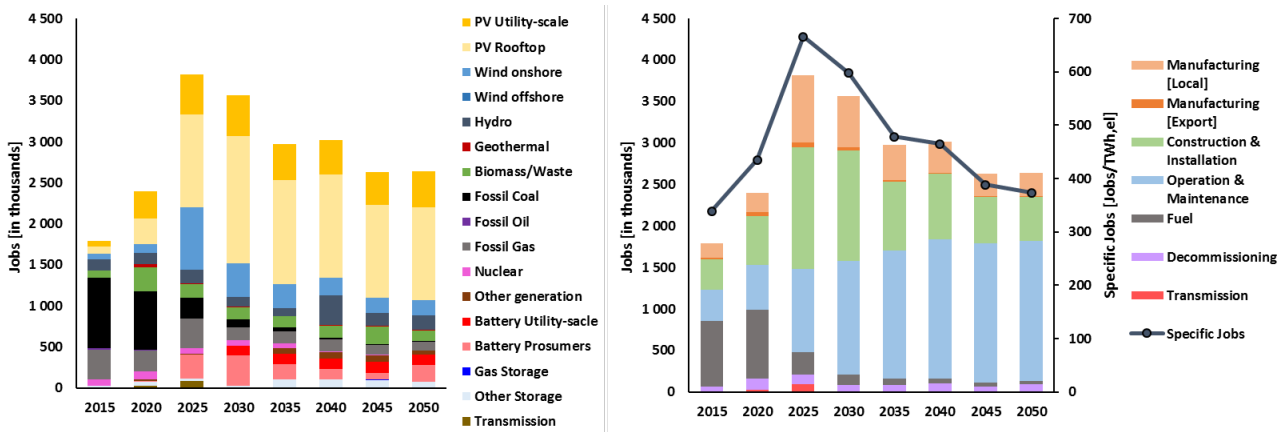

Figure 3.9-33: North America – Jobs created by various power generation and storage technologies (left) and jobs created based on different categories with the development of electricity demand specific jobs (right) during the energy transition from 2015 to 2050.

Manufacturing, construction and installation of renewable energy technologies create a significant share of jobs enabling the rapid ramp up of capacity until 2030, beyond this period there is a stable number of jobs created in these sectors up to 2050. Furthermore, manufacturing includes both for local use as well as for exports to the other regions. The share of manufacturing jobs along with a marginal share of exports initially rises up to 2025 (21% and 1% of total jobs respectively), beyond which they decline. As manufacturing is predominantly to cater to the local power markets across North America with domestic manufacturing having a share of 11% of total jobs by 2050 and only 4 thousand jobs for exports. On the contrary, fuel jobs continue to decline through the transition

period reaching just 2% of total jobs by 2050, as capacities of conventional power plants continue to decline. Operation and maintenance jobs continue to grow through the transition period and become the major job creating segment by 2050 with 64% of total jobs. As operation and maintenance jobs last through the lifetime of power plants, they offer relatively stable long-term job prospects. This has the potential to create a positive effect in many parts of the USA that suffer from persistent unemployment⁷⁸. The electricity demand specific jobs initially increase from 339 jobs/TWh_{el} in 2015 to 666 jobs/TWh_{el} in 2025 with the rapid ramp up in renewable energy installations. Beyond 2025, it declines steadily to 374 jobs/TWh_{el} by 2050 as highlighted in Figure 3.9-33.

3.10. South America

The South American region including Central American countries is comprised of growing economies, with around a 6% share of global GDP⁶³. Population in South America is 464 million in 2015 representing a share of 6% in world population, which is estimated to be also 6% in 2050. With steady economic growth in most of the countries, the need for energy is increasing. The energy sector in South America is a key ingredient to its overall development. Many of the countries have a well-developed hydropower sector, such as Brazil with more than 70% of its electricity generated through hydro⁶⁶, and Paraguay runs its entire power sector based on hydropower and further exports excess generation to neighbouring countries. Overall, the region has amongst the least carbon intensive power sectors globally. However, with growing needs and a need to ensure security

of supply, effective utilisation of all available renewable energy resources and maximum synergy between various regions of the South American countries will foster sustainable development in the region. The detailed results for the energy transition across South America are available in a supplementary data file, the link for the file can be found in the Appendix.

Penetration of renewables is not just a matter of replacing hydrocarbons with zero-carbon sources of energy supply – it also represents a significant change in resource efficiency. This is illustrated by the overall electrification across the power, heat, transport, and desalination sectors as shown in Figure 3.10-1.

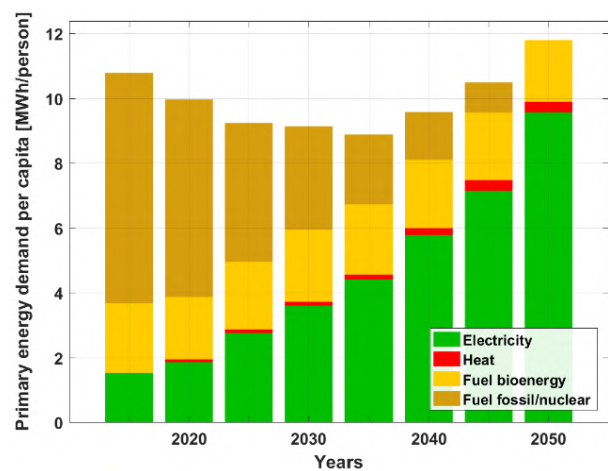
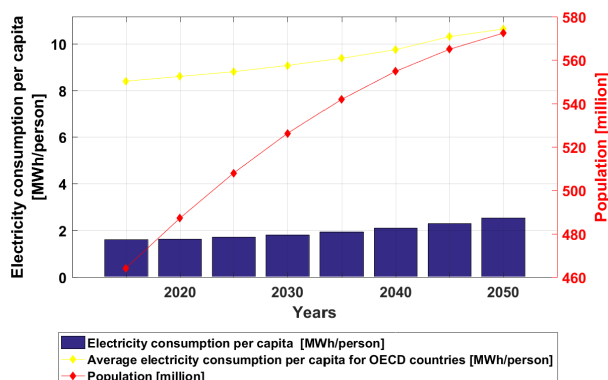
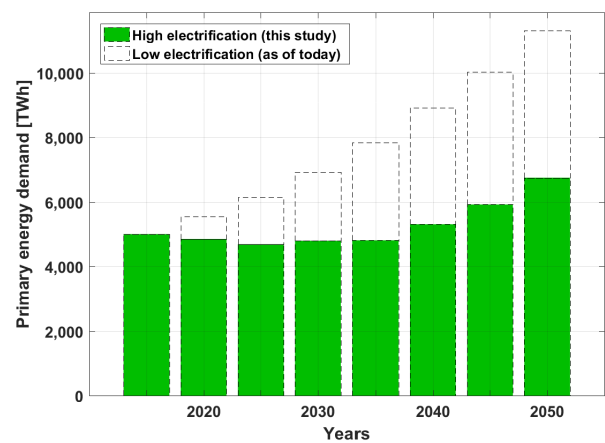
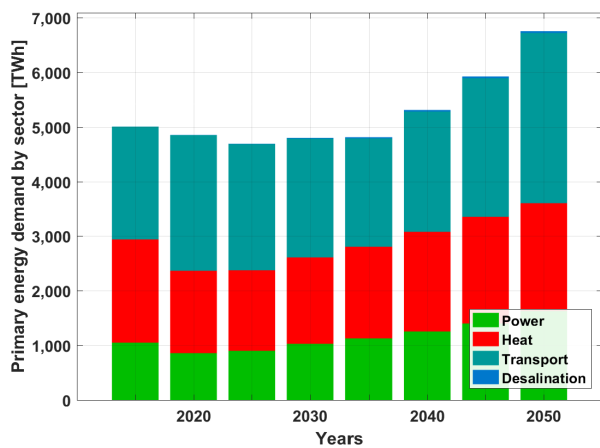

Figure 3.10-1: South America – Primary energy demand sector-wise (top left), efficiency gain in primary energy demand (top right), electricity consumption per capita with population (bottom left) and primary energy demand per capita (bottom right) during the energy transition from 2015 to 2050.

The primary energy demand assuming high electrification, which is the basis for this study, decreases marginally from 5,000 TWh in 2015 to around 4,800 TWh by 2035 and increases up to 6,700 TWh by 2050 as shown in Figure 3.10-1. On the contrary, with low shares of electrification resulting from the adoption of current practices until 2050, the primary energy demand would reach nearly 11,500 TWh by 2050. This massive gain in energy efficiency is primarily due to a high level of electrification of more than 80% resulting in reduction of around 4,800 TWh by 2050, in comparison to the continuation of current practices with low shares of electrification. The population across South America is expected to grow from 464 to 572 million by 2050. Correspondingly, the average per capita energy demand decreases from around 10.5 MWh/person in 2015 to around 9 MWh/person by 2035 and increases up to nearly 12 MWh/person by 2050. Additionally, a substantial demand from fuel conversion technologies arises

beyond 2040, in producing renewable-based fuels for the transport sector across South America.

Energy Supply

The electricity generation capacity across South America satisfies demand from all energy sectors including power, heat, transport and desalination. The total installed capacity grows massively from about 300 GW in 2015 to around 2700 GW by 2050 as shown in Figure 3.10-2. In the initial period of the transition, some shares of wind and hydropower capacities are installed up to 2030, but in the later part of the transition solar PV dominates the shares of installed capacities reaching almost 2250 GW by 2050. On the other hand, the shares of fossil fuels and nuclear decline through the transition to zero by 2050. Some shares of gas remain, but the fuel switches from fossil-based gas to synthetic natural gas produced with renewable electricity and biomethane.

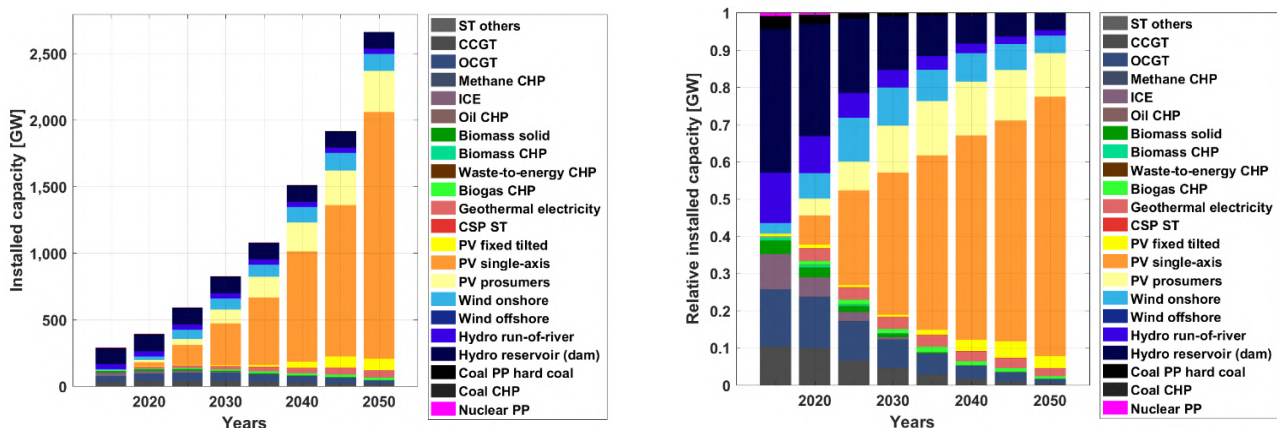

Figure 3.10-2: South America – Technology-wise installed capacities (left) and technology-wise shares of installed capacities (right) during the energy transition from 2015 to 2050.

Electricity generation from the various technologies to cover the demand of power, heat, transport, and desalination sectors is shown in Figure 3.10-3. Hydropower was a main contributor to the total electricity generation in 2015. However, the amount of electricity generation from hydropower remains almost constant over the transition due to sustainability reasons. Solar PV supply increases through the transition from 29% in 2030 to about 62% by 2050, becoming the lowest cost energy source. The share of wind energy increases to 23% of total electricity generation by 2030 and thereafter declines to around 10% by 2050. In the

heat sector, heat pumps play a significant role through the transition with a share of nearly 34% of heat generation by 2050 on both the district and individual levels, as indicated in Figure 3.10-3. On the other hand, gas-based heating decreases through the transition from over 32% in 2015, to around 9% by 2050. Additionally, biomass-based DH and IH, electric heating and some shares of solar thermal eliminate fossil fuels based heating by 2050. Fossil gas is eliminated and replaced by synthetic gas produced from renewable energy through the transition.

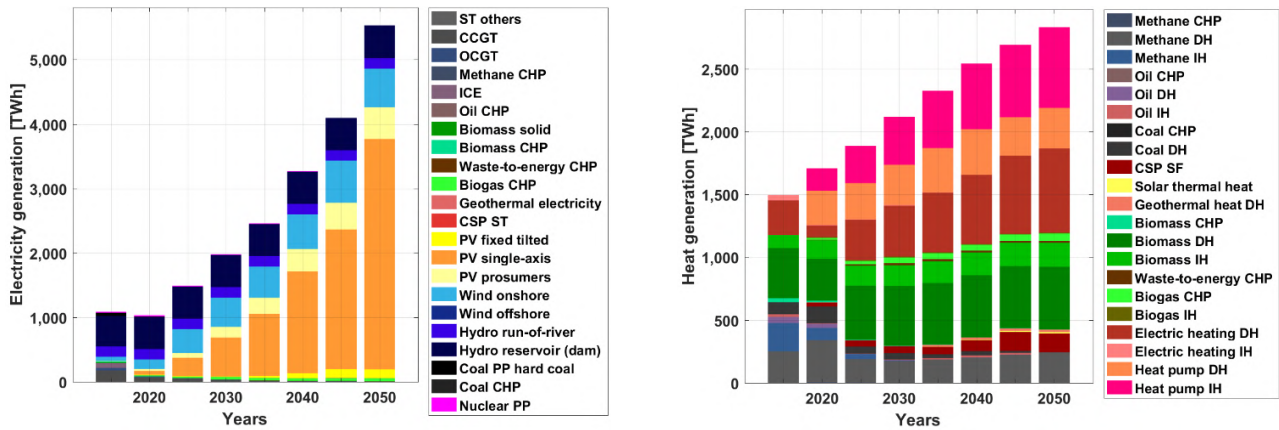

Figure 3.10-3: South America – Technology-wise electricity generation (left) and technology-wise heat generation (right) during the energy transition from 2015 to 2050.

Energy Storage

Energy storage technologies play a critical role in enabling a secure energy supply throughout South America, fully based on renewable energy across different sectors. As highlighted in Figure 3.10-4, storage output covers around 850 TWh_{el} of total electricity demand in 2050. The ratio of electricity demand covered by energy storage to electricity generation increases significantly to over 16.5% by

2035 and thereafter declines marginally to just under 16% by 2050. Additionally, around 3% is covered by heat storage conversion to electricity by 2050. Batteries emerge as the most relevant electricity storage technology contributing about 94% of the total electricity storage output by 2050. Additionally, a significant share of gas storage is installed to provide seasonal storage primarily during the winter and monsoon seasons across South America.

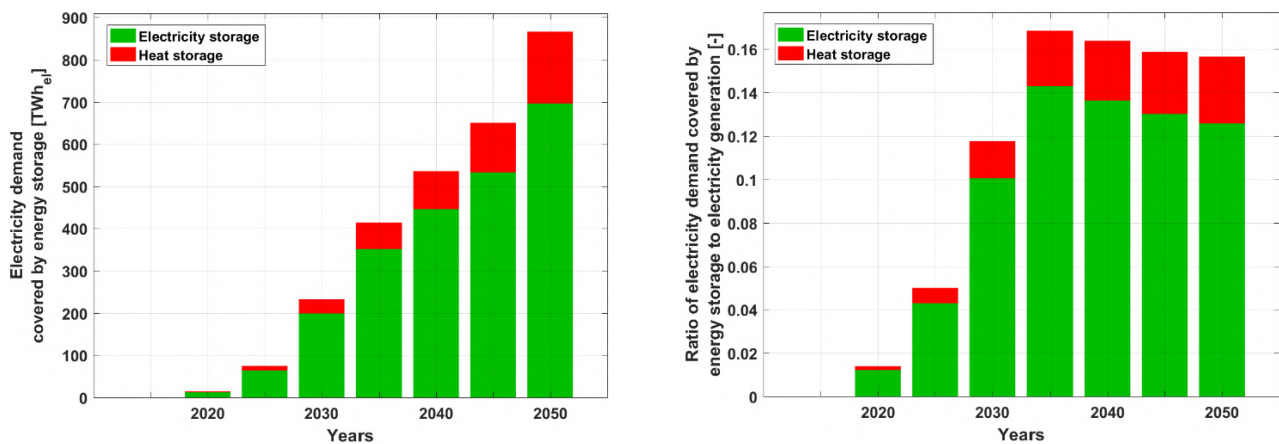

Figure 3.10-4: South America – Electricity demand covered by energy storage (left) and ratio of electricity demand covered by different forms of energy storage (right) during the energy transition from 2015 to 2050.

Similarly, heat storage plays a vital role in ensuring heat demand is covered across all the sectors. As indicated in Figure 3.10-5, storage output covers more than 550 TWh_{th} of the total heat demand in 2050 and heat storage technologies are crucial to meet this demand. The ratio of heat demand covered by energy storage to heat generation increases substantially to over 16% by 2050, also shown in Figure 3.10-5. Thermal energy storage

(TES) emerges as the most relevant heat storage technology with around 67% of heat storage output by 2050. Furthermore, power-to-gas (PtG) contributes around 33% of heat storage output in 2050. As fossil fuel usage for heat generation is completely eliminated in the final five year period from 2045-2050, there is an increase in heat storage utilisation.

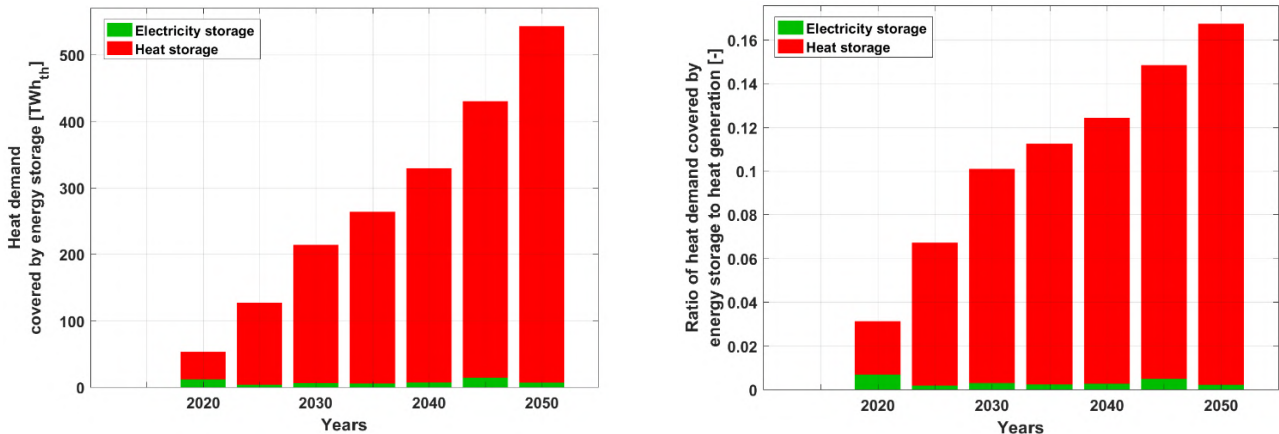

Figure 3.10-5: South America – Heat demand covered by energy storage (left) and the ratio of heat demand covered by different forms of energy storage (right) during the energy transition from 2015 to 2050.

Costs and Investments

The total annual costs are in the range of 260-310 b€ through the transition period and are well distributed across the major sectors of power, heat, and transport, as desalination demand in South America is relatively lower compared to other regions of the world. In addition, as indicated in Figure 3.10-6, CAPEX increases through the

transition, as the share of fuel costs continues to decline. The steady increase in CAPEX-related energy system costs indicate that fuel imports and the respective negative impacts on trade balances will fade out through the transition. In addition, a low fuel import dependency will lead to higher levels of energy security across South America.

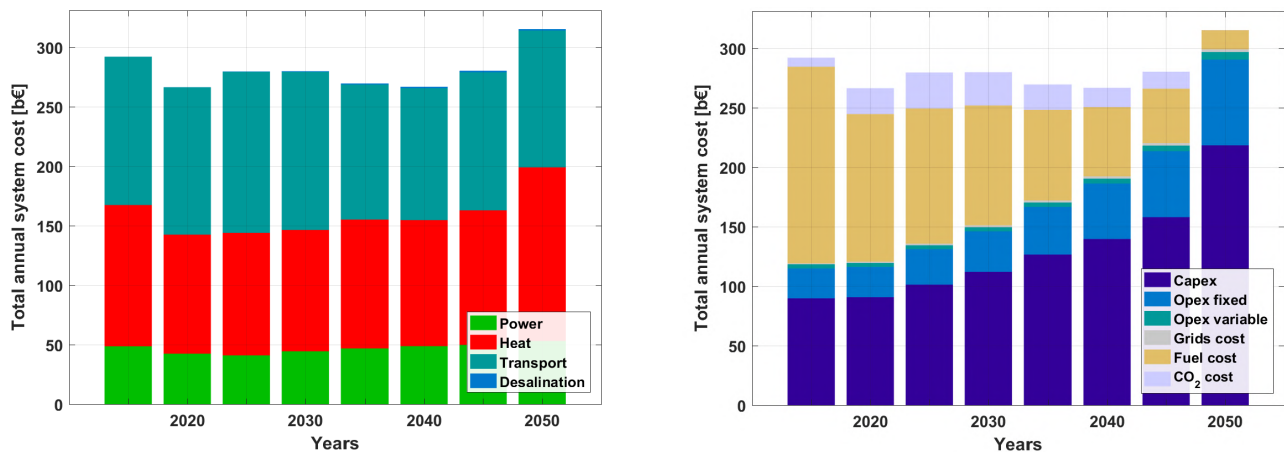

Figure 3.10-6: South America – Annual system costs, sector-wise (left) and functionality-wise (right) during the energy transition from 2015 to 2050.

As increasing shares of power generation capacities are added across South America, renewable energy sources become the least costing power generation sources⁶⁶. As indicated in Figure 3.10-7, levelised cost of energy declines marginally from over 60 €/MWh in 2025 to around 54 €/MWh by 2050. Moreover, the levelised cost of energy is increasingly dominated by capital costs as fuel costs continue to decline through the transition

period, which could mean increased self-reliance in terms of energy for South America by 2050, as mentioned earlier. Capital costs are well spread across a range of technologies with major investments for PV, wind energy, batteries, heat pumps, and synthetic fuel conversion up to 2050, as shown in Figure 3.10-7. The cumulative investments are about 2,560 b€ through the transition from 2016-2050.

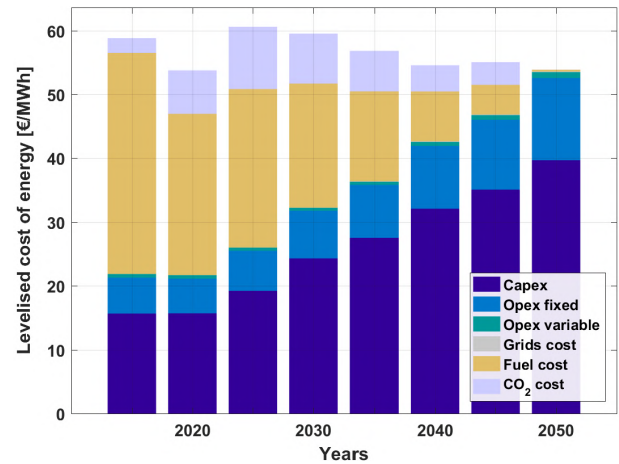
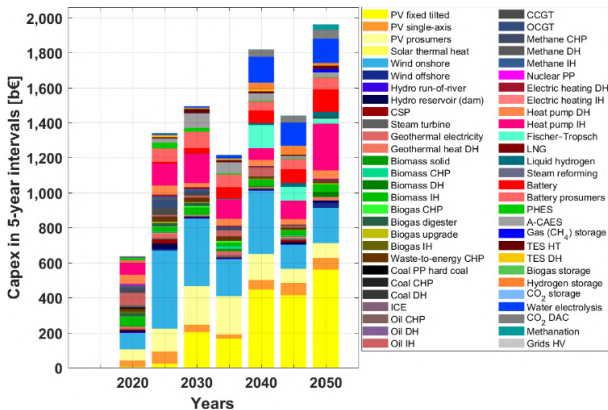

Figure 3.10-7: South America – Capital costs for five-year intervals (left) and levelised cost of energy (right) during the energy transition from 2015 to 2050.

Outlook across Sectors

Different trends in the power, heat, transport, and desalination sectors across South America emerge through the transition. As the sectors transition towards having higher shares of renewable energy, different technologies have vital roles in ensuring the stability of the energy system. A closer look at the individual sectors provides further insights into the energy transition across South America towards 100% renewable energy.

Power and Heat

The total installed power generation capacity increases from over 300 GW in 2015 to nearly

1,200 GW by 2050, as shown in Figure 3.10-8. Across the power sector, solar PV with over 850 GW, hydropower with around 200 GW and wind with 30 GW constitute the majority of installed capacities by 2050. In the heat sector, heat pumps, electric heating, oil IH and biomass-based heating constitute the majority of installed capacities by 2050, also shown in Figure 3.10-8. A significant increase in installed capacities of heat pumps and biomass-based heating occurs in the final five-year period leading up to 2050, as fossil fuels are completely eliminated from the energy system.

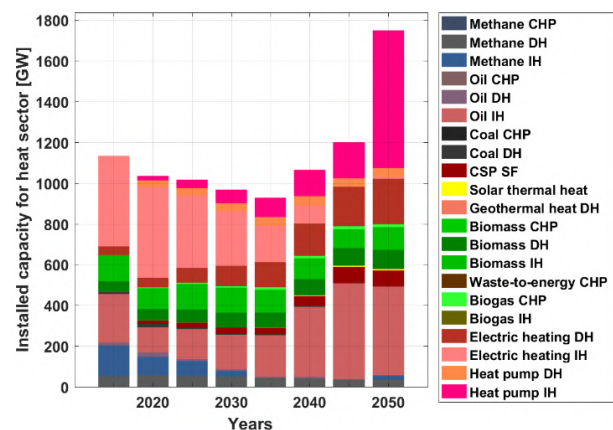
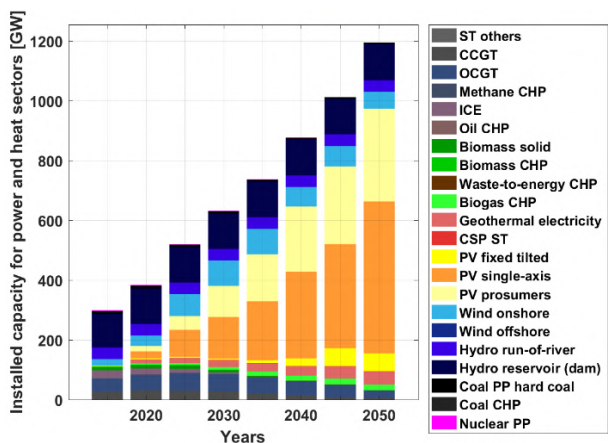

Figure 3.10-8: South America – Technology-wise installed capacities for power (left) and heat (right) during the energy transition from 2015 to 2050.

The transition across South America results in a power and heat sector dominated by fossil fuel and nuclear in 2015 moving towards a solar PV and hydropower dominated sector by 2050, with some wind energy and bioenergy as shown in Figure 3.10-9. The primary electricity generation increases from over 1,000 TWh in 2015 to just over 2,500

TWh by 2050, which is primarily from PV, hydro and wind. Heat generation increases steadily from around 1,500 TWh in 2015 to around 2,750 TWh by 2050, which is predominantly from heat pumps, electric heating and biomass-based heating, also shown in Figure 3.10-9.

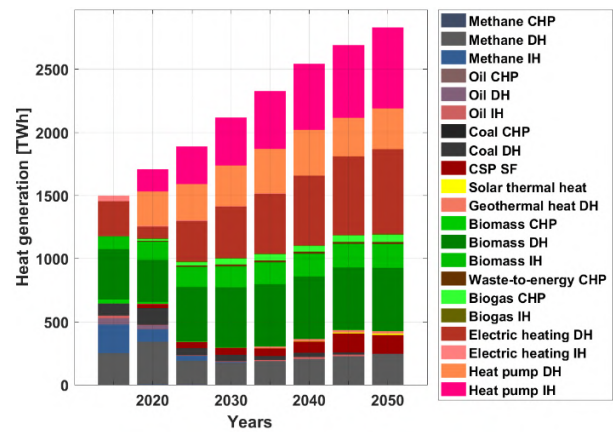
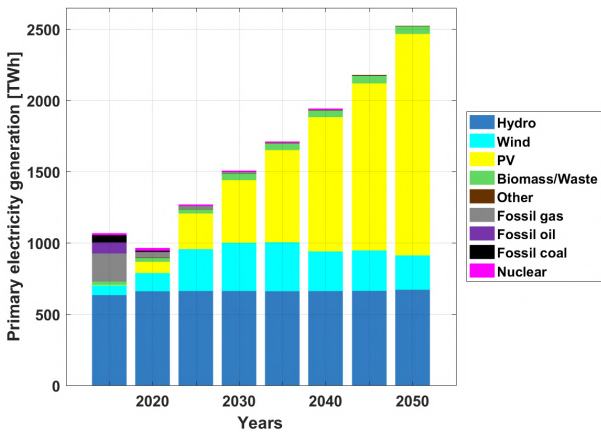

Figure 3.10-9: South America – Primary electricity generation (left) and technology-wise heat generation (right) during the energy transition from 2015 to 2050.

The installed electricity storage capacity increases from just about 0.1 TWh in 2025 to around 1.3 TWh by 2050, as shown in Figure 3.10-10. Utility-scale and prosumer batteries with some shares of A-CAES are installed through the transition. The installed capacities of A-CAES are also a consequence of the modelling approach, which prioritises full domestic energy supply for all South

American regions. The installed heat storage capacity increases gradually until 2045 to around 3.3 TWh, but in the final five-year period up to 2050, an increase in capacity of gas storage of up to 5.5 TWh is observed, as shown in Figure 3.10-10. This jump in capacity addition is mainly to provide seasonal storage across South America covering the heat demand in the absence of fossil fuels.

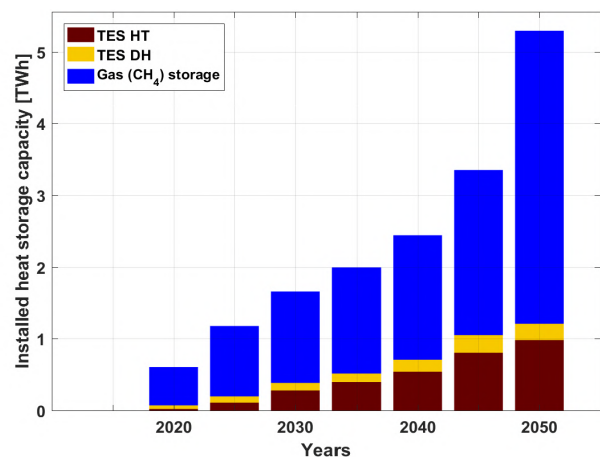
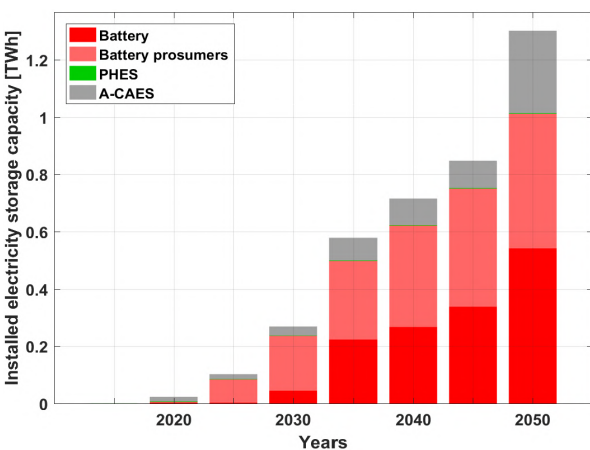

Figure 3.10-10: South America – Installed electricity storage capacities (left) and heat storage capacities (right) during the energy transition from 2015 to 2050.

Utility-scale and prosumer batteries contribute a major share of electricity storage output with nearly 400 TWh_{el} by 2050, as highlighted by Figure 3.10-11. In addition, some shares of A-CAES contribute through the transition. TES emerges as the most relevant heat storage technology with around 67%

of heat storage output by 2050, also seen in Figure 3.10-11. Gas storage contributes around 33% of the heat storage output in 2050 covering predominantly seasonal demand, previously covered by fossil gas.

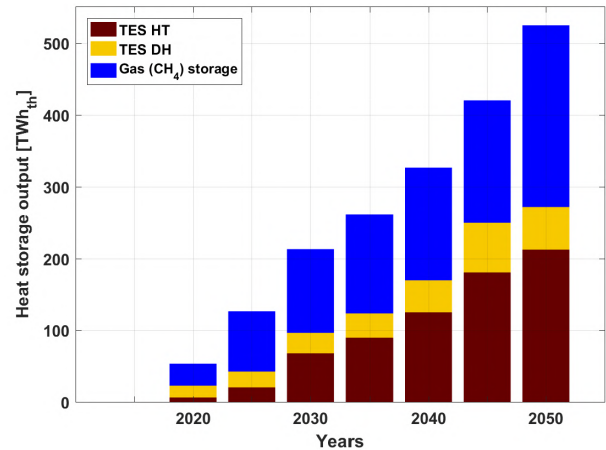
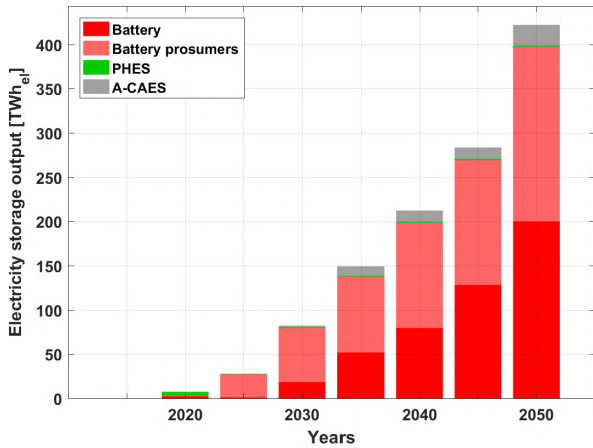

Figure 3.10-11: South America – Electricity storage output (left) and heat storage output (right) during the energy transition from 2015 to 2050.

LCOE of the power sector decreases substantially from around 75 €/MWh in 2015 to around 38 €/MWh by 2050, as shown in Figure 3.10-12. LCOE is predominantly comprised of CAPEX as fuel costs decline through the transition. Similarly, LCOH of the heat sector decreases from around 70 €/MWh in 2015 to around 43 €/MWh by 2045 and further

on increases to around 51 €/MWh by 2050, as shown in Figure 3.10-12. LCOH is predominantly comprised of CAPEX as fuel costs decline through the transition. Despite a substantial increase in heat demand across South America, mainly driven by industrial process heat, the LCOH declines through the transition.

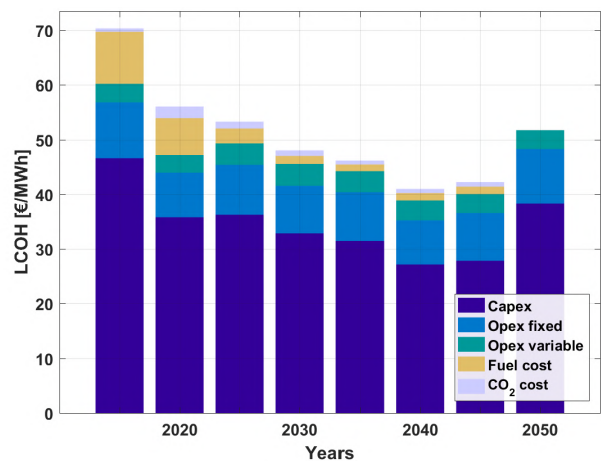
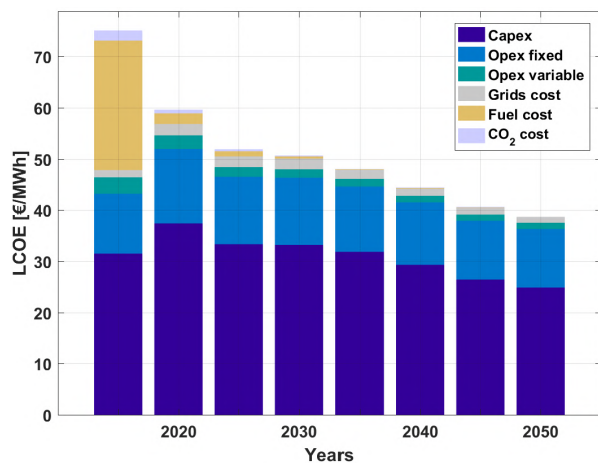

Figure 3.10-12: South America – Levelised cost of electricity (left) and levelised cost of heat (right) during the energy transition from 2015 to 2050.

Investments are well spread across a range of power generation technologies with the majority shares in solar PV up to 2050, with some shares in wind energy and hydropower as shown in Figure 3.10-13. Investments in the heat sector are mainly in heat pumps, with some shares in biomass

heating and electric heating up to 2050, also shown in Figure 3.10-13. The steep increase in heat pump investments in the final five-year period until 2050 is mainly to cover the heat demand in the absence of fossil fuels as well as the lower costs of heat pumps by 2050.

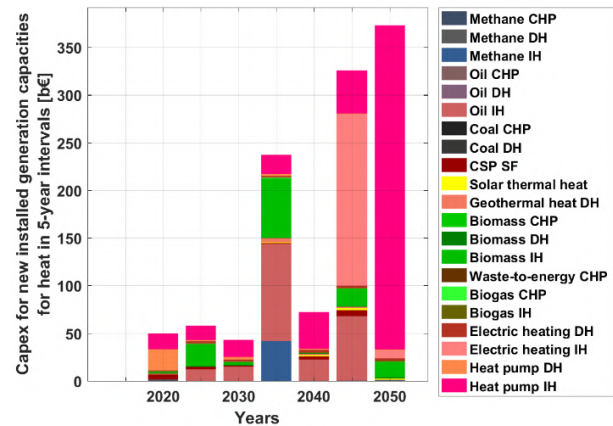
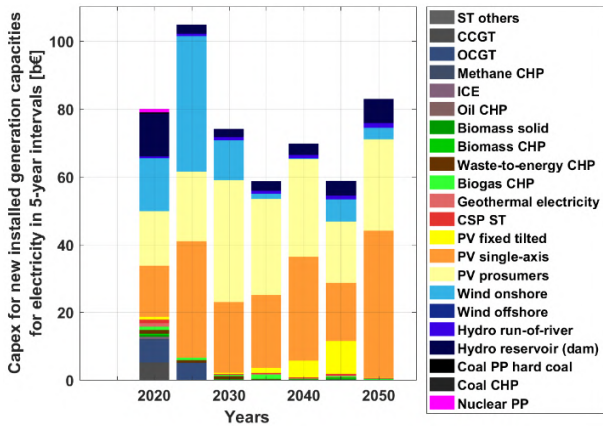

Figure 3.10-13: South America – Capital costs of installed generation capacities in five-year intervals for electricity (left) and heat (right) during the energy transition from 2015 to 2050.

Transport

The primary energy demand of the transport sector across South America is almost twice the energy demand from the power sector at over 2,000 TWh in 2015. However, this demand after an initial increase, thereafter a decline and then again an increase remains just over 2,000 TWh by 2050, mainly due to the efficiency gains brought about by electrification of the sector as shown in Figure 3.10-14. On the contrary, fossil fuels consumption in the transport sector across South America is seen to decline through the transition from about 88% in

2015 to zero by 2050. While, liquid fuels produced by renewable electricity contribute around 30% of final energy demand in 2050. In addition, hydrogen constitutes more than 26% of final energy demand in 2050. Sustainably produced biofuels contribute a minor share to enable a complete elimination of fossil fuel usage in the transport sector. Electrification of the transport sector creates an electricity demand of around 2,800 TWh_{el} by 2050. The massive demand for liquid fuels kicks in from 2040 onwards up until 2050, as indicated in Figure 3.10-14.

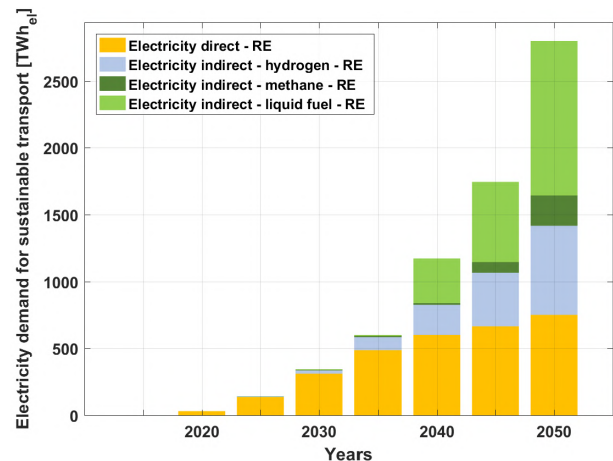
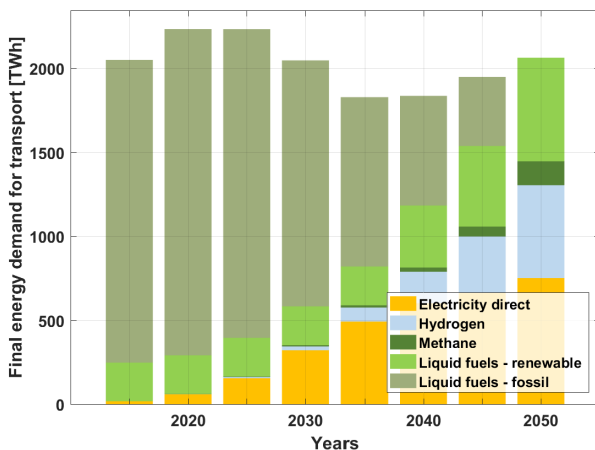

Figure 3.10-14: South America – Final energy demand for transport (left) and electricity demand for sustainable transport (right) during the energy transition from 2015 to 2050.

Installed power generation capacities for the transport sector increase substantially through the transition to around 1,450 GW by 2050, as shown in Figure 3.10-15. Solar PV and wind form the majority share of the power generation capacities for the transport sector, as they are the lowest cost

energy sources by 2050. Similarly, electricity generation increases substantially up to almost 3,000 TWh by 2050 also to be seen in Figure 3.10-15. Solar PV and wind energy generate all the electricity required to meet the demand of the transport sector in 2050.

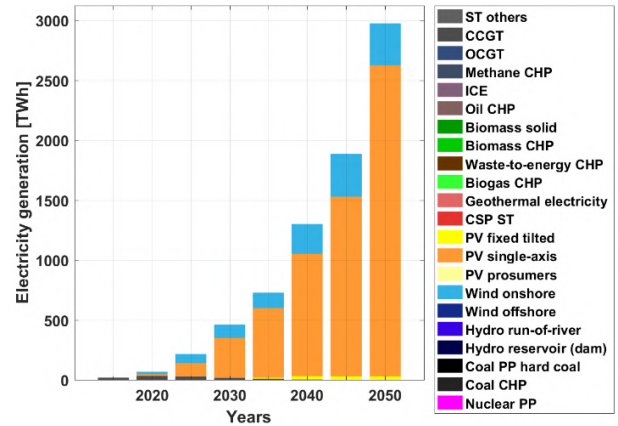
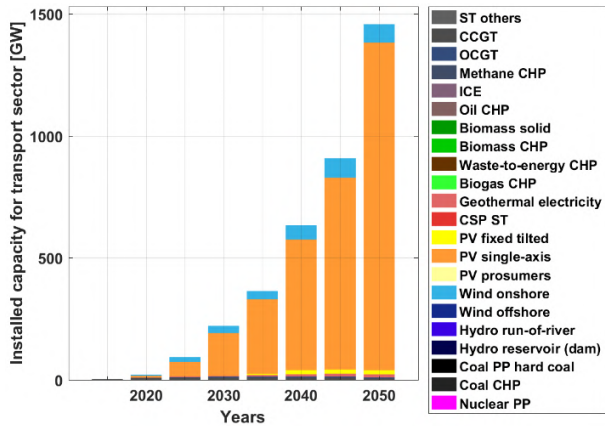

Figure 3.10-15: South America – Transport sector installed power generation capacity (left) and electricity generation (right) during the energy transition from 2015 to 2050.

A critical aspect to complement the electrification of the transport sector is the installation of storage technologies. As seen in Figure 3.10-16, the installed capacities of electricity storage increase through the transition to over 1.3 TWh by 2050. The majority of installed capacities are utility-scale batteries and A-CAES. Similarly, electricity storage output increases through the transition to over 430 TWh_{el} by 2050 as shown in Figure 3.10-16. Utility-

scale batteries play a vital role as they contribute a major portion of the output through the transition, with over 300 TWh_{el} by 2050. The relatively low electricity storage of less than 15% of generated electricity for the transport sector is enabled by the flexible operation of batteries, water electrolyser units, and hydrogen buffer storage for synthetic fuel production.

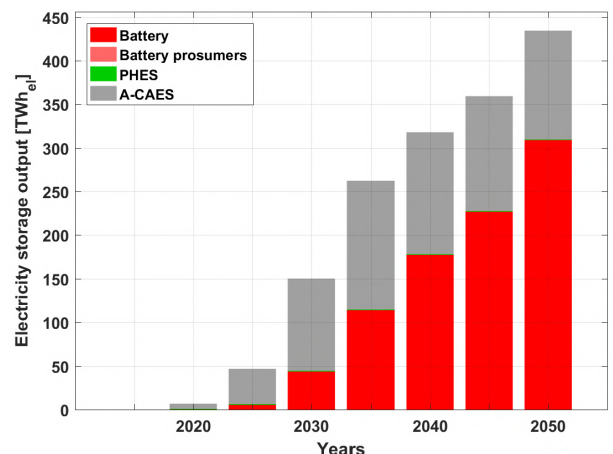
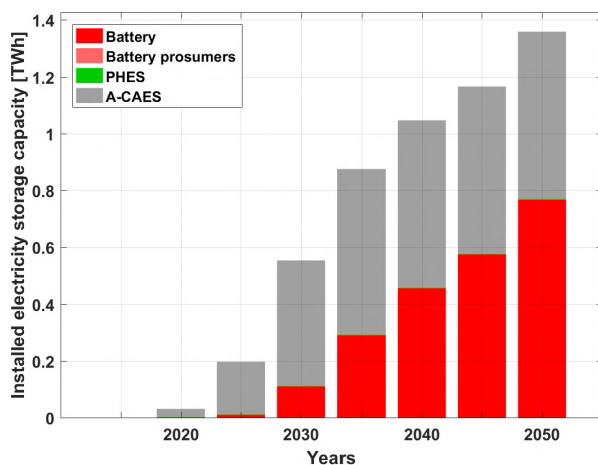

Figure 3.10-16: South America – Transport sector installed electricity storage capacity (left) and electricity storage output (right) during the energy transition from 2015 to 2050.

An essential aspect in the transition of the transport sector towards higher electrification completely based on renewable energy is the production of synthetic fuels, hydrogen and sustainable biofuels. As indicated in Figure 3.10-17, the installed capacities of fuel conversion technologies increase substantially from 2040 onwards to over 750 GW by 2050. Water electrolysis forms the majority share

of fuel conversion capacities through the transition. Additionally, heat is needed during the production of synthetic fuels, mainly for energy-efficient CO₂ direct air capture, and this is enabled by managing process heat, which is otherwise not useable. Heat utilisation is in the range of 375 TWh_{th} by 2050, which is comprised of excess heat and recovered heat, as shown in Figure 3.10-17.

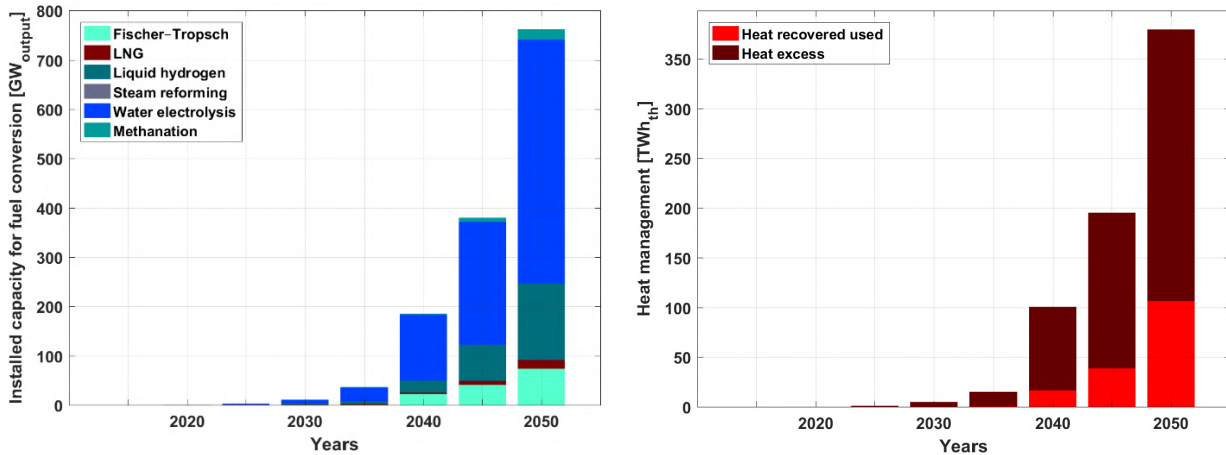

Figure 3.10-17: South America – Transport sector installed capacity for fuel conversion (left) and heat management (right) during the energy transition from 2015 to 2050.

Similarly, gas storage is necessary in the production of synthetic fuels. As shown in Figure 3.10-18, the installed storage capacities for gas increase through the transition to around 3.8 TWh by 2050. Hydrogen storage is the major gas stored through the transition, with a lower share for methane gas by 2050. CO₂ storage and CO₂ direct air capture, which are vital in the production of synthetic fuels, are installed from 2040 onwards. The installed

capacity for CO₂ storage and CO₂ direct air capture increases up to around 100 MtCO₂ by 2050, as shown in Figure 3.10-18. The major share of installed storage capacity is CO₂ direct air capture, which is on an annual basis as compared to CO₂ storage. Despite having a lower storage capacity, CO₂ storage has a substantial utilisation and correspondingly higher throughput.

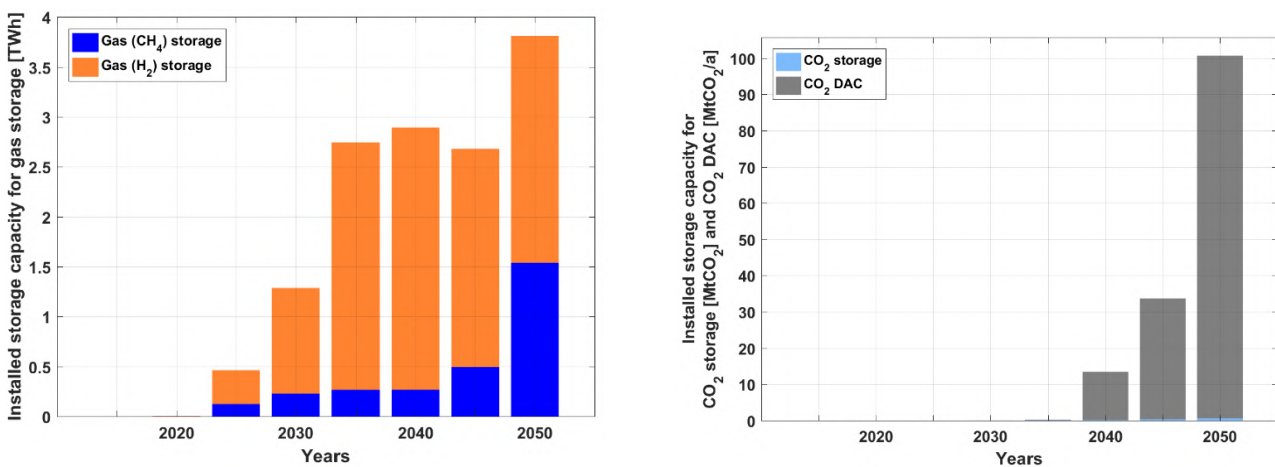

Figure 3.10-18: South America – Transport sector installed capacity for gas (methane and hydrogen) storage (left) and CO₂ direct air capture and CO₂ storage (right) during the energy transition from 2015 to 2050.

Fuel costs are a deciding factor in the overall energy mix for the transport sector across South America and their developing trends are highlighted in Figure 3.10-19. FT and SNG fuel costs decline through the transition up to 2050 and FT fuels are cost competitive with fossil liquid fuels including GHG emissions costs, at around 80 €/MWh in 2050. In addition, SNG is more cost effective than LNG in 2050. Electricity emerges as the most cost effective option with LCOE primary

at around 19 €/MWh and along with complementary costs of storage and other system components, total LCOE is around 26 €/MWh in 2050. H₂ fuel costs decline to be more cost competitive that fossil fuels, in the range of 47 €/MWh in 2050, while liquid H₂ is in the range of 56 €/MWh. CO₂ from DAC is a critical component for synthetic fuels at around 30 €/tCO_{2eq} in 2050, using waste heat, as shown in Figure 3.10-19.

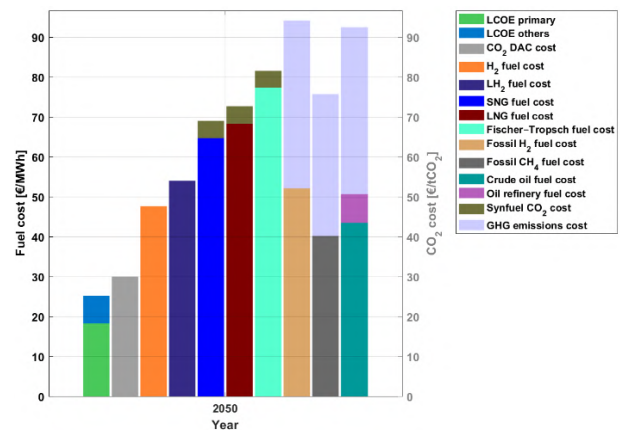
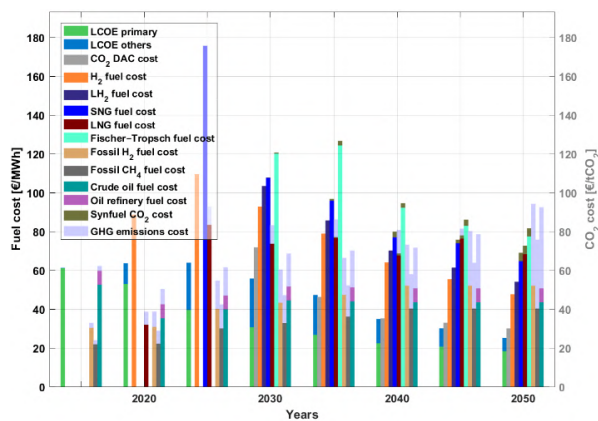

Figure 3.10-19: South America – Fuel costs for the transport sector during the energy transition from 2015 to 2050 (left) and fuel costs in 2050 (right).

The final energy costs for transport are in the range of 105-130 b€ through the transition period with a decline from around 125 b€ in 2015 to about 105 b€ by 2050, as shown in Figure 3.10-20. Furthermore, annual system costs transit from being heavily dominated by fuel costs in 2015 to a very diverse share of costs across various technologies for electricity, synthetic fuels and sustainable biofuel production by 2050, as

highlighted in Figure 3.10-20. The difference in annual final transport energy and system costs is predominantly due to additional aspects of the system beyond 2040, as FT units produce naphtha as a by-product, that adds to the overall system costs. The cost for naphtha is allocated to the industry sector as input for the chemical industry, since it is a valuable feedstock.

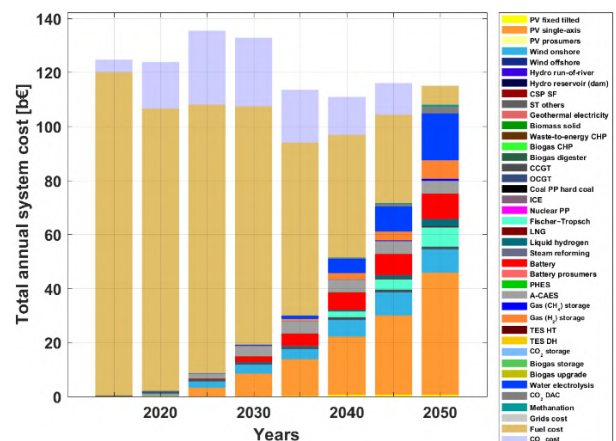
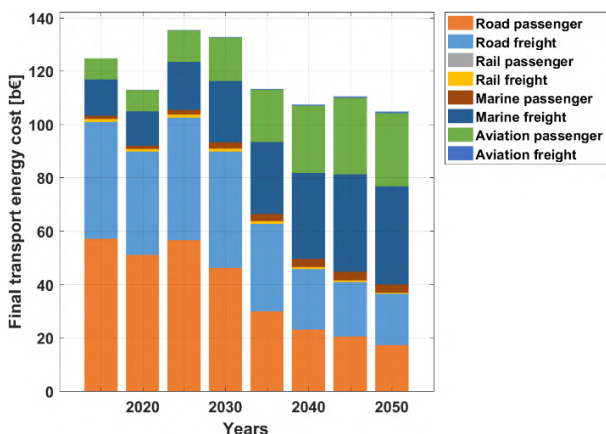

Figure 3.10-20: South America – Final transport energy costs based on mode of transport (left) and source of energy (right) during the energy transition from 2015 to 2050.

The final transport passenger costs decline from around 0.095 €/p-km in 2015 to over 0.055 €/p-km by 2050, as shown in Figure 3.10-21. Final transport passenger costs decline for road transport through the transition, whereas for marine and aviation there is a marginal decrease. Similarly, final

transport freight costs decline from around 0.055 €/t-km in 2015 to over 0.017 €/t-km by 2050, as shown in Figure 3.10-21. The final freight costs in the case of road declines through the transition, whereas it decreases slightly for rail and remains stable for aviation and marine.

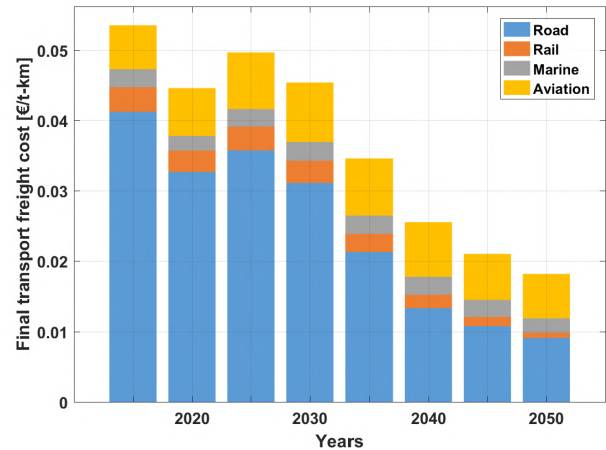
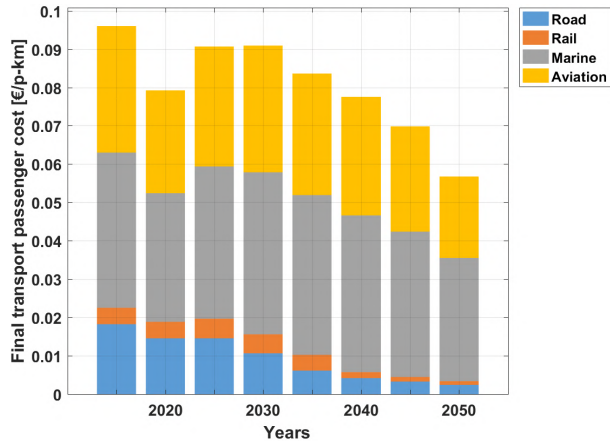

Figure 3.10-21: South America – Final transport passenger cost (left) and final transport freight cost (right) during the energy transition from 2015 to 2050.

Desalination

The desalination demand in South America is relatively much lower compared to other regions of the world. Therefore, the installed capacity of power generation for the desalination sector increases from around just 2 GW in 2025 to around

16 GW by 2050 as shown in Figure 3.10-22. Solar PV and wind comprise the majority of installed capacities from 2030 until 2050. Primary electricity generation to meet the desalination demand in the initial period of the transition is from fossil gas up to 2030, beyond which PV and wind dominate as highlighted in Figure 3.10-22.

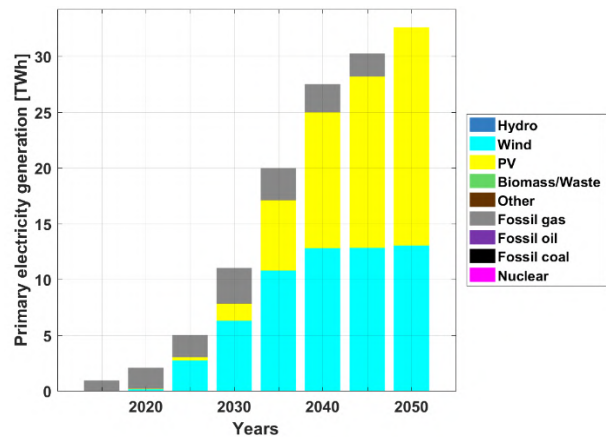
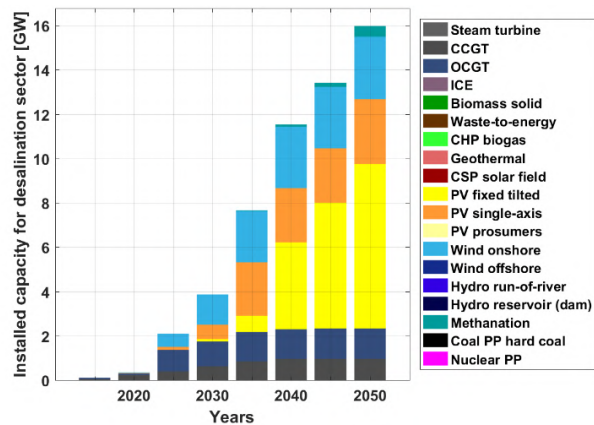

Figure 3.10-22: South America – Technology-wise installed capacities for the desalination sector (left) and primary electricity generation for the desalination sector (right) during the energy transition from 2015 to 2050.

The installed storage capacity for desalination occurs mainly from 2035 onwards, with most of the capacity added in the final five-year period until 2050, as shown in Figure 3.10-23. Gas comprises more than 95% of the 1.1 TWh installed storage capacity in 2050, whereas batteries contribute the majority of the storage output, which reaches more than 10 TWh_{el} by 2050 as shown in Figure 3.10-23.

Investments in power generation for the desalination sector occur mainly during 2025 onwards, as shown in Figure 3.10-24. A majority of the investments are in wind, PV, and batteries, which reach a high of over 3 b€ in 2035. The levelised cost of water increases marginally through the transition from around 0.9 €/m³ in 2015 to around 1.1 €/m³ by 2050, as shown in Figure 3.10-24.

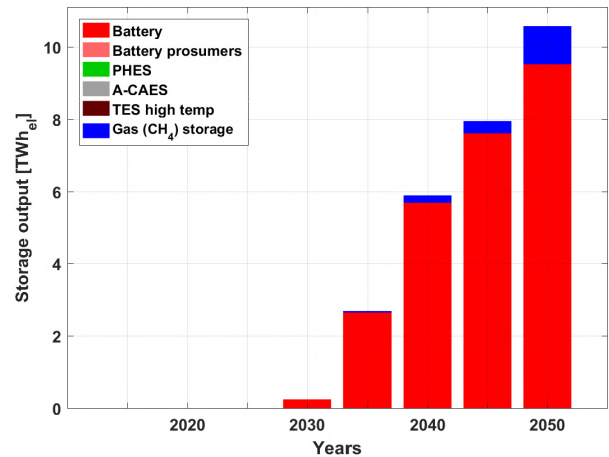
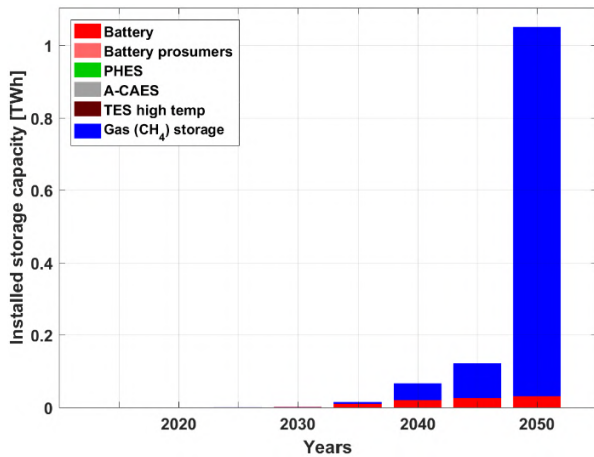

Figure 3.10-23: South America – Installed storage capacity (left) and storage output (right) during the energy transition from 2015 to 2050.

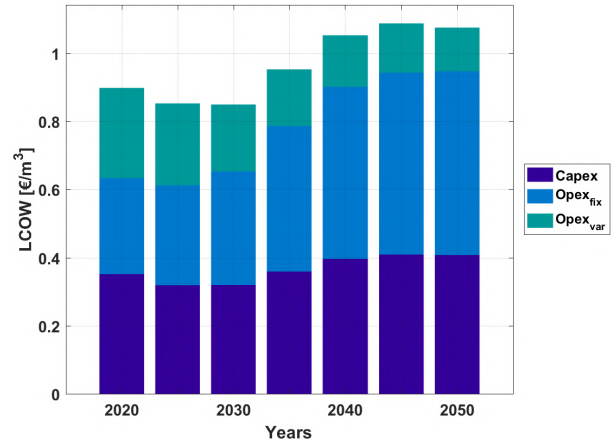
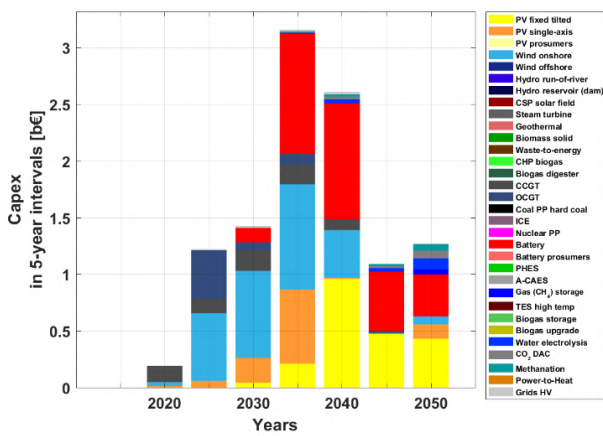

Figure 3.10-24: South America – Capital costs for five-year intervals (left) and levelised cost of water (right) during the energy transition from 2015 to 2050.

Regional Outlook

Electricity generation capacities are installed across South America to satisfy the demand for power, heat, transport, and desalination up to 2050. Solar PV capacities are predominantly in the northern regions of South America that have better solar resources through the year, while wind energy capacities are mainly in the southern regions of South America that have much better wind conditions and hydropower is predominant in the central regions of South America as shown in

Figure 3.10-25. Overall, solar PV and wind capacities along with some hydropower capacities constitute the majority of installed capacity in 2050 across South America. Similarly, higher shares of solar PV generation are in the northern regions and higher shares of wind energy are in the southern regions as highlighted in Figure 3.10-25. This could enhance the complementarity of solar PV and wind in an interconnected South American energy system.

Regional electricity capacities

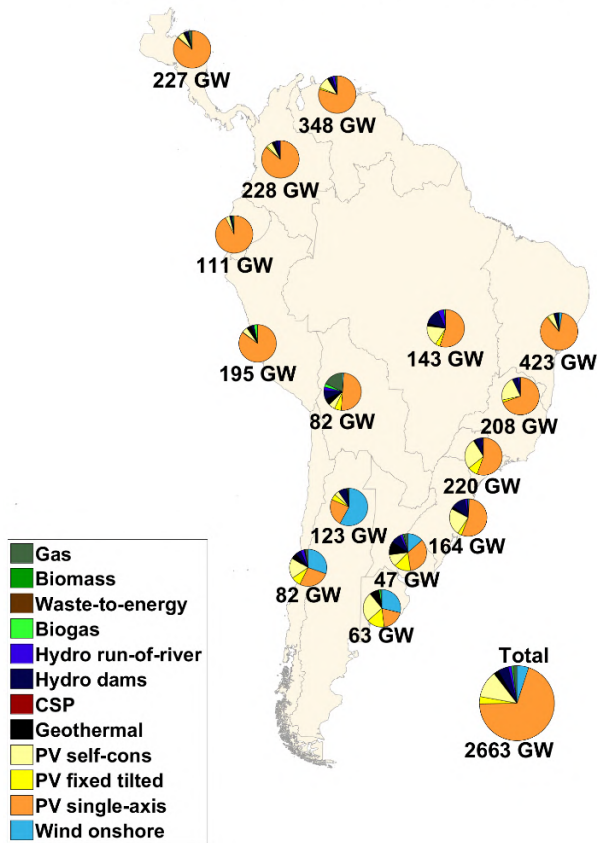

Regional electricity generation

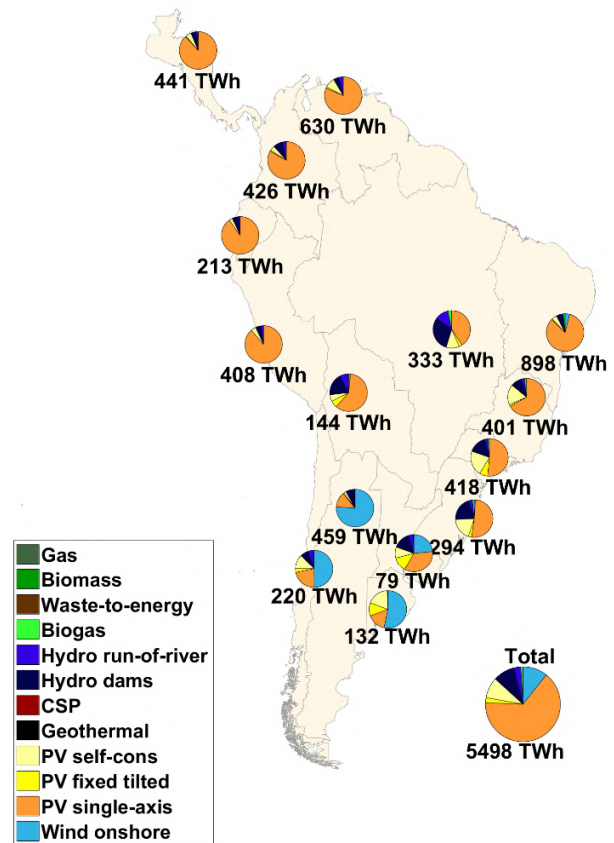

Figure 3.10-25: South America – Regional electricity generation capacities (left) and electricity generation (right) in 2050.

Solar PV capacities are well distributed across the different regions of South America and achieve a total installed capacity base of almost 2250 GW in 2050. Moreover, there are capacities across the regions and countries with good solar conditions throughout the year, as shown in Figure 3.10-26.

Whereas, wind energy capacities achieve a total installed capacity base of just over 135 GW in 2050 and are predominantly in the southern regions of South America, which have some good wind potential. This can be observed in Figure 3.10-26.

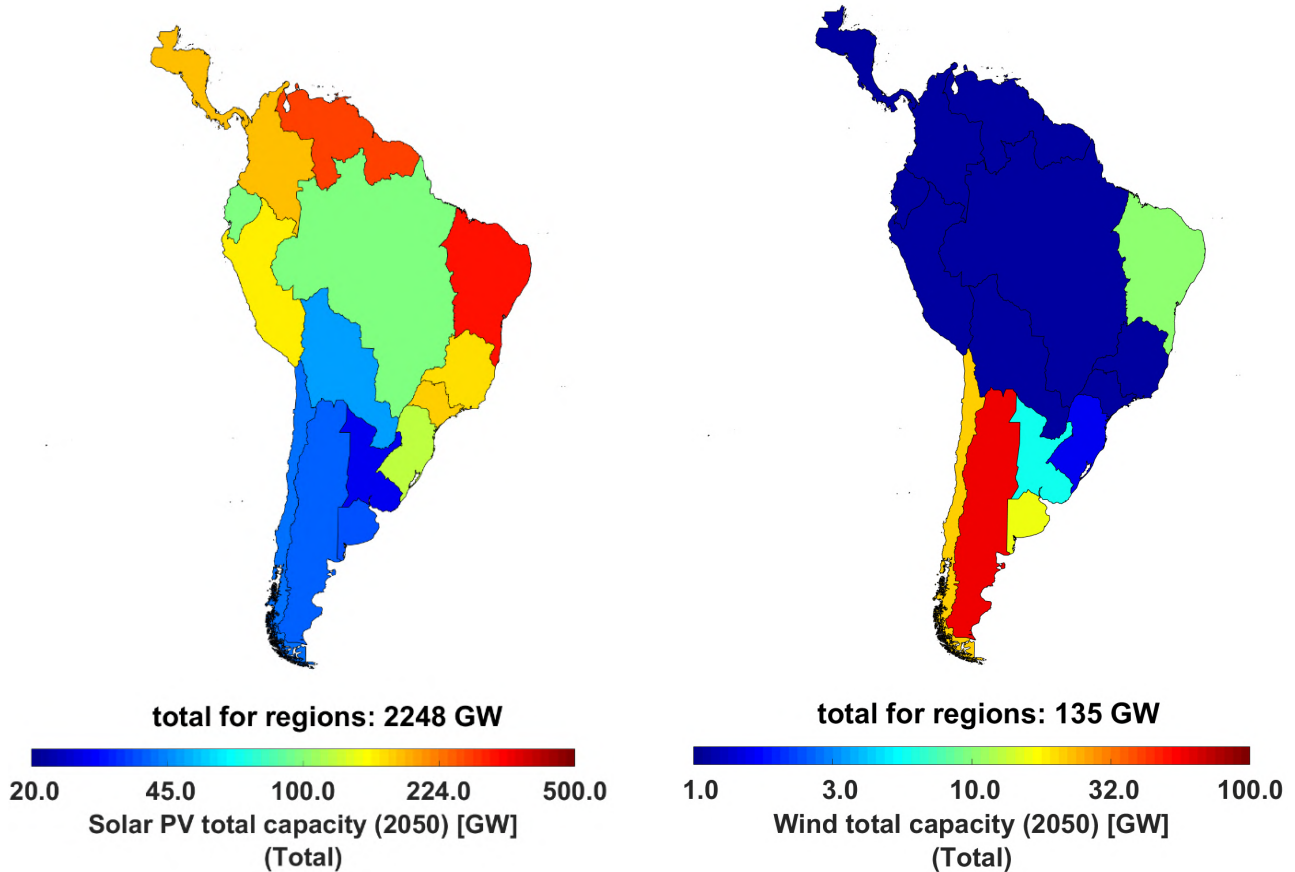

Figure 3.10-26: South America – Regional variation of electricity generation capacities of solar PV (left) and wind energy (right) in 2050.

The electricity generation across the power, heat, transport, and desalination sectors of South America are predominantly from PV, hydropower and wind in 2050, which are distributed across the region as shown in Figure 3.10-27. Solar PV, which supplies an average of 75.9% of electricity generation across South America, is more common

in the northern regions. While wind energy, which contributes an average of 10.9% of electricity generation across South America, is mainly found in the southern regions. Overall, solar PV and wind generate most of the electricity needed across South America by 2050, which is around 86.8% of total electricity generation.

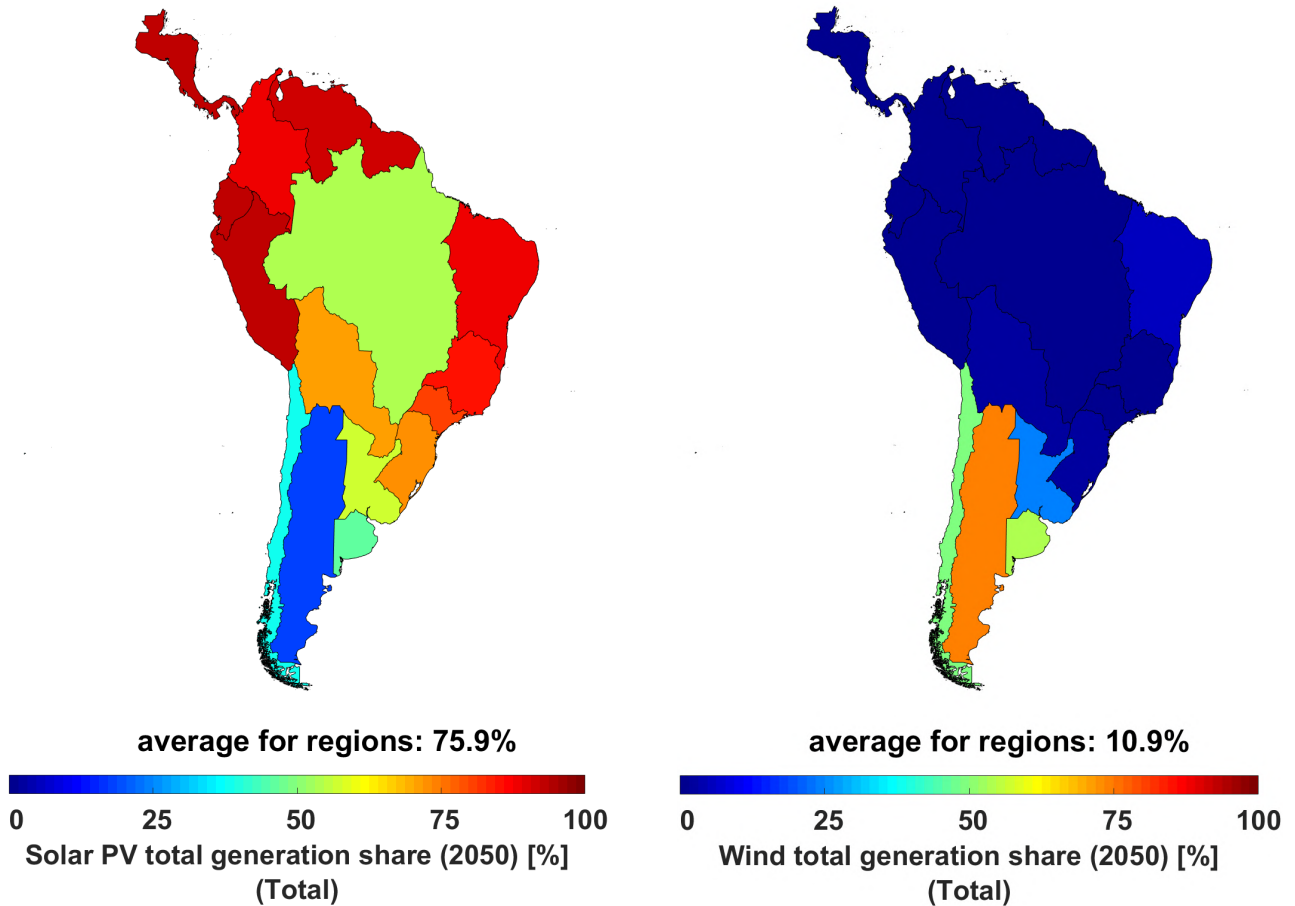
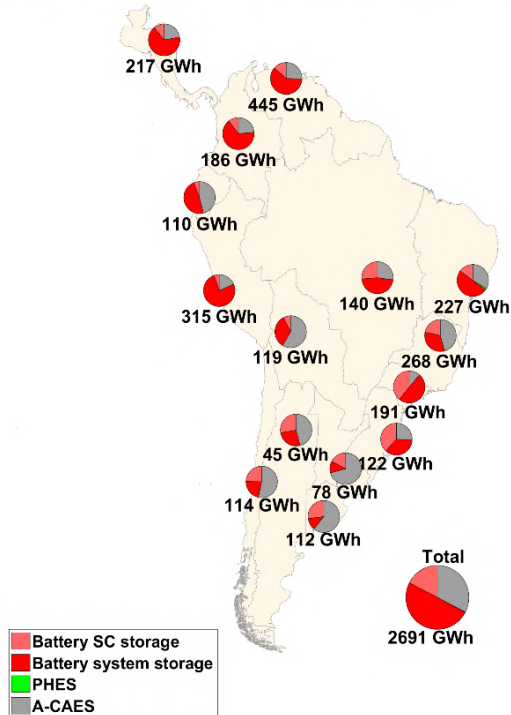

Figure 3.10-27: South America – Regional variation of electricity generation shares of solar PV (left) and wind energy (right) in 2050.

Utility-scale and prosumer batteries contribute a major share of electricity storage capacities, with some shares of A-CAES by 2050, as shown in Figure 3.10-28. Storage capacities are much higher in the northern parts of South America, to complement higher shares of installed solar PV capacities, compared to the southern regions.

Batteries, both prosumers and utility-scale, deliver the largest shares of output by 2050, as shown in Figure 3.10-28. A-CAES contributes complementary shares of electricity storage output through the transition, across the different regions of South America.

Regional electricity storage capacities



Regional electricity storage annual generation

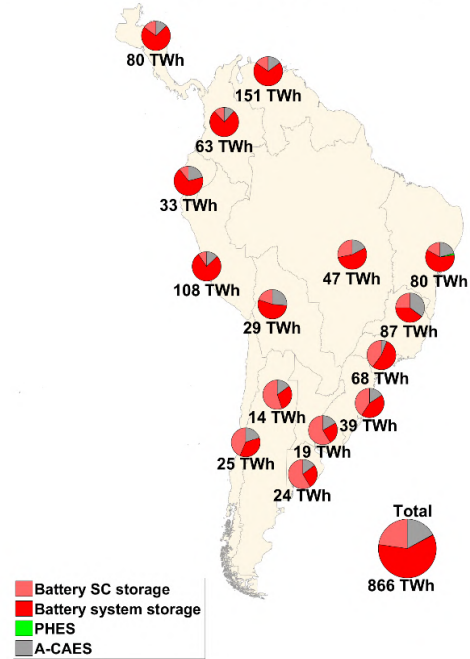

Figure 3.10-28: South America – Regional electricity storage capacities (left) and electricity storage annual throughput (right) in 2050.

The storage output across the power, heat, transport, and desalination sectors of South America is predominantly from batteries (both utility-scale and prosumers) and no synthetic natural gas supply in 2050, as shown in Figure 3.10-29. Batteries, which supply an average of 14.2% of the storage output across South America, are more common in the northern regions. Synthetic natural

gas supplies just a minor share of the storage, as hydropower provides the seasonal balance required and complements the high generation from PV and wind to reduce overall storage requirements. Synthetic natural gas as well as biomethane, together supply less than 0.1% of the total electricity demand in 2050 across South America.

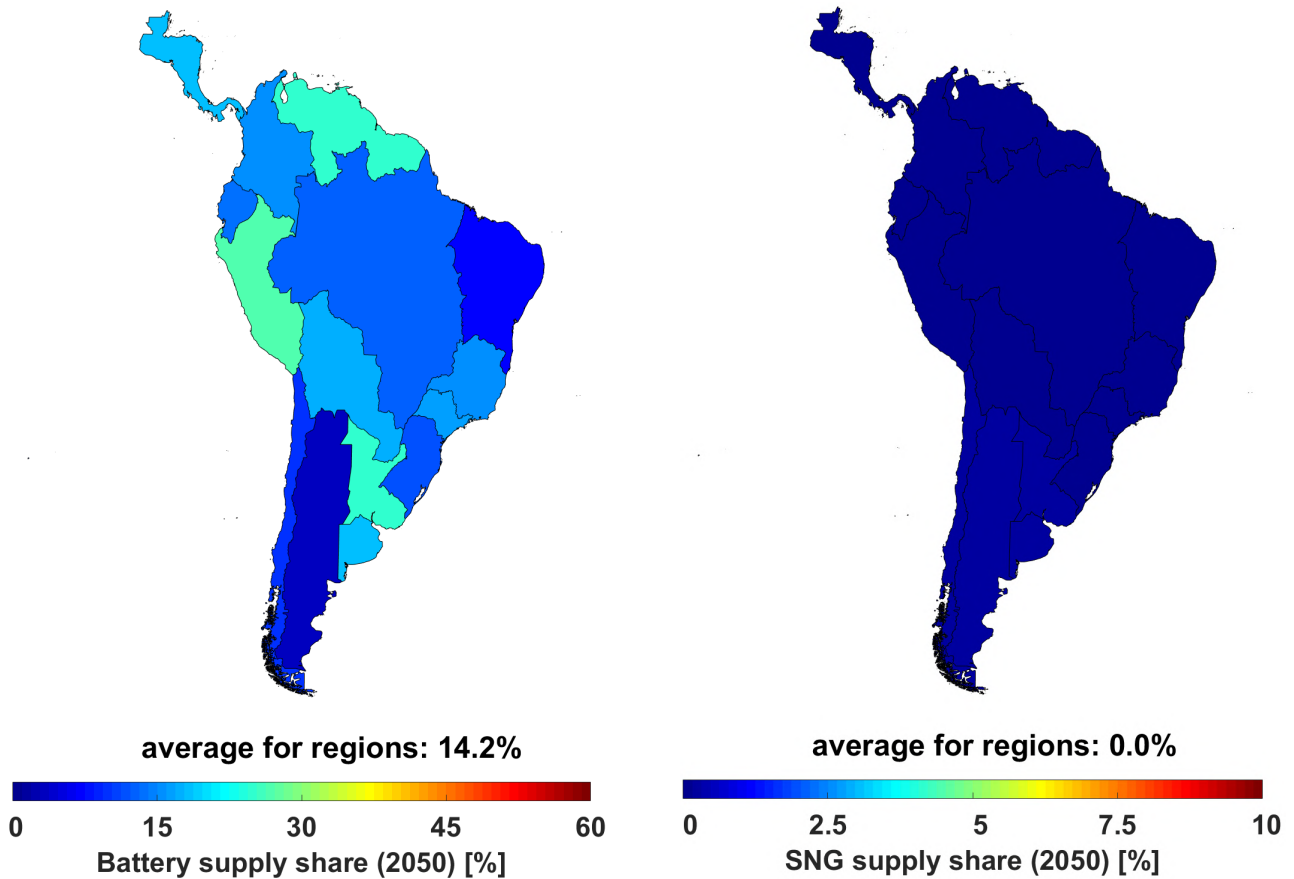

Figure 3.10-29: South America – Regional variation of storage supply shares of batteries (left) and synthetic natural gas (right) in 2050.

Greenhouse Gas Emissions

The results of the global transition towards a 100% renewable energy system indicate a sharp decline in GHG emissions until 2050, reaching zero GHG emissions by 2050 across the power, heat, transport, and desalination sectors in South America as shown in Figure 3.10-30. The power sector undergoes a deep decarbonisation by 2030, whereas for the heat and transport sectors this occurs mostly between 2030 and 2050. Moreover, the remaining cumulative GHG emissions comprise around 13 GtCO_{2eq} from 2018 to 2050. Therefore, the energy transition pathway for South America is

in adherence to the ambitious Paris Agreement target of 1.5°C.

GHG emissions from the power sector decline through the transition from around 200 MtCO₂ eq./a in 2015 to zero by 2050 (shown in Figure 3.10-31). Similarly, GHG emissions from the heat sector decline through the transition from over 170 MtCO₂ eq./a in 2015 to zero by 2050 (shown in Figure 3.10-31).

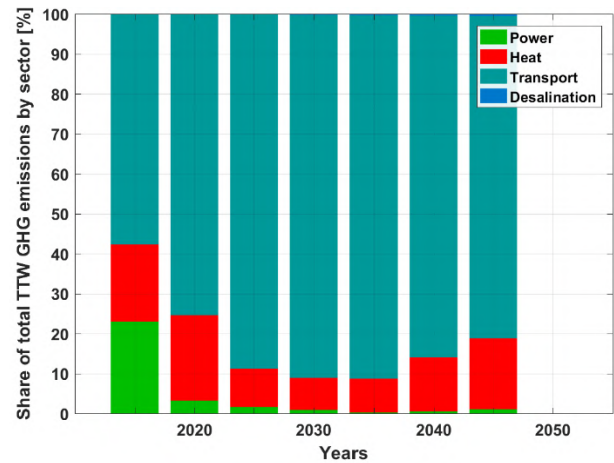
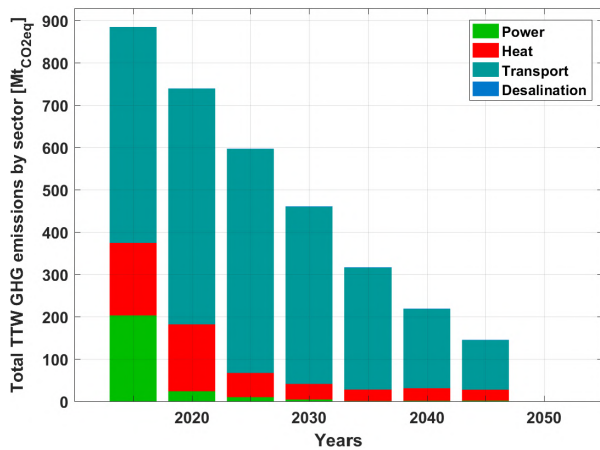

Figure 3.10-30: South America – Sector-wise GHG emissions (left) and the share of GHG emissions of different sectors (right) during the energy transition from 2015 to 2050. Tank to Wheel (TTW) considers GHG emissions from readily available fuels and does not consider GHG emissions from the upstream production and delivery of fuels.

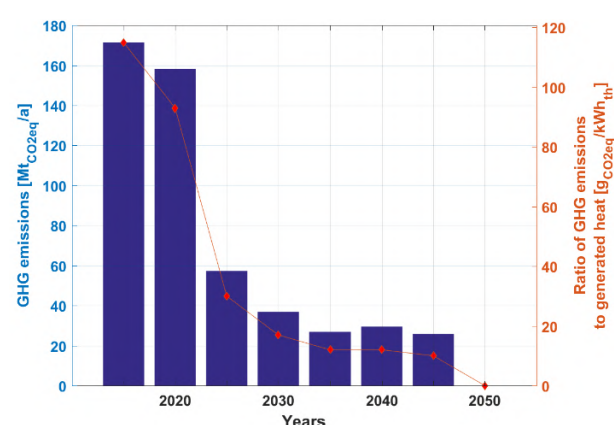
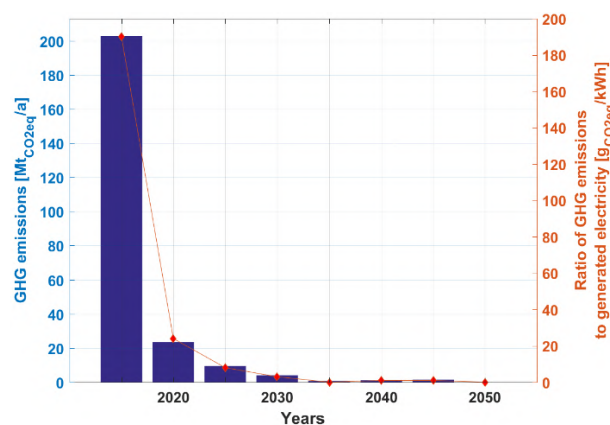

Figure 3.10-31: South America – GHG emissions in the power sector (left) and GHG emissions in the heat sector (right) during the energy transition from 2015 to 2050.

GHG emissions from the transport sector decline through the transition from around 500 MtCO₂ eq./a in 2015 to zero by 2050, as shown in Figure 3.10-32. Similarly, GHG emissions from the

desalination sector, which are much lower than those of other sectors, decline through the transition from around 0.7 MtCO₂ eq./a in 2015 to zero by 2050, also visible in Figure 3.10-32.

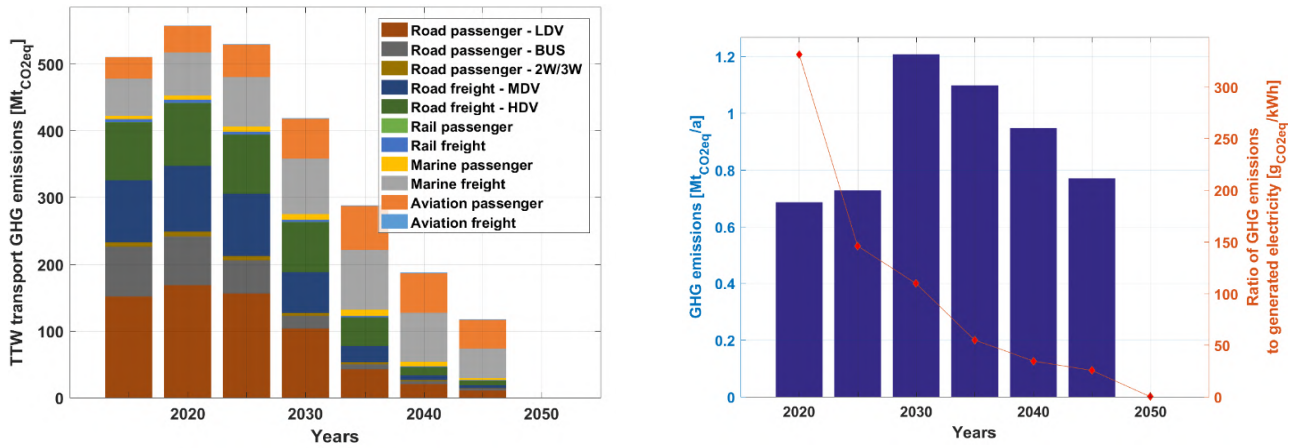

Figure 3.10-32: South America – GHG emissions in the transport sector (left) and GHG emissions in the desalination sector (right) during the energy transition from 2015 to 2050. Tank to Wheel (TTW) considers GHG emissions from readily available fuels and does not consider GHG emissions from the upstream production and delivery of fuels.

Jobs in the Power Sector across South America

The energy transition is seen to rapidly increase in the near future and continue through the transition period, with solar PV complemented by hydropower, wind and biomass emerging as the main sources of power generation by 2050. Likewise, jobs are predominantly created in the bio-power (827 thousand jobs by 2020) and hydropower (357 thousand jobs by 2025) sectors during the initial periods of the transition up to 2030 as shown in Figure 3.10-33. Beyond which, solar PV (930 thousand jobs by 2050) along with

battery storage (202 thousand jobs by 2050) emerge as the major job creators. Storage led by batteries create jobs from 2025 onwards and maintain a stable share (9% of total jobs in 2025) through the transition period until 2050 (12% of total jobs). Whereas, coal, gas and oil power generation associated jobs decline rapidly, almost disappearing by 2025. With the brisk build up in installations, the total number of direct energy jobs rise from just under 1 million to nearly 2.2 million by 2025 and a steady decline thereafter towards 1.6 million by 2050.

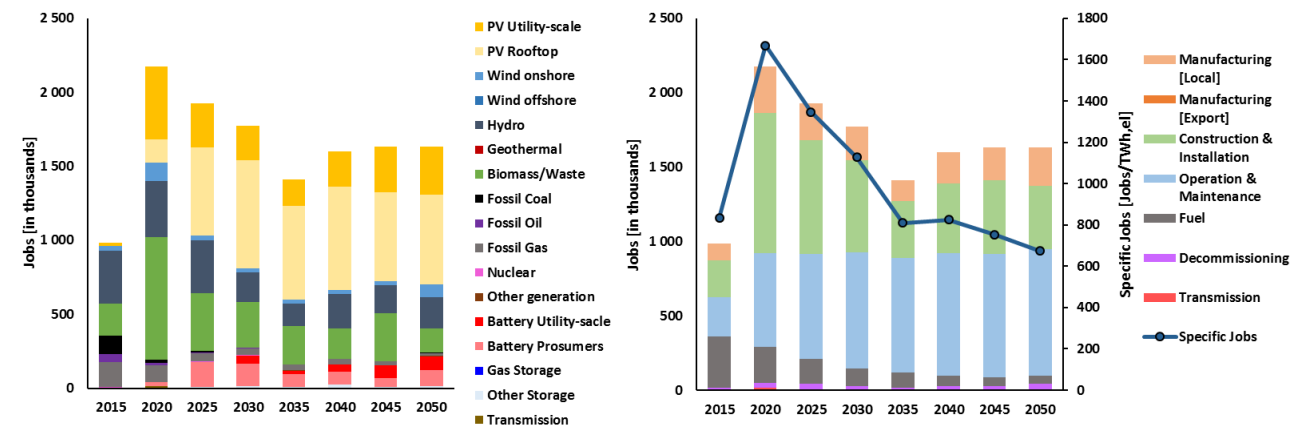

Figure 3.10-33: South America – Jobs created by various power generation and storage technologies (left) and jobs created based on different categories with the development of electricity demand specific jobs (right) during the energy transition from 2015 to 2050.

With rapid installation of power generation capacities in the initial period from 2020 to 2030, the majority of jobs is created in the construction and installation of power generation technologies with 40% of total jobs by 2025. Manufacturing jobs have a relatively low share in the initial periods with a high share of imports. Beyond 2030, the share of manufacturing jobs is observed to stabilise until 2050 (16% of total jobs), with increase in domestic production capabilities. The share of fuel related jobs continues to diminish through the transition period reaching just 3% of total jobs by 2050, as conventional power plants are replaced by renewable and storage technologies. By contrast,

the share of operation and maintenance jobs grows through the transition period with 52% of total jobs by 2050. A small share of decommissioning jobs with around 3% of total jobs by 2050, is created through the transition period with the continuous replacement of power plants at the end of their lifetimes. The electricity demand specific jobs rapidly increase from 835 jobs/TWh_{el} in 2015 to 1669 jobs/TWh_{el} in 2020 with the rapid ramp up in renewable energy installations. Beyond 2020, specific jobs decline steadily to around 674 jobs/TWh_{el} by 2050, as highlighted in Figure 3.10.-33.

4. Critical Features of the Global 100% Renewable Energy System

As this research indicates, a global 100% renewable energy system will not only ensure meeting the goals set by the Paris Agreement, which is achieving a very deep decarbonisation of the global power sector earlier than 2050 and achieving zero GHG emissions by 2050 across other energy sectors, but also bring about a multitude of socio-economic benefits to the global society^{79,80,81}. There are some critical features of this research study that are further highlighted.

Cost Optimal Energy Transition Pathway

A rapid and sustainable energy transition worldwide requires the global community to anticipate and shape future outcomes under the influence of a multitude of different factors including demand growth, resource availability and pricing, technology innovation, and new energy and environmental policies. Therefore, envisioning global energy transition pathways that consider a majority of the critical influencing factors are crucial in shaping opinions of stakeholders. Costs are always one of the key factors to influence decision making across the board, and therefore, cost optimal energy transition pathways have significant potential to influence policy and decision makers, who are mainly considerate about costs. This research is a first of its kind effort to present a global cost optimal energy transition pathway

through the transition period from 2015 to 2050 without compromising on the most important societal need, reducing global GHG emissions to zero before mid-century across the different energy sectors. This research unveils a major saving of energy system costs by the transition towards 100% renewable energy in many regions. In general, the levelised cost of energy of a 100% renewable energy system remains in an affordable range of 40-80 €/MWh around the global average cost of 54 €/MWh across the different regions of the world in 2050, as indicated in Figure 4-1. Moreover, a vast majority of the regions have levelised cost of energy in the range of 45-55 €/MWh often achieving both full climate compatibility and cheaper energy than today.

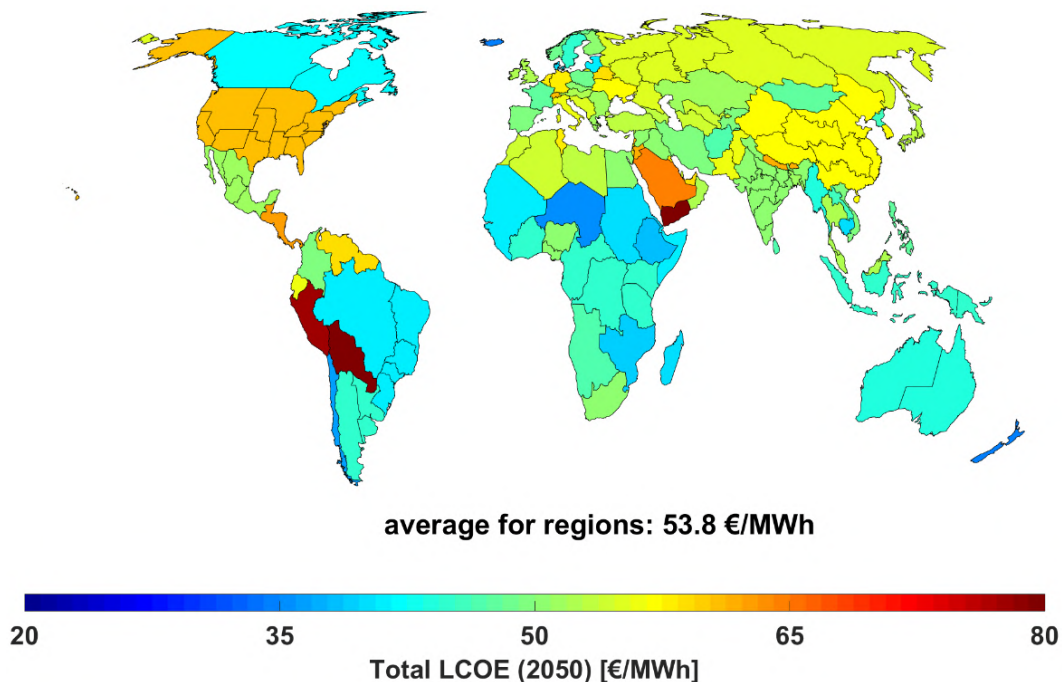

Figure 4-1: Regional variation of the levelised cost of energy on a global scale in 2050.

Electrification of Energy Services

A paradigm shift is observed, wherein electricity emerges as the ‘energy carrier’ of the future, replacing fossil fuels. In a highly digitalised future with strong global climate policies, electrification of energy services will be pervasive⁸². Primarily, fossil and nuclear fuels used in the power sector are substituted by technologies directly extracting electricity from the environment, in particular solar PV and wind energy. As highlighted by the results, electric vehicles will largely replace fossil-fuelled 2-wheelers, 3-wheelers, cars and trucks. Moreover, heat pumps and electric heating substitute oil and gas furnaces in buildings and industries. In addition, electricity from renewables are used to produce hydrogen and other synthetic fuels for applications where direct electrification is challenging. The advantages of widespread electrification are clear and compelling. Substantial efficiency gains are observed throughout the different regions of the world in terms of TPED. An average of around 49% gain in primary energy demand is estimated globally by 2050, as shown in Figure 4-2. Moreover, this varies substantially across the different regions of the world, with most regions gaining between 40-60% as a result of high electrification across the energy sectors. Regions of already high renewable

electrification gain less, for instance Norway, whereas regions with least efficient energy systems gain most, e.g. oil-rich Libya and Saudi Arabia. Solar-rich Africa, which is yet to develop most of its energy infrastructure can leapfrog into a highly electrified energy system of the future (see Figure 4-2).

The critical question that remains is how the implementation of these technologies occur across the different regions of the world and at what pace. The most important and very first step is a fast and comprehensive phase out of inefficient thermal power plants across the world. We find that the electrification of the transport sector will proceed in three major phases. Firstly, direct electrification across the different modes mainly led by road transport occurs till about 2030. Second, a broader indirect electrification through the production of FT-fuels occurs across the different transport modes. Finally, more usage of liquefied gases (CH₄, H₂) in the 2040s is observed across the sector mainly for long-distance heavy-duty transport modes, such as marine and aviation. This projection leads to zero GHG emissions in the transport sector by 2050 across the world.

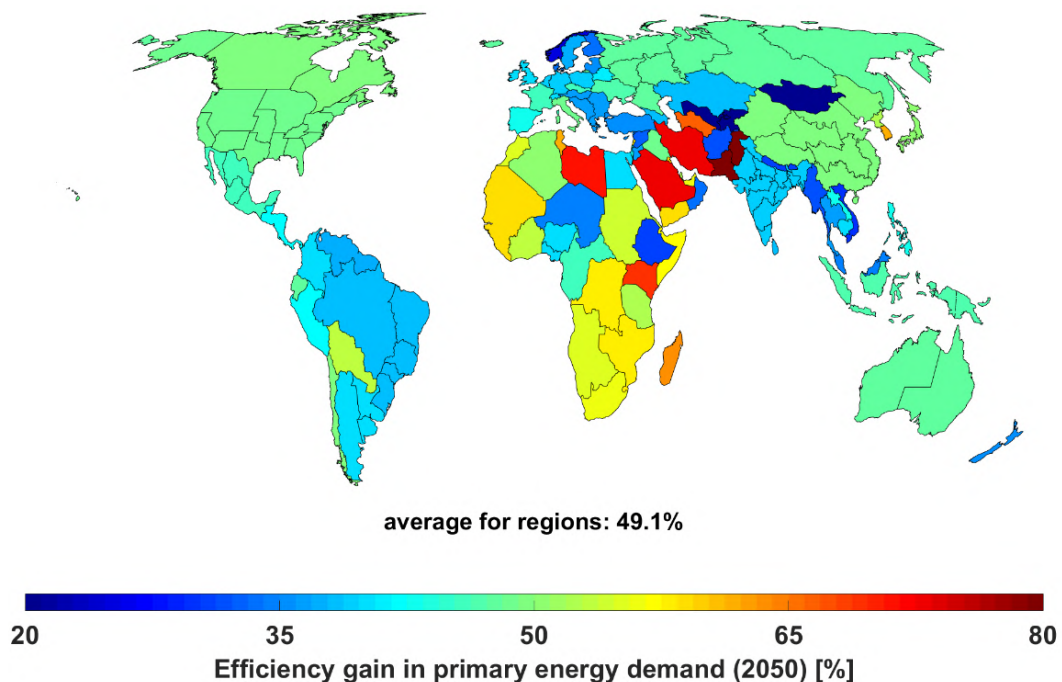

Figure 4-2: Regional variation of efficiency gains in primary energy demand on a global scale in 2050.

Synthetic Fuels

There is no place for fossil fuels in a fully sustainable energy system, if the goals of the Paris Agreement are to be realised. As highlighted by the results for 2050, a zero GHG emissions global energy system can be achieved across the power, heat, transport and desalination sectors. Additionally, it is evident that a complete substitution of hydrocarbons by renewable electricity is not possible, as electricity cannot be directly used in some sectors such as aviation (for long distance flights) or marine in many cases. Thus, renewable electricity based synthetic fuels are essential to fulfil this demand. FT-fuels, hydrogen and liquefied gases (methane and hydrogen) are a viable alternative to fossil fuels by 2040 and have a vital role through the transition. Furthermore, as highlighted earlier, regional variation of production costs of these fuels have been factored into the cost optimal energy

transition pathway. As indicated in Figure 4-3, production costs for FT-fuels vary significantly across the different regions of the world with a global average cost of nearly 86 €/MWh in 2050. FT-fuel costs in Europe are higher due to a decentralised and localised approach to the production of FT-fuels, whereas an integrated European production of FT-fuels will most likely reduce the costs. For most parts of the world the costs are observed to range from 75-85 €/MWh. In addition, costs are observed to be extremely low (60-65 €/MWh) in South America (mainly the Patagonian region) and China, which could become future hubs for FT-fuels production (see Figure 4-3). Excellent complementarity of solar and wind resource conditions is the main driver for reducing production costs of FT-fuels, as can be observed for the region of Patagonia, the Horn of Africa, Yemen and China (see Figure 4-3).

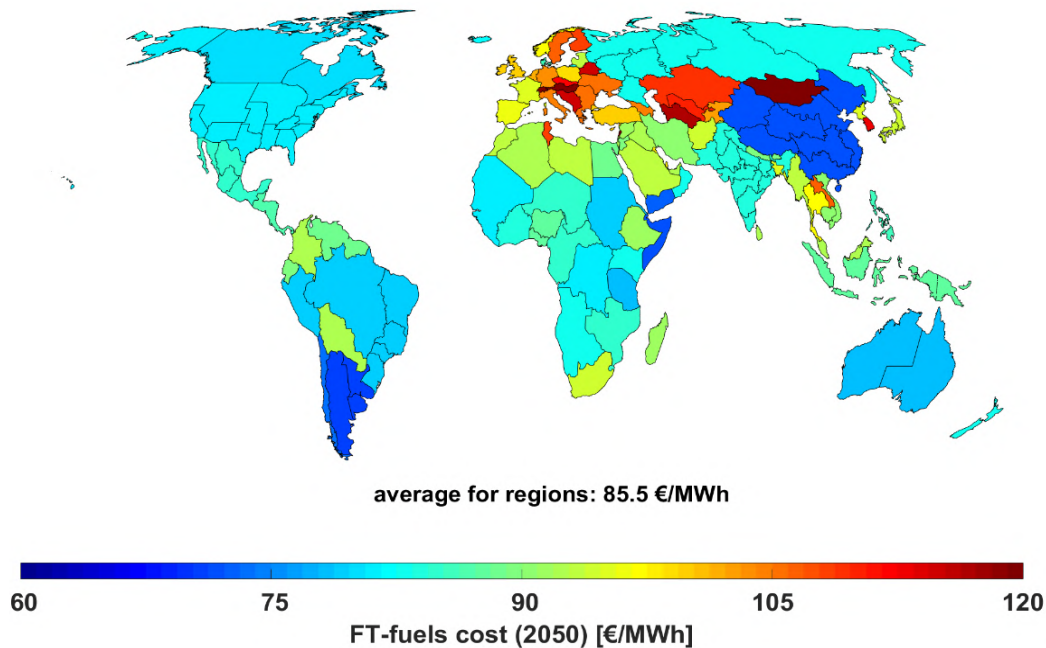

Figure 4-3: Regional variation of FT-fuels costs on a global scale in 2050.

A critical integration of the production process of synthetic fuels with renewable energy generation along with innovative heat management increases the overall flexibility of the transport sector and reduces the need for curtailment and storage technologies. The curtailed electricity generation potential achieves a global average value of 2.4% in 2050 for the transport sector. In the least cost solution in 2050 for a 100% renewable energy system, the corresponding value in the fully integrated power and heat sector is 5.4% and for the separated power sector 7.2%⁴⁶, which would be the least cost solution in 2050 for a 100% renewable energy system. In comparison to the integrated power and heat sector, the transport sector requires lesser storage for electricity, with 12.3% of generated electricity being stored, compared to 28.3% for the integrated power and heat sectors, and 27.2% for the separated power sector highlighted in Ram et al.⁴⁶. A further integration of the transport sector with the power

and heat sectors is most likely to result in greater flexibility and reduce overall system costs, also due to lesser curtailment and lesser storage demand, making an integrated 100% renewable energy system even more cost effective.

DAC technology is increasingly being seen as a viable negative CO₂ emission technology option^{42,83}. As further highlighted by the results, DAC plays a key role in the production process of synthetic fuels. Moreover, DAC has several key features, in particular a very good area footprint for large-scale deployment, no major conflicts with land use, and an excellent match to the renewables based energy systems of the future⁸⁴, which are mainly based on solar PV and wind energy as highlighted by the results. This technology can be further pursued to enable higher levels of carbon capture and utilisation and also in processes where carbon can be utilised as an input product, which will boost mitigation efforts in achieving the goals of the Paris Agreement.

Local Resource Driven Energy Systems

Another critical aspect of this research is capturing the regional variation in energy systems across the world through the transition period. Renewable energy resources are well distributed around the world, but different resources are available in

different proportions, across regions. Therefore, the results of this research enable energy transition pathways that maximise utilisation of locally available renewable resources in a cost optimal manner, as indicated in Figure 4-4.

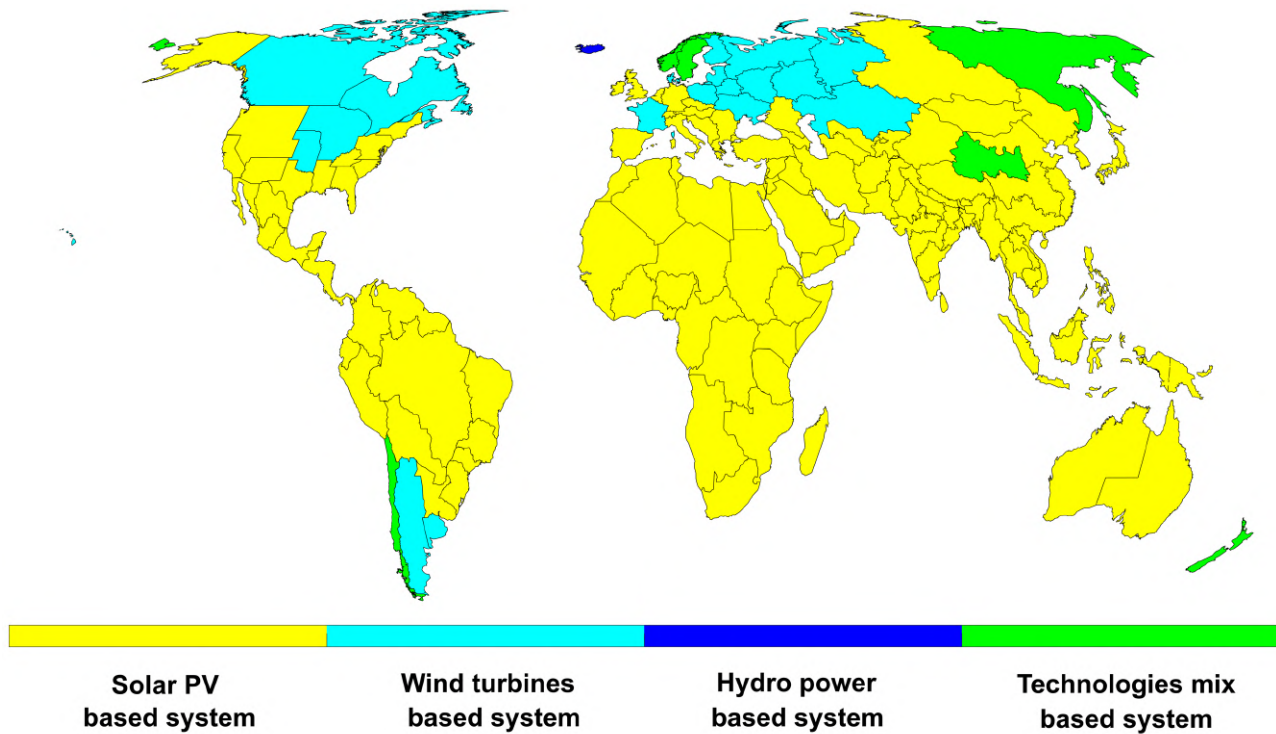

Figure 4-4: Variation in the regional energy mix for power, heat, transport and desalination sectors on a global scale in 2050.

Moreover, the results provide regional insights into energy systems from a global perspective. For instance, the Northern hemisphere utilises relatively higher shares of wind energy as compared to the Southern hemisphere, where solar PV is rather predominant. Furthermore, Eurasia along with some regions in Europe and North America utilise a high share of onshore wind energy across the northern regions. Hence, many regions in Eurasia are wind dominated (see Figure 4-4). Additionally, Canada and some parts of the USA are dominated by wind energy. Notably, in the Southern hemisphere wind energy dominates only in the Patagonian region of Argentina. By contrast, in most of the regions and countries of the world low-cost solar PV is leading as highlighted by Figure 4-4. By 2050, the highest generation share of solar PV among regions is in SAARC with more than 95% in its cost optimal generation mix, whereas SSA

utilises 82% share of electricity from single-axis PV in its cost optimal generation mix. Only Iceland is dominated by hydropower in 2050. Notably, some regions including New Zealand, Chile, Mongolian region of Northeast Asia, Nordic region and western Eurasia have a mix of renewable energy technologies with solar PV, wind energy and hydropower playing substantial roles (see Figure 4-4).

Similarly, from a heat supply perspective Eurasia has the most attractive techno-economic conditions for the application of heat pumps in the heating sector, providing about 60% of heating demand by this technology from 2030 through 2050. Other regions that cover a large part of the heating demand with heat pumps by 2050, are Europe with 51%, North America with 50%, Northeast Asia and Sub-Saharan Africa with 45% respectively.

Decentralisation

The LUT Energy System Transition modelling tool is applied in particular to investigate whether a higher level of decentralisation of energy transition pathways contributes to lower costing solutions. More precisely, the simulations have been carried out for 145 regions of the world, and show that regional energy demand can be fully met by utilising locally available renewable energy resources. The modelling of this research has been framed intentionally on national scales with further regional insights derived from sub-national regions. Additionally, research on the cost-benefits of interconnecting regions can be derived from scenarios with interconnections in a given major region or continent. This research clearly shows that 100% renewable energy supply is technically feasible and economically viable on a national level. Implying that a stronger cooperation among neighbouring countries or on an international level could further reduce the total energy system costs and even improve the already attractive economics.

Biomass for Cooking

The heat demand from biomass for cooking has been estimated across the 145 sub-regions of the world. In addition, a transition from biomass cooking towards cost effective electric cooking based on renewables has been included as part of

This has been shown in other research for the case of Europe, where the fully decentralised national 100% renewable energy solutions for the power sector showed a further cost reduction potential of 9% of the total system cost compared to a fully interconnected European power system ⁸⁵. However, the cross-border traded electricity did not exceed 12%, i.e. 88% of all electricity demand on a national level was generated locally, as part of a least cost solution for a fully interconnected Europe ⁸⁶. Comparable findings of 11% cost reduction had been found earlier for such analyses for all 9 major regions, but not yet for a full energy transition. However, these were for 100% renewable energy systems based on 2030 assumptions ⁸⁷.

Furthermore, biomass for cooking as part of heat demand and prosumers covering a share of the power demand are considered to enhance the decentralised aspects of the energy transition.

the energy transition pathway. Not only does this contribute towards mitigation of emissions but brings about several health benefits as well as reduces the stress on land use for biomass cultivation.

Prosumers – Power and Heat

PV prosumers may be one of the most important enablers of the energy transition. As indicated by the results, PV prosumers account for a significant share of the total installed solar PV capacity across the different regions of the world, which is a growing trend for the assumption of increasing retail electricity prices through the transition. This is further highlighted by the Figure 4-5, as countries with high retail prices for electricity have higher shares of electricity generation from PV prosumers as compared to countries with lower retail electricity prices. This can be noticed with the stark difference in the shares of PV prosumer electricity in most European countries with high shares, whereas Russia and adjoining countries which have very low retail electricity prices (that are heavily

subsidised) have much lower shares of electricity from PV prosumers (see Figure 4-5). Furthermore, despite excellent solar conditions, different countries in Africa have different shares of PV prosumer electricity. However, stable retail prices on present levels may most likely trigger full PV prosumer roll-out in most regions of the world, mainly due to cost decline in solar PV and battery. In addition, the global average generation share of PV prosumers is nearly 19% in 2050. Similarly, individual heat production contributes a fair share of the heat generation across the different regions of the world in 2050. This constitutes mainly solar PV driven space heating and domestic hot water demand using individual heat pumps and heating rods.

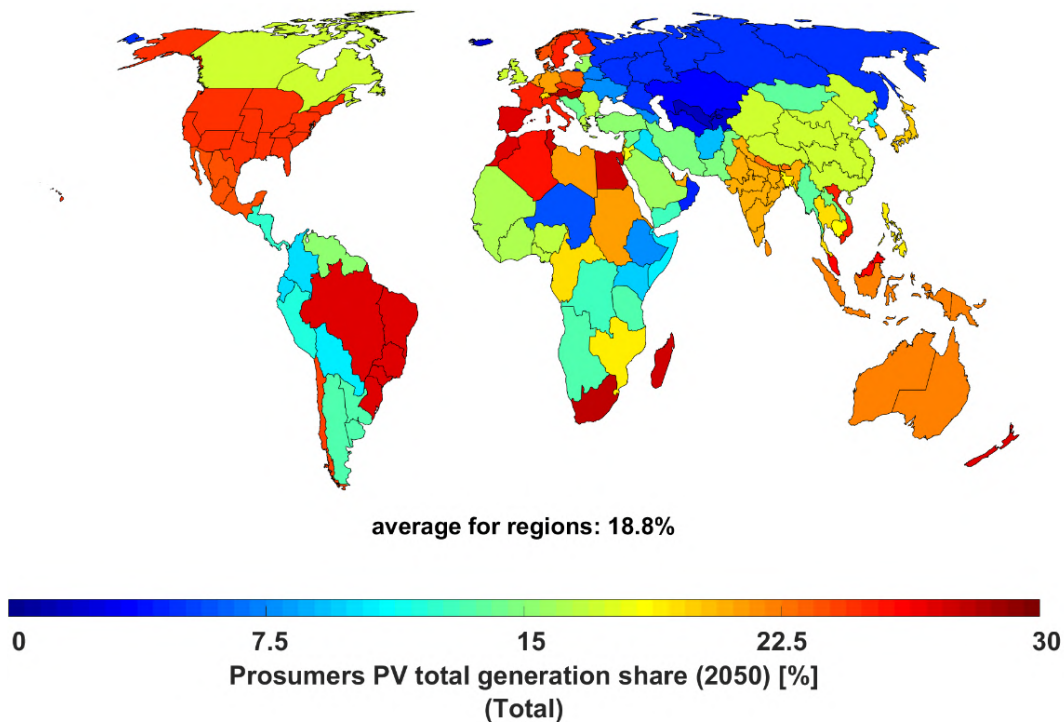

Figure 4-5: Regional variation of the share of electricity generation from PV prosumers on a global scale in 2050.

A fair, inclusive and just Energy Transition

Climate mitigation is the most important issue of current times, the urgency was heightened by the findings of the IPCC ¹, which stated that extra warming on top of the approximately 1°C we have seen so far would amplify the risks and associated impacts, with implications for the world and its inhabitants. The daunting task of limiting warming to 1.5°C would require transformative systemic changes, integrated with sustainable development across the world. Such changes, require a massive upscaling and rapid acceleration of the implementation of far-reaching, multi-level and cross-sectoral sustainable energy technologies, as highlighted by the results of this research. The remaining carbon budget is defined as the cumulative GHG emissions from 2018 until the time of net-zero global emissions, which is estimated to be 2050 in this research, but could be achieved well before 2050. The IPCC SR1.5 report ¹ recommends that cumulative CO₂ emissions should be kept within a budget by reducing global annual CO₂ emissions to net-zero and further suggests a remaining budget for limiting warming to 1.5°C with a 66% chance of about 550 GtCO₂, and of about 750 GtCO₂ for a 50% chance. In this context, this research shows that cumulative GHG emissions can be limited to 422 GtCO_{2eq} from 2018 to 2050 across the power, heat, transport and desalination sectors globally. GHG emissions from remaining sectors have to be added to the findings of this study, in particular from non-energetic industrial feedstock and land use. The energy transition pathway described in this study could be categorised as limiting peak warming to below 1.5°C by mid-21st century with greater than 66% probability. Furthermore, the power and heat sectors with cumulative GHG emissions limited to 225 GtCO_{2eq} from 2018 to 2050, are on a rapid decline pathway with deep decarbonisation until 2030. Whereas, the transport sector has lesser momentum with rapid change in the later part of the transition from 2040-2050 with cumulative GHG emissions limited to 193 GtCO_{2eq} from 2018 to 2050. But, if FT-fuels were to become economically attractive with favourable market conditions the transition in the transport sector could be further accelerated. In addition, the global desalination sector could yield cumulative GHG emissions of

just around 4 GtCO_{2eq} from 2018 to 2050, while increasing water provision by a factor of 40.

Energy transition pathways from high GHG emissions to low GHG emissions and finally zero GHG emissions energy supply, tend to focus on financial and economic implications, while broader social impacts are less regarded, such as job losses and local-scale economic activity form an integral part of embracing climate equity. In this context, this research has presented not only the GHG emissions pathway with cumulative GHG emissions of around 422 GtCO_{2eq} from 2018 to 2050. In addition, the job creation pathway is presented with around 35 million direct energy jobs being permanently created across the power sector, an additional 15 million jobs more compared to the early phase of the energy transition to ensure jobs lost in the conventional energy industries are more than compensated. As indicated earlier, renewable energy resources are well distributed across the world and this will foster local energy development strategies leading to diffusion of energy resource conflicts. Moreover, with low-cost energy available throughout the different regions of the world, as shown by the results, prospects for greater economic activity is higher.

The phase-out of biomass for cooking will drastically improve the health conditions of people in least developed and developing countries, in particular women and children. Indoor air pollution leads to the highest energy-induced fatal casualties among all energy-related negative impacts.

Eventually, a global energy transition towards 100% renewable energy has the potential to uplift the standard of living for people in the global south, which has excellent solar conditions throughout the year and tremendous potential for adopting the energy technology of the future, which is solar PV as indicated by the results of this research. As most of the development across the regions is yet to take shape, shifting them towards sustainable energy infrastructure development presents the opportunity to leapfrog developed countries into a sustainable future. In the process global energy resource based conflicts can be mitigated and a pathway towards peace and increased welfare can be attained.

Future Research

This research study presents a first of its kind technology-rich, multi-sectoral, multi-regional and cost-optimal global energy transition pathway, which adheres to the Paris Agreement in limiting temperature rise to 1.5°C. However, this research can be further refined by several major improvements.

- The industrial sector is the last remaining major energy sector, which is not yet fully represented. The electricity demand, heat demand and transportation demand for industrial activities are included in this research, however, industrial feedstock for non-energetic use is still missing. This is described in more detail in the next section.
- Land use as natural climate mitigation, in particular for natural climate solutions represents a major next step to better cover the soft negative CO₂ emission options for a comprehensive investigation of 1.5°C pathways, or even the requirements for re-balancing near a 1.0°C target for real sustainability and not only acceptable negative impact limitation, which is finally implied by the 1.5°C target.
- Negative CO₂ emissions technologies as part of the net zero emissions energy transition pathway require more investigation. This mainly addressed CO₂ DAC and carbon capture and storage (CCS), in short direct air carbon capture and storage (DACCS), and a subsequent gaseous CO₂ to solid matter conversion, i.e. carbon as a solid compound, chemically inert and in a form that is characterised by a very high combustion point. Such model expansion is then to be used to contribute to the discussion on bioenergy carbon capture and storage (BECCS) vs DACCS.
- A high level of decentralised energy system solution is implied by not enabling cross-border integration of energy systems, in particular in electricity generation and exchange. This could reduce the electricity-related costs by further 10% and reduce electricity generation capacity and storage needs, while increasing power transmission capacities.
- A substantial higher level of flexibility is possible in the transport sector with enabling smart charging and vehicle-to-grid for light duty vehicles, which represents the largest demand share of all road transport. In the present research, dump charging is assumed for all road vehicles as a most conservative limitation of a fully sustainable transport system.
- The present research can be characterised by semi-coupled sectors. The power and heat sectors are fully integrated and already show positive effects in reduced curtailment, as compared to an isolated power sector. Integration of the desalination sector into a full cross-sectoral integration does not provide much additional flexibility, as shown in other research⁸⁸. The transport sector benefits from all integration of electricity generation and storage components with synthetic fuel production components, however, the additional high level of available flexibility, in particular form water electrolyzers may be very beneficial, also for the sectors of power and heat. Thus, full sector coupling would provide more flexibility to the entire energy system, which would lead to further cost reductions.
- International and regional synthetic fuel trade is most likely a means of reducing the total system costs. In the presented research, all countries have to fulfil their entire energy demand on their own, as an intentional scenario assumption, showing that there is no need to wait for others. Nevertheless, in some regions of the world, exceptionally excellent solar and wind energy resources lead to globally most attractive synthetic fuel production costs. An energy system transition model, which allows global trade of synthetic fuels similar to the present fossil fuel trade, will further reduce the global energy system costs.

- Off-grid and rural electrification is not yet directly addressed in the present research. The three main electrification options are solar home systems, RE-based mini-grids for village and smaller towns' electrification and grid expansion. Electrification can be classified in Tier 1 (first basic electrification) up to Tier 6 electrification (OECD standard). A respective model expansion would cover the full transition of Tier 1 to Tier 6 and also monitor the energy system structure in on-grid and off-grid electrified population.
- The current resolution of the LUT Energy System Transition model with 145 sub-regions across the world is the most resolved global energy transition model available. However, a more comprehensive global-local model should be structured into 600 to 800 sub-regions, as this would allow actual local and sub-national energy transition modelling and thus would further facilitate sub-national discourse on energy transition options. Such a higher resolution is well doable with the LUT Energy System Transition model, as shown for the cases of Turkey ⁸⁹, Nigeria ⁹⁰, Western Africa ⁹¹, Iran ⁹², Pakistan ⁹³, Bangladesh ⁹⁴ and South Africa ⁹⁵. Current research for higher resolved sub-regions is targeted for Finland, Indonesia, Nepal and Bhutan, Sri Lanka, Ghana, Chile and Bolivia. Having the entire world on such a high resolution would also allow to trace the 50 to 100 largest urban centres with their energy transition pathway options.
- The present model covers the energy transition pathway options from the year 2015 to 2050. For more comprehensive investigations, coverage of the entire 21st century up to the year 2100 is required, also done by most Integrated Assessment Models used for climate change related research and presented in the IPCC SR1.5 ¹. Such a model expansion allows for a much higher certainty in the targeted temperature levels, whether it is 1.0°C, 1.5°C or 2.0°C, allowing for better tracing of circular economy aspects, such as material recycling and investigation of material resource limitations. Also, a better estimate of the energy demand of humankind in a balanced, but highest developed state.
- In addition, the energy transition pathway should consider a cradle-to-cradle approach of managing raw materials for the new technologies of a 100% renewable energy system.

Industrial Sector

The industrial sector in total accounts for around 25% of total energy use and 18% of global CO₂ emissions. Within this, the most important sectors are cement, iron and steel, and chemicals, which together account for about 5.6 GtCO_{2eq} of GHG emissions in 2015. Therefore, including these sectors as part of the energy transition pathway is necessary in determining net zero emissions pathways. Some key aspects of these sectors are as follows:

- **Cement:** The key drivers for defossilisation of the cement industry will be the substitution of fuels, mainly by waste and hydrogen, or direct use of electricity for heating. Remaining CO₂ from the limestone feedstock could be used as input material through carbon capture and utilisation (CCU) for power-to-hydrocarbons (fuels, chemicals). Initial research for the CCU and PtX potential of the cement industry is promising, so that the fossil fuel components can be phased out and the CO₂ emissions of the limestone part can be used for synthetic fuels and chemicals ⁴³.
- **Iron and Steel:** Similarly, for the steel industry, coal can be substituted by H₂, which could be generated in a sustainable way through renewables-based water electrolysis. The hydrogen direct reduced iron (H₂-DRI) is gaining attention ⁹⁶.
- **Chemical industry:** Almost all chemicals can be produced by initial synthesis with electricity, water and air. The major chemicals are ammonia and methanol, which can be converted to almost all other hydrocarbon-based chemicals. As chlorine synthesis is already electricity-based, it will be decarbonised when the power sector is decarbonised. Naphtha as a major by-product of synthetic FT-fuels is a valuable input chemical for the chemical industry and can be converted into many hydrocarbon-based chemicals.
- **Metal refining:** Major industrial metals, such as aluminium and copper can transition towards zero emissions processes adopting renewables.

Carbon Sinks and Negative CO₂ Emission Technologies (NETs)

Land use has been consistently ignored in energy system modelling, a few scenarios have considered them and showcase the benefits of natural climate mitigation. Moreover, land not only for sustainable agriculture, healthy diets and recreational uses, but also for carbon management could be a part of the net zero emissions pathway. The scenarios⁹⁷ that included land use demonstrated that it is a key part of how they reach net zero. Some of the aspects that deserve further consideration are the following:

Large-scale afforestation: the role of large-scale afforestation globally needs to be integrated. Taking into account the behaviour of the forests, carbon flux over time and corresponding system costs, the variation in carbon sequestration costs through afforestation. Furthermore, renewable energy powered desalination could be adopted to meet the irrigation demand of afforestation.

Sustainable Biofuels: Jatropha based plant oil seems to exhibit the best frame conditions to serve as a global strategy to produce sustainable biofuels for transportation as well as electricity and heat production, while fighting desertification, climate change, poverty and migration by rehabilitation

Cradle-to-cradle

The ecosystem consists of finite sources of non-energy raw materials, which are crucial for developing a global 100% renewable energy system. Further extracting these finite sources of minerals and metals to produce the relevant renewable energy generation and storage technologies could lead to a substantial increase in

and replanting of degraded soil at the same time⁶⁰. It exhibits enormous potential as a viable carbon sink. This is further discussed in detail in the following chapter.

Carbon soil sequestration: A similar approach could be adopted to understand the potential for carbon sequestration in soil through the growth of oil plants on degraded land. Moreover, the plantations could be irrigated with renewable energy powered desalination plants, which have been highlighted earlier.

NETs and long-term carbon storage: the applicability of storing CO₂ captured from NETs, such as BECCS and DACCS underground globally in geologic CO₂ storage, have to be further explored, while also getting useful products in the process. Additionally, the retrieved carbon is used to produce various products such as carbon fibre composites and Silicon Carbide that can partly replace existing building and other material but can be also used as long-term storage. Sustainable long-term carbon storage has to fulfil very high sustainability criteria, which includes storing of solid compounds that are chemically inert and have a very high combustion point.

demand as well as create potential environmental issues. Consequently, cradle-to-cradle approaches involving end-use recycling and material substitution could be crucial strategies that have to be integrated into net zero emissions pathways for the global energy transition.

5. Sustainable Jatropha Oil: Alternative Fuel for Semi-Arid Areas and Carbon Sink

The optimal technical and financial zero fossil fuel strategies by 2050 differ quite substantially between rich industrial regions and developing countries in Africa, Asia, and Latin America. With about 1.2 billion people living off-grid with electricity from diesel generators or no access to electricity whatsoever, these off-grid areas are characterised by an often hot, semi-arid climate, insufficient infrastructure, and a relatively poor and undereducated population. Consequently, centralised, energy-intensive, capital-intensive, and technically sophisticated industrialised energy storage and biofuel strategies are not suitable for energy and mobility purposes in these hot, semi-arid areas.

On the question of how these regions can phase out fossil fuel energy, a study was conducted by Gruber et al.⁶⁰, which concentrated on the global potential of plant oil as substitute to diesel fuel for balancing power in a 100% renewable energy hybrid systems. Among different oil plants, *Jatropha curcas* was examined. *Jatropha* oils from decentralised oil mills can supply a sustainable future biofuel from dryland areas in Africa, Asia, and Latin America. It is usable in adapted, advanced series diesel engines to power the demand for transport and electricity through the provision of balancing power together with solar PV, wind energy, and batteries within a 100% renewable global energy system.

However, the experience with biofuels as a renewable energy source has been highly controversial since its production interferes with food supply and ecosystem stability. In particular, the German "Biokraftstoffquotengesetz" (Biofuel Quota Act) from 2006 instigated an international shift to a diesel blend strategy with low cost palm oil, in turn imposing intense pressure on land use from food agriculture and rainforest to palm oil plantations. By 2050, it is forecast the world will have 9.7 billion inhabitants with a doubled demand for nutrition than today and increasingly problematic food production due to changes in the climate. Therefore, the food versus fuel problem as well as agriculture's contribution to climate change are both of primary concern.

Nevertheless, of many drought-resistant oil plants, *Jatropha curcas* (as a non-edible oil) avoids the food versus fuel conflict, is free of induced land use change, and requires no additional agricultural land or rainforest, irrigation, or chemicals. In addition, *Jatropha* smallholder family farming concepts are renowned for their respect for gender equality, as well as social and property rights. In particular for developing countries and emerging markets in Africa, Asia, and Latin America, *Jatropha curcas* seems to exhibit the best conditions for producing sustainable biofuels for the power, heat, and transport sectors, while at the same time fighting desertification, climate change, poverty, and forced migration by rehabilitation and replanting of degraded soil.

After having been hyped and receiving substantial investment in the late 2000s, the enthusiasm regarding *Jatropha curcas* and, in general, biofuels dissipated dramatically^{98,99}. More recent research, however, has evaluated the agronomic, environmental, technical, and economic performance and potential of *Jatropha curcas*, providing an improved body of literature including Achten et al.¹⁰⁰, Trabucco et al.¹⁰¹, Kumar et al.¹⁰², Koder et al.¹⁰³, and Lestari¹⁰⁴.

Additionally, work by Achten et al.¹⁰⁰ found that, although greenhouse gas (GHG) emission repayment times vary substantially among *Jatropha* production systems, the preferred option to minimise repayment times across oil feedstock is by using "non-agricultural land with low carbon stocks". Supplementary to a possibly closed CO₂ balance for *Jatropha* fuel production until 2050, low carbon stock dry lands can contribute to global cooling by transferring CO₂ from the atmosphere into a humus layer from roots and biomass remains from *Jatropha* plantations

In order to overcome social and environmental conflicts of interest in biofuel cultivation, feedstock is required to grow exclusively on marginal land. Marginal land is that which is not suited for food production, but capable of hosting biofuel production while minimising land use change-induced upfront GHG emissions. Hot, semi-arid areas are capable of meeting these requirements as drought-resistant plants, such as Jatropha, may be cultivated while food production is rarely if not at all found on these soils.

For remote and off-grid areas, capital-intensive industrial high-tech energy storage and grid regulation technologies are hardly an option. Consequently, for hot, semi-arid areas, a specified study concentrated on the potential of Jatropha oil for electricity production in adapted diesel engines as alternative energy storage and balancing power technology within 100% renewable energy hybrid systems. The starting point of this analysis was hot, semi-arid areas as defined in the Köppen-Geiger classification Kriticos et al. (2012). From here the

global potential Jatropha area was gradually narrowed down by subtracting protected areas and cropland already under cultivation. The geodata-based survey on the global potential for Jatropha cultivation in Africa, Asia, and Latin America results in 6.7 million km² of currently available land.

For yield estimation a dataset from Trabucco et al. (2010), based on samples of 325 Jatropha plantations has been available for the present study and was matched to the potential areas of Jatropha production. The global production potential sums up to 266 million tonnes of Jatropha seeds or 66.5 million tonnes of Jatropha oil (25% oil recovery) each year in hot, semi-arid, off-grid areas in Africa, Latin America, and Asia. The geodata-based global Jatropha crop area study was accompanied by a literature review, evaluating labour demand, labour cost, and average prices per hectare for the investment and operating cost of over 150 Jatropha cultivation sites, in Africa, Asia, and Latin America. Table 5-1 summarises the potential.

Table 5-1: World potential Jatropha seed and oil harvest in 2017.

Jatropha Potential in Africa, Asia, and Latin America in 2017	
World's hot, semi-arid area for Jatropha cultivation	6.7 million km ²
World's Jatropha seed production per year	266.0 million tonnes
World's Jatropha oil production per year (25% oil recovery)	66.5 million tonnes

As of now, the Jatropha business is still in its infancy. Almost all of the evaluated Jatropha projects established from 2005-2008 with large-scale investment have now vacated their plantations. However, in the lead-up to 2050, carbon pricing can become a substantial financing tool. To achieve the ambitious goal of the Paris Agreement, leading economists expect a rise of

carbon price levels from USD 30-50 in 2020 to USD 130-160 per tonne of CO₂ by 2050. For biomass energy with carbon capture and storage (BECCS) in 2050, such as Jatropha cultivation on low carbon stock marginal land in hot, semi-arid areas, a carbon price of close to USD 130 is envisaged. Such a carbon price can provide further economic incentive to engage in the cultivation of Jatropha.

By 2050, Jatropha has the potential to become as successful as other fully developed oil plants such as canola oil, sunflower oil, and palm oil. Due to new toxic and non-toxic Jatropha seed varieties of selected super genotypes and new seed varieties especially for hot, semi-arid land and climate conditions, in 2050 a three times higher Jatropha seed yield can be expected compared to today. These high yield seed materials are expected to

also have a higher oil content of 37%. Taking into account an improved press efficiency of 89%, the efficiency of oil recovery will increase from 25% previously to 33%. This reduces the necessary seed input to produce one kilogram of oil from between four and five to only three kilograms. Table 5-2 summarises the forecast global Jatropha seed and oil yield in 2050.

Table 5-2: World potential Jatropha seed and oil harvest outlook in 2050.

Expected Global Jatropha Seed and Oil Yield per Year in 2050	
World's Jatropha seed production (increase by a factor of 3)	798.0 million tonnes
World's Jatropha oil production (37% oil content, 89% press efficiency)	263.0 million tonnes

The expected global Jatropha oil yield of 263 million tonnes by 2050 does not appear significant when compared to today's annual crude oil demand of 4,420 million tonnes. Taking these figures, global Jatropha oil yield could only supply 6% of global demand for liquid fuel.

When considering demand in 2050, however, these quantities are significant. Assuming zero fossil fuel use, the corresponding demand for renewables-based hydrocarbons will, according to this study, be around 5,890 TWh. In this context, 263 million tonnes of liquid Jatropha fuel providing about 2,700 TWh of dense, storable liquid energy is substantial. Moreover, it has to be noted that a study which analyses the complementary yield of cold and drought-resistant oil plants that grow in degraded, cold, semi-arid areas, like camelina sativa, is still missing.

The assumed biofuel contribution in this study accounts to about 900 TWh, which is equivalent to one third of the available Jatropha resource potential. Since one third of the calculated total Jatropha potential is a relatively low biofuel share it can be realistically transposed into production without approaching sustainable limits or inducing conflicts with food production.

Given that hot, semi-arid areas, have not only low yields, but also weak infrastructure, poor education,

and difficult to access resources and capital, new business models and economic and/or development aid concepts are required. To save costs and energy, unnecessary efforts for transport, export, and process energy are to be eliminated just as unwanted expenses for intermediate trade. This calls for decentralised and regional market concepts. The Jatropha CO₂ recycling concept for fuel, food, feed, and fertilizer is taking place within the new economic category of a decentralised social business.

A social business is described by Yunus and Weber (2009) as a non-loss, non-dividend business which reinvests profits, if realised, in the business itself and is created and designed to address social and ecological problems. A Jatropha biorefinery appears to be such a social business, with the ideal combination of technological, ecological, and socioeconomic solutions for especially remote areas. In order to avoid ownership conflicts, it is indicated to organise oil mills and agricultural seed production in integrated ownership within smallholder Jatropha associations. As a consequence, capital and jobs could stay in rural areas through a regional production and consumption concept within closed cycles for CO₂, energy, mineral substances, work, and capital.

Since 50% of all potential Jatropha production areas are located in Africa, also potential income from job creation would favour the economic growth of African countries. The job potential is presented in detail in Gruber et al.⁶⁰. Van Eijck et al. (2012, 2014) found that up to 0.24 full time jobs in low-skilled agricultural work exist per hectare of Jatropha smallholder farms in typical African semi-arid areas. Lestari et al. (2015) evaluated that in Zimbabwe, Tanzania, and Mali, the potential economic value per hectare from manufacturing rural Jatropha products like oil and press cake fertiliser can generate sufficient income for one person per hectare.

Given there are 326 million hectares of semi-arid areas for potential Jatropha cultivation in Africa, a first guess linear approximation suggests a job potential of 78 million low-skilled jobs in agriculture and 326 million jobs in producing products from Jatropha. This provides a promising economic outlook for a major part of the local population. Particularly in Africa with labour costs of USD 3 per

day, agricultural concepts have the highest potential for job creation and to improve the living conditions of smallholder farmers in a range of ways. Moreover, decentralised social businesses such as Jatropha biorefineries could have a supplemental effect as a business incubator and create multiplier effects that may create job effects in excess of the linear approximation above.

Aside from direct job creation, it can be expected that the supply of electricity, transportation, protein, and fertilizer in currently isolated, off-grid areas gives immediate incentives to build up dynamic markets. Therefore, the Jatropha CO₂ recycling concept for fuel, food, feed, and fertiliser could be a promising instrument and powerful tool to fight poverty, climate change, desertification, and forced migration, particularly in hot, semi-arid regions throughout the world. As such it can not only complement an energy transition to 100% renewables, but also act as a valuable carbon sink in supporting the mitigation of global warming.

6. Policy Recommendations towards a Rapid Transition to 100% Renewable Energy

The global movement supporting 100% renewable energy has been growing rapidly in recent years. Internationally, thousands of cities and more than 50 nations, including Sweden, Denmark, New Zealand, Costa Rica and Iceland have all set the ambitious goal to achieve 100% renewable energy, according to IRENA ¹⁰⁵. Under the Paris Agreement, the global community committed to taking action to limit global warming to well below 2°C above pre-industrial levels, aiming to limit it to 1.5°C. Meeting these targets and a full defossilisation can best be achieved by a rapid transition towards 100% renewable sources.

To ensure a smooth, fast, and cost-effective transition to 100% renewable energy across all sectors, governments need to adopt national legislative acts. Policies must ensure sufficient flow of private investment in renewable energy, storage technologies, sector coupling, and smart energy systems. Public financing is essential and can leverage private funding, but private investment is instrumental to enable competition and a rapid scale-up of renewable energy. The rapid transition toward a global 100% renewable energy system is a clearly defined goal. However, for the world to achieve this goal a variety of policy measures are deemed necessary.

6.1. Public & Government Support

The technology and instruments to achieve a 100% renewable energy system are readily available nearly everywhere. A 100% renewable energy system is the only sustainable option to ensure a safe and prosperous future for all, and it is on all of us to work toward a 100% renewable transition. Without support from the political sphere, a transition it is not possible to meet climate goals

fast enough. Political ambition supported by a growing global movement for 100% renewables is the foundation for a transition to take place. While there is no one-size-fits-all approach to achieving 100% renewable energy on a global scale, there are nevertheless certain general policy approaches that will help achieve this goal:

General Approaches to Policy Making for the Energy Transition

To reach a 100% renewable energy system, the policies set in place must be well defined and include ambitious targets that are supported by stable, long-term, and reliable policies ¹⁰⁵. Those policies must always be adapted to the local conditions on the basis of subsidiarity.

A. Commitment

The political will and ambition to achieve 100% renewable energy is not only necessary to ensure the transition's success but will also send out an important signal for all other actors involved. Policies that lead by example will exert positive influence on citizens, investors, and all other stakeholders ¹⁰⁵.

B. Accuracy

Policies that are precise and well-defined in terms of scope, limitations, and time horizons increase the probability of a policy's success, while

providing transparency and legitimacy, hence minimising the risk of policies to be "greenwashed" or watered down ¹⁰⁵.

C. Stability

Policies designed beyond legislative periods combined with regular monitoring procedures regarding their effectiveness and efficiency will build trust with the public. It is important for citizens and the private sector to have confidence in the political frameworks to continuously move forward and execute the energy transition at all levels of society. For policies to be long-lasting, commitment to 100% renewables needs to be a nonpartisan objective to create public trust and favourable market conditions that build confidence for further investments in boosting the private sector ¹⁰⁵.

D. Subsidiarity

To ensure successful policies in renewables and the general energy transition, subsidiarity has to be one of the guiding principles. Shifting from centralized energy production and decentralized consumption to a more distributed system is necessary. Implementing renewable energy systems, grids, and energy storage on the lowest and most practicable political level possible, will provide an abundance of benefits. Energy security, faster energy transitions in developing countries, and citizen or municipal ownership (“energy community”) will garner increased public support for the energy transition itself ^{105,106}. Further information and more detailed recommendations can be found under “4. Decentralisation of the Energy System”.

E. Communication

Today, some renewables are already the cheapest source of energy in most regions of the world. Due to further technological advancements within the renewable sector, especially the solar PV-sector, sinking costs have increased competitive benefits against fossil fuels. The lower costs of renewable energies need to be publicly highlighted and communicated by politicians and the media alike. A 100% renewable energy system not only has environmental benefits, but also significant financial benefits that can support citizens and community budgets, which can then again be used to accelerate the energy transition across every level ¹⁰⁵.

F. Transparency

Fair and more importantly, transparent, policies, administrative procedures, and political behaviour surrounding the energy transition towards 100% renewables will ensure public understanding and even support for the latter. Additionally, the implementation of early information services across every level of governance including opportunities for citizen participation can nurture further support from society ¹⁰⁵.

Policy makers and political leaders across every level of governance, but more specifically on the local level, will have much to gain from a regional, national and international exchange of ideas and best practices with lessons learned ¹⁰⁷.

G. Adaptation

The transition to a global 100% renewable energy system not only requires a shift in policies, but it must also result in a structural transformation of the current energy system and its inherent and institutionalised processes. Those structures have severe consequences when introducing and implementing new policies for the energy sector. Therefore, the standardisation processes and guidelines for the entire energy system need to be revised and adjusted. This is no small task, and requires a deep and necessary intervention of all relevant institutions, organizations and stakeholders involved. Renewables have to be seen and approached as the new “conventional” sources of energy in every way; from detailed policy implementation and subsidies for renewable energy sources and technology to reforming institutional structures of municipalities, states and international organizations. For a timely and successful energy transition, fossil and nuclear energy sources, have to be seen and treated as old and long overcome.

H. Sector Coupling

To date, commitments and policies for 100% renewable energy have focused almost exclusively on the electricity sector. Widening the scope of the electricity sector to integrate other distributed sectors is necessary. Considerable efforts are still needed to speed up the transformation in other end-use sectors such as heating, cooling, transport, and others. It is crucial for policy makers to partly shift their focus to sector coupling to support the inclusion and connectivity across all sectors affected by the energy transition ¹⁰⁵.

Sector coupling can improve economic efficiency of renewable energy utilisation and enable an effective transition of other distributed demand sectors. There are additional benefits for cross-sectoral energy production and consumption, particularly when integrating high shares of variable renewable energy (VRE). New policy vehicles, such as combined power plant compensation, can even promote sector coupling on the private level and play an essential role in contributing to grid stability of renewables (refer 6.2.1. A). Policies for smart sector coupling serve to both increase the electrification of end-use sectors and, at the same time, shape the demand profile of the newly electrified sectors to be more system-friendly ¹⁰⁵.

I. Education & Information

Research, education, and training on renewable energy and zero-emission technologies across all levels, including schools, universities, and vocational training for professionals in economics, politics, engineering and social sciences, needs be strengthened. Public capacity building in all levels of governance surrounding renewable energy technologies, financing, project development, and regulatory and policy frameworks is crucial to build public and political support ¹⁰⁵.

A number of activities can increase reciprocal learning between actors from practice and research. A range of different methods, instruments and activities, such as hosting demonstrations, pilot projects, idea testing, formations of research alliances and training centres, introducing

continuous research monitoring and evaluation processes, and hosting educational programs can all grow opportunities to expand knowledge. Furthermore, it is important to promote research in engineering and technology assessments, while simultaneously enabling an exchange of know-how across the world. Within the industrial sector, research and development also needs to be strengthened, with a particular emphasis on pilot projects and small-scale applications ¹⁰⁷.

Finally, private capacity building, including vocational training, is needed to develop a qualified local workforce for a renewables and efficiency-based energy system, and will also help compensate for jobs lost in the transition. This major restructuring cannot be achieved by simply swapping workforces and technologies. All jurisdictions will need to develop and strengthen their local capacities and expertise, while taking advantage of local human capital fitting their local contexts. Skills and training must be developed and given in order to support the energy transition with all of its scale and scope. To support this, capacity building projects have to be developed to support both administrative and technical staffs within the public sector, but also through a holistic approach spanning across the private sector's workforce. Proper education and knowledge flows will allow for affected individuals of the transition to be well-prepared and able to work with or create the necessary tools and mechanisms of the new energy system ^{105,107}.

6.2. Clear Legislative Frameworks

Renewable energy technologies are cost-competitive with conventional energy sources in most parts of the world and are increasingly penetrating the conventional energy system. Despite this, current policies and realistic (non-IEA) energy outlooks do not point towards a 100%

renewable energy system, which is not in alignment with the Paris agreement nor leading to “well below 2°C” or even a “1.5°C” pathway. To achieve a 100% renewable energy system of global scale we are in urgent need of new policies ¹⁰⁵.

6.2.1. Rapid & Exponential Growth for Renewables

To accelerate the expansion of renewables, the introduction of Feed-In Tariffs is one instrument that has proven itself. Additional legal instruments can be tax exemptions for renewable energy technologies and production (e.g. thermal solar

modules, biofuels and CO₂ neutral synthetic fuels), the introduction of market incentive programmes for renewable heat and storage, and buyer’s premium for electric cars.

A. Enable Direct Private Investments in Renewable Energy and Zero-Emission Technologies.

There are two popular and most applied mechanisms to enable direct private investments in renewable energy: Feed-In Tariffs (1) and Tenders (2).

(1) Feed-In policies, such as tariffs, guarantee a minimum price per unit of electricity or a premium on-top-of-market price, stimulate decentralised private and public, small-and medium-scale investments ¹⁰⁵. Feed-in tariffs exert a legal obligation on utilities to buy electricity from renewable energy producers at a premium rate. These are typically provided over a guaranteed period of time to insure the installation of renewable energy systems, making them a worthwhile and secure investment for producers. The arising extra costs - in case, renewables are not already price-competitive in the specific country - are shared among all energy users, thereby, if the tariff is applied correctly, reducing it to a barely noticeable level ¹⁰⁷. This provides renewable energy priority access to the grid and increases the supply of renewable energy, which brings down costs and makes renewable energy sources cheaper. With renewable technology, energy sources and installation already outcompeting conventional polluting energy sources, a Feed-In Tariff can accelerate the transition without a loss of cost-effectiveness. More so, it obliges grid operators to purchase electricity from renewable sources and sets the price for renewable electricity for long, fixed periods, which provides the stability and safety for the transition to succeed ¹⁰⁷. As an example, the German Renewable Energy Sources Act (EEG 2000), with a fixed feed-in tariff and privileged grid access, is one of the most well-known and proven successful policy frameworks for renewable energy. The policy played a major role in reducing costs for initially cost-intensive wind, solar PV and other renewable technologies. For the future, it is imperative that an EEG-like law includes a privileged guaranteed feed-in-tariff for full system integration and 100 % renewable energy generation.

(2) With auctions, a government issues a call for tenders to install a certain capacity of renewable energy in line with their renewable energy deployment plans to stimulate utility-scale investments ¹⁰⁵. In recent years, a range of countries have introduced tenders instead of feed-in tariffs. An analysis conducted by the Energy Watch Group has shown that tenders have a high chance of limiting the deployment of renewable energy sources ¹⁰⁸. Furthermore, tenders limit investment to large companies and exclude investment from decentralised actors, such as cooperatives. To avoid these challenges, tendering procedures should only apply for capacities above 40 MW. In cases of projects below 40 MW of capacity, an EEG-like framework with feed-in tariffs should apply. It has been shown that decentralised actors like cooperatives have been able to realise projects up to 40 MW. On projects greater than 40 MW, only utility-scale investors can realise the projects, and therefore auctioning is the preferred option.

Box: Evidence from Germany and India Tendering Curbs the Prospects of Renewable Energy Roll-Out

After Germany introduced tenders for ground-mounted PV in 2014, for Biogas in 2016, and for onshore wind in 2017, there was a drastic decline in investment. For example, for onshore wind the granted tariffs in Germany fell for a short time due to preferential effects and a correspondingly high number of bids, as is depicted in Figure Box-A below. Now a more complete picture shows that this tariff reduction was only a

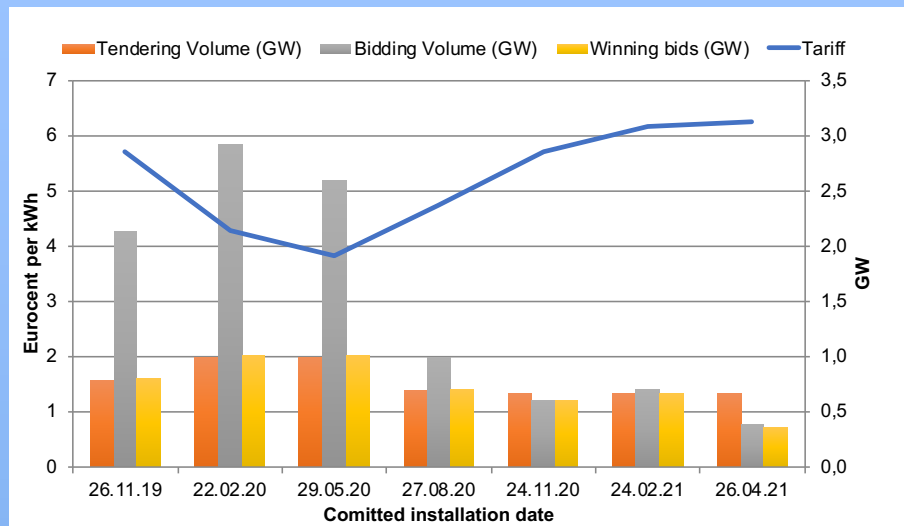

Figure Box-A: Development of the tendering auctions for onshore wind projects from 2017 to 2018 with deadline for commissioning by end of April 2021. Graphic by authors. Data source: [BnetzA] - German Federal Network Agency. 2019. https://www.bundesnetzagentur.de/DE/Sachgebiete/ElektrizitaetundGas/Unternehmen_Institutionen/Ausschreibungen/Win_d_Onshore/BeendeteAusschreibungen/BeendeteAusschreibungen_node.html

once-off effect: First, the bidding volume fell from a hefty 2,137 MW in the first call for tender in 2017 to just 388 MW in the last call in 2018, thereby reaching only 58% of the tendered volume. Second, the tariff rose from the initial 4 euro cents per kWh to more than 6 euro cents per kWh.

Accordingly, Germany is experiencing a dramatic slump in the construction of onshore wind turbines as demonstrated in Figure Box-B below. From an annual expansion of 4.5 GW in 2016, investments fell to 2.4 GW in 2018.

Furthermore, construction permits dropped from several gigawatts to about 1.4 GW in both 2017 and 2018. This suggests that the market will likely not recover in the next few years (Figure Box-B). Thus, the claim that the tenders are an ideal instrument in Germany is also not borne out by the evidence. It is to be expected that the decline will create job losses, further reduce climate protection contributions, and endanger the position of the German wind energy industry.

A similar price increase in auction results has taken place in India, which was once celebrated for having the cheapest prices globally. After achieving record low pricing in February 2018, prices rose by 16% one year later ^{B1,B2,B3}. While the bids were sufficient to reach the targeted volume, the industry is in turmoil. Companies that won bids have often not been able to deliver projects on committed timelines due to factors such as delayed land legislation and they are now facing penalties. On the other hand, the latest auctions might have revealed that previous bids were not economically sustainable even when they are on time. "Developers are realising that there are risks involved in land acquisition and transmission evacuation needs to be priced properly, and that results in higher equity return expectation in the latest [...] bids," according to an expert from Deloitte ^{B4}. Other explanations for increased prices include high concentration of bids from a few large actors, and strategic behaviour such as focussing participation on less windy regions to attain higher prices. Finally, projects are at risk of not being honoured by the government, who frequently rejected results from auctions they deemed to be too highly priced. This adds to the risks of even winning bids ^{B2}.

In summary, the introduction of tenders has not been as efficient as was hoped for by politicians. It does not lead to a sustained decrease in the cost of supported renewable energy. To the contrary, tendering introduces substantial risks such as – among other things – unrecoverable costs of preparing unsuccessful bids, a potential winner's curse with economically unsustainable bids winning support, and opportunistic behaviour of governments that reject winning bids deemed too highly priced. In aggregate, these effects are leading to impaired financing conditions and higher costs. Moreover, the instrument fails concerning the promised accuracy in achieving quantities, since it frequently delivers investment at levels below what is needed. Instead, it risks curbing the domestic renewable energy sectors.

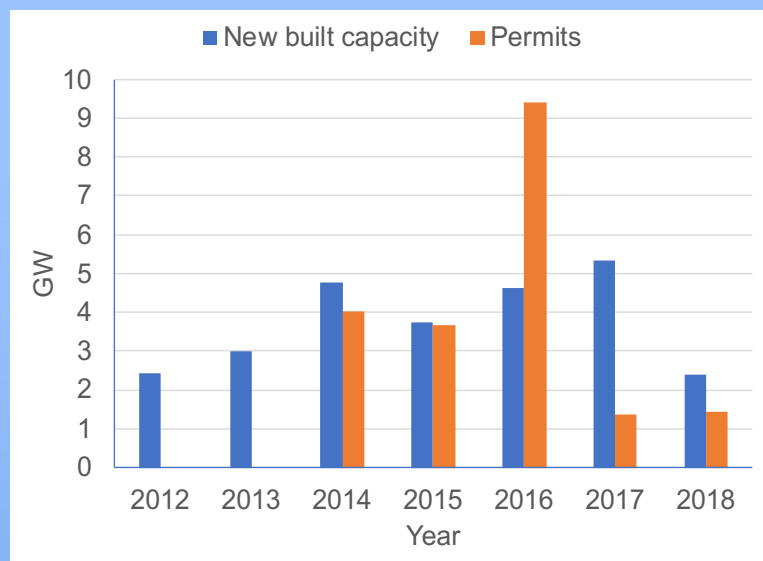

Figure Box-B: Development of newly commissioned onshore wind capacities in Germany before and after the introduction of tendering in 2017. After the preferential effect in 2017, a drastic decline is evident. Graphic by authors. Data source: [BEW] - German Wind Energy Association. 2019. <https://www.wind-energie.de/english/statistics/statistics-germany>

References

- B1 Bloomberg. *Promise of World's Cheapest Wind Power Faces Delays in India*. 2019. <https://www.bloomberg.com/news/articles/2019-02-28/promise-of-world-s-cheapest-wind-power-facing-hurdles-in-india>
- B2 Financial Express. *Price rises in latest India tender, next round launched*. 2019. <https://www.financialexpress.com/industry/wind-power-auction-sees-one-year-high-tariff/1489319/>
- B3 Windpower Monthly. *Price rises in latest India tender, next round launched*. 2019. <https://www.windpowermonthly.com/article/1563045/price-rises-latest-india-tender-next-round-launched>
- B4 Business Standard. *Only 30% of wind capacity commissioned due to unviable bids, policy delay*. 2019. https://www.business-standard.com/article/economy-policy/only-30-of-wind-capacity-commissioned-due-to-unviable-bids-policy-delay-119022800626_1.html

While both are effective in achieving the global renewable energy transition, one has to conclude that Feed-In Tariffs can be more effective than tenders when it comes to policy frameworks. The implementation of feed-in tariffs for compatible and dispatchable renewable energy systems can also be a key incentive scheme to strengthen sector coupling. While many countries and regions have decided to choose tenders, these mechanisms have not led to a rapid, cost-efficient energy transition. We are in need of new and innovative political measures that encourage investments in renewable energy, storage, and grid integration simultaneously without rising energy or electricity costs for consumers.

To transition to a 100% renewable energy system, political regulations should encourage investments across all regions and financial stakeholders. These should encourage investments from both, decentralised actors, such as individuals, homeowners, prosumers, small and medium enterprises, farmers, cooperatives, local utilities, as well as from utility-scaled projects necessary for offshore wind farms. A reformed and adapted version of the EEG, e.g. a hybrid renewable power plant remuneration/combined power plant compensation (Incentive Scheme for 100% Renewable Combined Power Solutions), granting feed-in tariffs for electricity, generated solely by a mix of renewable energy sources, providing hourly, year-round demand coverage - enables just that.

Such combined power plant compensation consists of a remuneration of only e.g. €0.10 per kWh for investments in power plant projects covering the complete energy demand of every client within a self-chosen mix of renewables on a quarter-hourly basis all throughout the year. This instrument would be an essential contribution to the grid stability of renewables, in particular as compensation for fluctuating solar and wind feed-in. Feed-in tariff laws are also possible and necessary for renewable heat in district heating and for renewable gas in gas pipelines.

Feed-In Tariff schemes are not only applicable in industrialised countries. The Uganda Renewable Energy Feed-In Tariff (REFIT) is the perfect example of how to successfully upscale renewables in an underdeveloped country. Today, approximately 90% of Uganda's energy production comes from renewable sources, primarily biomass. The Feed-In Tariff was created by Deutsche Bank and further developed by the German development bank KfW, and the Electricity Regulatory Agency (ERA) of Uganda, with support of the World Bank 108. The combination of transnational know-how and initiative funding by international development institutions is able to transform the energy supply of countries with limited funding possibilities. The Feed-In Tariff is therefore one of the key instruments to start and pursue the energy

transition, and can be applied to every country around the world.

Fixed-price payments, known as FiTs (with fixed or sliding premiums on top of the market price) can be applied in addition to Feed-In Tariffs to advance renewable energy technologies in the energy mix ¹⁰⁵. Other complementary policy measures include: access programs for renewable energy in rural electrification of remote communities, and self-consumption and behind-the-meter-storage to support decentralised and smaller-scale renewables ¹⁰⁵.

To further encourage the expansion of renewables on a global scale, net metering schemes are an effective instrument to encourage the expansion of renewables for private households. This instrument allows consumers who generate some or all of their own electricity to use that electricity anytime, instead of when it is generated.

For the energy transition to 100% renewables to take place as smoothly, rapidly and cost effectively as possible, market rules need to be adapted to reward flexibility and to allow all renewable energy sources to participate in relevant market segments. Only then can every region achieve the optimal renewable energy mix, appropriately fitted to their environment ¹⁰⁵.

B. Tax Exemptions, Direct Subsidies & Legal Privileges

In order for the market share of renewables to increase rapidly and to ensure the most cost efficient transition, renewable energy technologies need to be supported by tax exemptions on property, trade, purchase and more. Particularly in new markets, tax exemptions are crucial to ensure renewable energy market growth and an overall attractive return on investment. An effective and adequate market introduction instrument can be a Renewable Portfolio Standard (RPS), which legally requires (increased) production of renewable energy, be it wind, solar, hydropower, biomass or

geothermal. Renewable Portfolio Standards are needed as one of many policy measures, in places where renewables generally face problems entering the energy market or where fossil or nuclear subsidies are too high for renewables to be competitive and further increase their market share ¹⁰⁵. RPS regulation can be implemented in different ways, supported for example by the most popular instruments of feed-in tariffs and tenders (refer 6.3.1. A. "Instruments enabling direct private investments in renewable energy and other zero-emission technologies").

Tax exemptions, for example VAT exemptions for solar thermal modules purchases, are proven to be effective in encouraging private investments. In the transport sector, mineral oil tax exemptions for biofuels, power-to-gas, and CO₂ neutral synthetic fuels have already been successfully demonstrated and tested. Additionally, zero-emission vehicles could be exempted from the motor vehicle tax. To accelerate a 100% renewable energy transition in the transport sector, policies have to focus on incentivising the production and consumption of bio- or renewable hydrogen fuels, while at the same time developing an alternative energy and

fuel distribution infrastructure and its system integration ¹⁰⁵. Tax exemptions and/or tax incentives for new and existing building energy projects will stimulate efficient zero emission properties and provide additional incentives for private and public investments in zero emission buildings.

In many countries, direct tax subsidies such as market incentive programmes for renewable heat and storage or a buyer's premium for electric cars, have proven to be effective. Such incentive programmes can be implemented on a national or even regional level, wherever applicable.

C. Efficient Energy Consumption

Implementing energy efficiency measures that support a fossil fuel based system does not lead to the level of defossilisation that is necessary to address climate change. To accelerate the energy transition towards 100% renewables, strong attention must be placed on ensuring a clean energy supply, while simultaneously focusing on energy efficiency for end-use consumption. High efficiency buildings, lighting, electric appliances, electronic devices, and other energy loads need to be supported by responsible policies, regulations, mandates, and infrastructure planning. Mandatory efficiency standards as well as building obligations to include renewable technologies in new and/or

retrofitted buildings leads to an increase of renewable energy consumption ¹⁰⁵. These policies should not be limited to the local level. Well defined standards that lead to more energy efficiency have to be implemented on the national, or even on the larger regional level, parallel to recommendations set by multilateral organizations such as UN-bodies. These should be linked to the Sustainable Development Goals (SDG), mainly SDG no. 7, "Affordable and Clean Energy" and SDG no. 11 "Sustainable Cities and Communities". Beyond buildings, efficient transport systems powered by renewable energy sources will reduce energy demand and improve energy efficiency.

D. Promoting Co-Generation Power and Heat

A key element to the world's energy transition is the support for co-generation (particularly bioenergy and power-to-gas) with full heat recovery. This requires good space and construction planning in local and district heating networks, combined with seasonal heat storage (e.g. ice storage depending on the region and application), and integrated solar thermal energy.

Additional support to boost renewable heat supply can be provided by a Feed-In Tariffs and renewable heat supply laws. Construction obligations for buildings to use solar for heat and electricity generation, as in the case of Barcelona and California, have proven to be efficient and successful. In general, co-generation of power and heat should be supported by policy schemes in

order to increase private investments to multilateral governmental financial institutions that can support local private owners, communities and cooperatives.

Domestic solar hot water systems, clean cookers are another way to install co-generation of power and heat on a private level, and to increase heat and energy efficiency. Cooking gas is now available from small-scale biogas producers, removing the need for gas pipelines. For cities and communities with energy intensive industry facilities, an "industrial heating" system can provide many citizens with heat and hot water just by absorbing the residual heat from the industry's production processes ¹⁰⁵.

6.2.2. Phase-Out of Fossil and Nuclear Energy

New laws must reverse tax exemptions and other tax subsidies to the fossil and nuclear energy industry and other energy-intensive industry exemptions must be reversed or cancelled. This would not only save public money, but will also create a level playing field for renewable energy

sources. In addition to the phase-out, the introduction of carbon, methane and radioactivity taxes, further helps internalising the external costs, such as global warming, air pollution, or nuclear waste caused by fossil and nuclear utilities.

A. Removing Subsidies and Pricing Negative Externalities to Level the Playing Field

To accelerate the growth of renewable energy sources, all subsidies and tax exemptions for conventional fossil and nuclear energy plants need to be phased out. This would save public money, which could instead be spent on education, research, or climate change adaptation measures. Particularly in the transport sector, the removal of fossil fuel subsidies is essential for decarbonisation. Without phasing out such state subsidies, it will most likely take too long in certain countries and regions to transform their transport sectors, be it marine, aviation or automobile ¹⁰⁵. Political actors

across the global system have to plan for and the ending of all direct and indirect subsidies to unsustainable energy sources such as fossil and nuclear ¹⁰⁵. Pricing of negative externalities, such as GHG emissions caused by energy production and consumption, and pollution are able to additionally address market distortions favouring conventional energy sources. Pricing negative externalities and ending subsidies for fossil and nuclear will not only further boost the deployment of renewables, but are also indispensable for a successful transition of the global energy system ¹⁰⁵.

B. Introducing carbon, methane and radioactivity tax

Carbon, methane, and radioactivity taxes will sanction energy companies that are producing GHG emissions through fossil fuels and nuclear waste production by nuclear power generation. Such a tax can be effective under the condition that it exceeds the average renewable energy price. While it does not directly promote renewable energy supply as the Renewable Energy Sources Act (refer 6.2.1. A), a tax will reflect the real costs of fossil fuels and nuclear power generation (including hidden environmental, social and economic costs). Carbon, methane and radioactivity taxes can

provide important price signals for reducing such externalities and assist conventional energy generation in becoming further economically unviable over time ¹⁰⁵. Even though such taxes would face challenges in terms of their design and implementation, particularly from the lobbying of energy-intensive industries with strong international competition, a continuously rising carbon and radioactivity tax should replace the emissions trading system, which has proven to be an ineffective policy instrument that is unable to substantially limit carbon emissions over time ¹⁰⁵.

6. 3. Financial Instruments and Building New Institutions

6.3.1. Financing the Transition

For a successful transition to 100% renewable energy by 2050, the required level of investments in renewable energy would be higher than \$67 trillion, but so would be the associated benefits. The annual average investments of \$6 trillion leading up to 2050 are by far outweighed by the

savings of costs of continuing the current system and the savings from reduced air pollution, improved health and mitigated environmental damage resulting in an annual benefit of \$1.7 trillion¹⁰⁵.

A. Investment & Divestment

Scaling-up of both public and private funding is essential to achieve a 100% renewable energy system¹⁰⁵. One way to achieve expanded investment can be through the introduction of public grants and loans that focus on the provision of risk mitigation instruments, which can limit the risks and address some of the barriers faced by private investors. Another option capable of having a similar effect is for investors to co-finance the transition, which would allow for risks to be shared, removing limitations and barriers¹⁰⁵. Example instruments are: public private partnerships (PPP), private financing initiatives (PFI) and civic crowd funding¹⁰⁷.

Simultaneous divestment from fossil fuels and investment in renewable energy projects is important to constantly scale up and ensure

investments from public and private sources. Divestment has also to be undertaken by public and private lenders such as governments, international organizations, private and multilateral financial institutions, and other economic actors and coalitions. These have the potential to unlock significant investments¹⁰⁵. Europe's largest bank, HSBC, shifted away from fossil fuels to renewables, along with others, such as BNP Paribas and ING¹⁰⁹. As of January 2019, more than €8 trillion is committed to be divested from fossil fuels¹¹⁰. "Divestment is hitting the fossil fuel industry where it hurts"¹¹¹, which is forcing fossil and nuclear energy providers to rethink their business models while simultaneously supporting a rapid transition and decreasing stranded assets¹⁰⁵.

B. Introduction of Innovative and Alternative Financing Mechanisms

As described earlier, major investments in technologies and renewable energy infrastructure require consistent and reliable financial support from governments. Aside from the previously mentioned instruments to accelerate private funding, national and regional governments and policy makers should work cohesively with local governments towards decentralised fiscal policies and establish new financing mechanisms and procedures between the different branches of legislation¹⁰⁷. These actions would give individuals and municipalities access to the tax revenues and financial instruments needed to make the necessary local investments, if actions are based on subsidiarity combined with regular monitoring instruments¹¹².

An important factor for new financing mechanisms is their stability and longevity. The consistency of financial support from national, regional and local governments is essential to establish and boost the renewable energy market¹⁰⁷. Only with security, will private investors and individuals opt for renewable energy options over conventional fossil fuels. A Feed-In Tariff can be part of such a stable and long-term support scheme. However, financial support schemes should not only focus on the increased deployment of renewables and renewable technologies, but also set a high priority on energy efficiency and innovative solutions to reduce energy consumption¹⁰⁷.

6.3.2. New & Reformed Institutions as the Backbone of the Transition

Divestments, investments and the set-up of new and innovative financing schemes are elementary to the transition. At the same time, institutions, organizations, and further formal bodies

established to design, implement, and monitor the transition are important stakeholders in achieving a global 100% renewable energy system ¹⁰⁷.

A. Setting Multilateral Institutions to Change the Discourse and Promote Unbiased Transfer of Knowledge

Institutionalised structures need to escalate the energy transition forward on global and local scale by ensuring that there is a transfer of knowledge surrounding climate protection, and more specifically, renewable energy. The global political discourse about the costs and benefits of renewables is only shifting slowly. Interest-based “knowledge” from the fossil energy industry and transport lobby groups still remain dominant in the global discourse ¹¹³. The discourse must be changed and strong, multilateral governmental organizations that are able to make themselves heard on a global scale can play a major role by providing a strong counter narrative based on scientific facts. To guarantee independence from corporate interests, influence, or private investors, such institutions can be set up as an energy agency which – by law – is also independent from short-term political trends and nonpartisan ¹⁰⁷.

IRENA

The most important already existing institution for the energy transition is IRENA; the International Renewable Energy Agency. Since its establishment in 2009, 158 countries and the EU have joined the organization. IRENA was set up and is meant to be the facilitator of the abovementioned knowledge-transfer. Governments can be more actively involved and scale up their funding of the agency

to promote a globally encompassing energy transition to 100% renewables with credible and widely heard actor to ensure the knowledge-transfer of renewable energy ¹¹³.

IRENA as Blueprint for Other Sectors

For a transition towards a global 100% renewable energy system, not only renewable energies have to be institutionally reinforced. IRENA should rather be used as a blueprint for other energy-related sectors, such as transportation. Knowledge-transfer, research coordination, and policy development has to be organised and institutionalised in all related sectors for the transition to be successful. In some sectors, such bodies can be set up as part of already existing institutions, e.g. the FAO, The Food and Agriculture Organizations of the United Nations, could be entrusted with the task of reforming global agricultural structures to organic agriculture with a focus on natural carbon sinks ¹¹³. In other areas, such as the transport sector, the installation of new and independent bodies might prove more effective. Setting up an International Zero Emission Transport Organization (IZETO) would be the most appropriate way to build united capabilities and ensure global knowledge-transfer towards a zero emission transport sector ¹¹³.

B. Strengthening Renewables in Academia

The global conference on renewable energies, Renewables 2004, in Bonn saw the need for an international Open University for Renewable Energies (OPURE). This suggestion was even included in the conference's resulting call for action. The university was outlined to start as a multilateral online platform for scientific and policy exchange in the field of renewable energies. Despite great interest from the scientific community and certain states as well as support from UNESCO, OPURE was not set up¹¹³. It is necessary to revive that idea, based on the plans from 2004 and backed up by a strengthened global community for renewables. Such a university would be an important development. OPURE was planned and should be set up as a global hub for regional, institutional and interdisciplinary cooperation and exchange regarding national and

international strategies and best-practice policy making for renewable energies.

There were and still are proposals to integrate such an institution as part of already existing fossil and nuclear organizations such as the IEA. However, these proposals disregard the fact that the IEA itself has been and still is an active opponent to renewable energies, shown through its constant underestimating of growth rates of renewables in its annual energy forecast analysis World Energy Outlook (WEO)¹¹⁴⁻¹¹⁶. Therefore, placing the renewable agency under the roof of the IEA would provide the latter with a powerful instrument to continue to undermine and slow down the renewable energy transition¹¹³.

C. Establishment of Local but Globally Interconnected Institutions

The setting up of regional or even local tailor-made institutions can act as an organizational cornerstone and support the legal framework around an all-encompassing renewable energy transition, additionally such institutions will be able to bring forward the transition in all dimensions. If built correctly, such institutions can be an access point for citizens to engage as well as provide an investment-friendly climate for large-scale public and financial actors. Such institutions can build up expertise on the local as well as the international level, moreover "a platform for permanent, efficient organisation and allocation of the necessary resources can enable generational continuity of the transformation and coordination of local actors and projects"¹⁰⁷. These bodies will promote and facilitate multi-level governance, encourage cross-sectoral collaboration and foster peer-to-peer cooperation between regions, cities and local governments. The global energy transition is a long-term endeavour and therefore, it needs to be embedded within institutional practices that are formal (e.g. regulations, laws and acts) as well as informal (e.g. round tables, task forces, energy days).

Other than established top-down energy agencies, special energy community authorities (refer 6.4. D) can be added to the institutional spectrum to include a bottom-up perspective, for example to support renewable energy projects on the local and individual levels. Those authorities can be created as part of an international network and integrated into already existing bodies, be it governmental, or an energy agency or international organizations or networks.

To arrive at a global 100% renewable energy system, there is no one-size-fits-all approach. Especially when it comes to regions and countries in need of financial and development assistance, the establishment of special energy community authorities or facilities under the roof of a multilateral financial institution dedicated to finance community energy projects will be able to substantially accelerate the transition in these regions¹⁰⁶. In addition to setting up new institutional bodies, be it external or part of an already existing institution, International Organizations can push the transition as a whole, or in specific projects, such as community energy and increasing investments¹⁰⁶.

6.4. Decentralisation of the Energy System

Urbanisation is one of the most important global trends continuing to shape our societies and therefore our energy systems and structures. We will still be in need of large grids and utility scale investments to feed the energy demand of megacities, those can be gigawatt solar parks or offshore wind energy among others. However, such utility scale investments cause high costs in energy distribution, e.g. for large-scale grid expansions. That being said, this study concludes that 85% of energy demand worldwide can be produced in the same region where it is needed, therefore

decentralisation is the basis for cost-efficient energy systems around the world.

Decentralisation of energy comes with an additional benefit; the empowerment and support of local energy systems by following the principle of subsidiarity can uplift individuals and societies in general. This can happen through participation and community ownership of the energy supply, an increase of local codetermination rights and ultimately a strengthening of civil society and democracy ¹⁰⁷.

Benefits of Community Energy

- Public acceptance and support for renewable energy on the local level
- Added value for the region through the establishment of a new economic sector, job creation and a local identity
- Increase in actor diversity resulting in shared decision-making and increased transparency in planning and construction
- Integration of citizens into sustainable economic processes
- Lower energy prices
- Acceleration of energy access and general renewable deployment rates
- Technology and business model innovation
- Increased resilience to climate change and disasters and increased reliability compared to centralised systems
- Democratisation and decentralisation of energy systems
- Fewer network losses
- Pride of ownership with far-reaching behavioural impacts on all sustainability activities
- Quality service combined with lower energy prices than commercial energy companies

A. Preliminary Assessments

Before planning and thinking about gathering forces and support to implement 100% renewable energy systems, local communities should carry out preliminary assessments to establish their community energy consumption baselines. These will provide a level of understanding of the current state of energy use and will be essential to preparing the data needed for formulating a 100% RE strategy and its specific pathways. Assessing the local renewable energy potential means to quantify the full potential capacity for renewable energy of the specific region ¹⁰⁷. Because the design of a

renewable energy system strongly depends on the natural resources available for a neighbourhood's, community's or municipality's consumption needs. Other than being equipped with the necessary technology for renewable energy production it is important to assess which renewable energy sources or which combination of renewable energy sources – solar (PV and solar thermal), wind, hydro, biomass or geothermal energy – is the most reliable and cost-efficient for each specific region ¹⁰⁷.

B. Programs for Support and Assistance

While subsidiarity is an important cornerstone for a decentralised and successful 100% renewable energy system, it is important for local governments to explore existing options available at different scales (e.g. different levels of government) with the potential to support a

successful 100% renewable transition. These can range from capacity building programs to funding schemes tailored to focus on renewable energy implementation and energy efficiency investments¹⁰⁷.

C. Mobilise Local Resources

It is therefore important that local actors are not left to work in isolation. Local governments play an important role in this regard. From the outset, they must gather and engage interested parties, for which they can use a broad range of instruments. In many places there are already community groups, active and involved in the energy transition, who are eager to participate and support progressive public efforts. Local governments are in the unique position to identify these groups, connect them and get them together with the major regional or municipal stakeholders such as public transport, local utilities and regulators. Creating informal or even formalised meetings, roundtables and working groups could help identify opportunities and barriers of the energy transition and therefore help take advantage of, or overcome them

respectively, in the best, fastest and most inclusive way possible¹⁰⁷. The proposals and results of such discussions and working groups could then become part of even broader coalitions including mayors, residents, and businesses. To gain public acceptance, it is important for local governments to ensure pro-active outreach to people in the community who are not necessarily active in municipal policy matters, including people from low-income communities and structurally disadvantaged groups. Once a local strategy is found, long-term roles and interests can be identified, proposed or “uploaded” to the national or international level, while also evolving through learning from and exchanging with other communities¹⁰⁷.

D. Promotion of Local, Municipal and Community Energy

Once policies are agreed upon and ready to be implemented, local authorities also need to raise capital to support them. This is especially true for urban jurisdictions with little capital available and strong dependence on central governments for financial support. Cooperative funding models and local share-based cooperative models¹¹⁷ combined with open and accessible online tools to monitor public expenditures (e.g. participatory budgeting schemes) are recommended¹¹⁸. In addition to

effective policy-making, planning and implementation, certain legal frameworks already in place are able to support the local and community energy transition. First, the introduction of policies to avoid discrimination against community-based investors in order to create an equal market access for all actors¹⁰⁷. Second, local governments should incentivise decentralised, integrated, community-based renewable energy systems and self-consumption¹⁰⁷.

E. Form and Engage in Local, Regional and International Networks

As mentioned earlier (refer C. Mobilise Resources), exchange and cooperation between the relevant actors is essential, be it at local or regional levels because a complex challenge such as realising a 100% renewable energy system can only be achieved through common efforts. Exchanging experiences and know-how with other local governments and civil society groups will for example enable leapfrogging and might even manifest in a joint wind or solar farm, covering several municipalities¹⁰⁷.

Becoming a part of international networking platforms might not lead to direct results as glaring as a trans-regional wind or solar farm, but such international and global networks support constructive knowledge exchange and cooperation, while similarly enhancing a local government's visibility and branding, if municipalities are ambitious enough and willing to take a lead in the global energy transition. Membership, therefore provides opportunities to promote a city's or community's efforts and emboldens political leaders to partake in common planning processes¹⁰⁷.

7. Abbreviations

A-CAES	Adiabatic compressed air energy storage	LT	Low temperature
BECCS	Bioenergy carbon capture and storage	MDV	Medium duty vehicle
BEV	Battery electric vehicle	MED	Multiple-effect distillation
CAES	Compressed air energy storage	MENA	Middle East and North Africa
CAPEX	Capital expenditures	MSF	Multi-stage flash
CCS	Carbon capture and storage	MT	Medium temperature
CCGT	Combined cycle gas turbine	MW	Megawatt
CHP	Combined heat and power	OCGT	Open cycle gas turbine
CSP	Concentrated solar thermal power	OPEX	Operational expenditures
DAC	CO ₂ Direct air capture	PHEV	Plug-in hybrid electric vehicle
DACCS	Direct air carbon capture and storage	PHES	Pumped hydro energy storage
DH	District heating	PP	Power plant
DME	Dimethyl ether	PtG	Power-to-gas
FCEV	Fuel cell electric vehicle	PtH	Power-to-heat
FLH	Full load hours	PtL	Power-to-liquids
FT	Fischer-Tropsch	PtX	Power-to-X
GHG	Greenhouse gas	PV	Photovoltaics
GT	Gas turbine	p-km	passenger kilometre
GW	Gigawatt	RE	Renewable energy
HDV	Heavy duty vehicle	R/O	Reverse osmosis (seawater)
HHB	Hot heat burner	SAARC	South Asian Association for Regional Cooperation
HT	High temperature	SDG	Sustainable development goals
HVAC	High voltage alternating current	SNG	Synthetic natural gas
HVDC	High voltage direct current	SSA	Sub-Saharan Africa
ICE	Internal combustion engine	ST	Steam turbine
IEA	International Energy Agency	TES	Thermal energy storage
IH	Individual heating	TPED	Total primary energy demand
IPCC	Intergovernmental panel on climate change	TW	Terawatt
LCOC	Levelised cost of curtailment	TTW	Tank-to-wheel
LCOE	Levelised cost of electricity	t-km	tonne kilometre
LCOH	Levelised cost of heat	2W	two wheelers
LCOS	Levelised cost of storage	3W	three wheelers
LCOT	Levelised cost of transmission	€	Euro
LCOW	Levelised cost of water		
LDV	Light duty vehicle		
LNG	Liquefied natural gas		

8. References

1. [IPCC] - International Panel on Climate Change. *IPCC - Special Report on 1.5 Degrees*. Geneva; 2018. <http://www.ipcc.ch/report/sr15/>.
2. United Nations Development Group. *Sustainable Development Goals*. New York; 2015. <http://www.un.org/sustainabledevelopment/sustainable-development-goals/>.
3. REN21. *Renewables 2018: Global Status Report*. Paris; 2018. doi:978-3-9818911-3-3.
4. [IEA-PVPS] - International Energy Agency - Photovoltaics Power Systems. *2018 Snapshot of Global Photovoltaic Markets - IEA PVPS*. St. Ursen; 2018. doi:978-3-906042-58-9.
5. Keiner D, Ram M, Barbosa LSNS, Bogdanov D, Breyer C. *Cost optimal self-consumption of PV Prosumers with stationary batteries, heat pumps, thermal energy storage and electric vehicles across the world up to 2050*. Submitted. 2019.
6. Keiner D, Breyer C. *Modelling of PV Prosumers using a stationary battery, heat pump, thermal energy storage and electric vehicle for optimizing self-consumption ratio and total cost of energy*. In: *33rd European Photovoltaic Solar Energy Conference, Amsterdam 2017, September 25–29 Modelling.*; 2017. <https://goo.gl/cbdASw>.
7. [IEA] - International Energy Agency. *World Energy Outlook 2017*. Paris; 2017. doi:10.1016/0301-4215(73)90024-4.
8. Breyer C, Khalili S, Bogdanov D. *Solar photovoltaic capacity demand for a sustainable transportation sector to fulfil the Paris Agreement by 2050*. *Prog Photovoltaics Res Appl*. 2019; Press. doi:10.1002/pip.3114.
9. BNEF. *Cumulative Global EV Sales Hit 4 Million*. Bloomberg NEF. London; 2018. <https://about.bnef.com/blog/cumulative-global-ev-sales-hit-4-million/>. Accessed February 8, 2019.
10. Wärtsilä. *A Clean Environment - Towards Zero-Emission Shipping*. Vasaa; 2018.
11. [ETC] - Energy Transitions Commission. *Mission Possible: Reaching Net-Zero Carbon Emissions from Harder-to-Abate Sectors by Mid-Century*. London; 2018. <http://www.energy-transitions.org/mission-possible>.
12. Voutchkov N. *Desalination – Past, Present and Future*. London; 2016. <http://www.iwa-network.org/desalination-past-present-future/>.
13. Caldera U, Breyer C. *Potential for the use of 100% renewable energy powered desalination for crop irrigation in the decades to come*. In: *Water Science for Impact Conference, Wageningen, Netherlands*. Wageningen; 2018.
14. Koskinen O, Breyer C. *Energy Storage in Global and Transcontinental Energy Scenarios: A Critical Review*. *Energy Procedia*. 2016; 99: 53-63. doi:10.1016/j.egypro.2016.10.097.
15. Centre for Alternative Technology (CAT). *Raising Ambition - Zero Carbon Scenarios From Across The Globe*. Wales, UK; 2018. www.zerocarbonbritain.org.
16. REN21. *Renewables 2017: Global Status Report*. Paris; 2017. <http://www.ren21.net/gsr-2017/>.
17. Hansen K, Breyer C, Lund H. *Status and Perspectives on 100% Renewable Energy Systems*. Submitted. 2019.
18. Deng YY, Blok K, Van Der Leun K, Petersdorff C. *Transition to a Fully Sustainable Global Energy System*. *Transit to Renew Energy Syst*. 2013; 1(2): 93-118. doi:10.1002/9783527673872.ch7.
19. Pursiheimo E, Holttinen H, Koljonen T. *Inter-sectoral effects of high renewable energy share in global energy system*. *Renew Energy*. 2018; Press: 1-11. doi:10.1016/j.renene.2018.09.082.

20. Löffler K, Hainsch K, Burandt T, Oei P-Y, Kemfert C, von Hirschhausen C, Löffler K, Hainsch K, Burandt T, Oei P-Y, et al. *Designing a Model for the Global Energy System—GENeSYS-MOD: An Application of the Open-Source Energy Modeling System (OSeMOSYS)*. *Energies*. 2017; 10:1468. doi:10.3390/en10101468.
21. Teske S, Pregger T. *Introduction*. In: *Achieving the Paris Climate Agreement Goals*. Sydney: Springer International Publishing; 2019:1-4. doi:10.1007/978-3-030-05843-2_1.
22. Teske S, Sawyer S, Schäfer O. *Energy [R]Evolution: A Sustainable World Energy Outlook 2015*, Greenpeace International. Amsterdam; 2015. <http://www.greenpeace.org/international/Global/international/publications/climate/2015/Energy-Revolution-2015-Full.pdf>.
23. Jacobson MZ, Delucchi MA, Bauer ZAF, Goodman SC, Chapman WE, Cameron MA, Bozonnat C, Chobadi L, Clonts HA, Enevoldsen P, et al. *100% Clean and Renewable Wind, Water, and Sunlight All-Sector Energy Roadmaps for 139 Countries of the World*. *Joule*. 2017; 1: 108-121. doi:10.1016/j.joule.2017.07.005.
24. Sgouridis S, Csala D, Bardi U. *The sower's way: quantifying the narrowing net-energy pathways to a global energy transition*. *Environ Res Lett*. 2016; 11: 094009. doi:10.1088/1748-9326/11/9/094009.
25. Averfalk H, Ingvarsson P, Persson U, Gong M, Werner S. *Large heat pumps in Swedish district heating systems*. *Renew Sustain Energy Rev*. 2017; 79: 1275-1284. doi:10.1016/j.rser.2017.05.135.
26. Blarke M. *Towards an intermittency-friendly energy system: Comparing electric boilers and heat pumps in distributed cogeneration*. *Appl Energy*. 2012; 91: 349-365.
27. Caldera U, Bogdanov D, Breyer C. *Local cost of seawater RO desalination based on solar PV and wind energy: A global estimate*. *Desalination*. 2016; 385: 207-216. doi:10.1016/j.desal.2016.02.004.
28. Tremel A, Wasserscheid P, Baldauf M, Hammer T. *Techno-economic analysis for the synthesis of liquid and gaseous fuels based on hydrogen production via electrolysis*. *Int J Hydrogen Energy*. 2015; 40: 11457-11464. doi:10.1016/j.ijhydene.2015.01.097.
29. Götz M, Lefebvre J, Mörs F, McDaniel Koch A, Graf F, Bajohr S, Reimert R, Kolb T. *Renewable Power-to-Gas: A technological and economic review*. *Renew Energy*. 2016; 85: 1371-1390. doi:10.1016/j.renene.2015.07.066.
30. Fasihi M, Bogdanov D, Breyer C. *Economics of global LNG trading based on hybrid PV-Wind power plants*. In: 31st EU PVSEC. Hamburg. doi:10.4229/31stEUPVSEC2015-7DO.15.6.
31. Varone A, Ferrari M. *Power to liquid and power to gas: An option for the German Energiewende*. *Renew Sustain Energy Rev*. 2015; 45: 207-218. doi:10.1016/j.rser.2015.01.049.
32. [UBA] - Umwelt Bundesamt. *Power-to-Liquids Potentials and Perspectives for the Future Supply of Renewable Aviation Fuel*. Dessau-Roßlau; 2016. http://www.lbst.de/news/2016_docs/161005_uba_hintergrund_ptl_barrierefrei.pdf.
33. Fasihi M, Bogdanov D, Breyer C. *Techno-Economic Assessment of Power-to-Liquids (PtL) Fuels Production and Global Trading Based on Hybrid PV-Wind Power Plants*. *Energy Procedia*. 2016; 99: 243-268. doi:10.1016/j.egypro.2016.10.115.
34. Kranenburg van K, Schols E, Gelevert H, de Kler R, van Delft Y, Weeda M. *Empowering the Chemical Industry – Opportunities for Electrification*. TNO & ECN. Hague & Petten; 2016. www.tno.nl/media/7514/voltachem_electrification_whitepaper_2016.pdf.
35. Palm E, Nilsson LJ, Åhman M. *Electricity-based plastics and their potential demand for electricity and carbon dioxide*. *J Clean Prod*. 2016; 129: 548-555. doi:10.1016/j.jclepro.2016.03.158.
36. [IEA] - International Energy Agency. *Producing Ammonia and Fertilizers: New Opportunities from Renewables*. Paris; 2017. www.iea.org/media/news/2017/FertilizermanufacturingRenewables_1605.pdf.

37. Fasihi M, Breyer C. *Synthetic Methanol and Dimethyl Ether Production based on Hybrid PV-Wind Power Plants*. In: 11th International Renewable Energy Storage Conference (IRES 2017). Düsseldorf, March 14-16; 2017. <http://bit.ly/2qvsLYf>.
38. Garcia-Valle R, Peças Lopes JA, eds. *Electric Vehicle Integration into Modern Power Networks*. New York: Springer; 2013. doi:10.1007/978-1-4614-0134-6.
39. Mahmoudzadeh Andwari A, Pesiridis A, Rajoo S, Martinez-Botas R, Esfahanian V. *A review of Battery Electric Vehicle technology and readiness levels*. *Renew Sustain Energy Rev*. 2017; 78: 414-430. doi:10.1016/j.rser.2017.03.138.
40. Tzannatos E, Papadimitriou S, Koliouisis I. *A Techno-Economic Analysis of Oil vs. Natural Gas Operation for Greek Island Ferries*. *Int J Sustain Transp*. 2015; 9: 272-281. doi:10.1080/15568318.2013.767397.
41. Horvath S, Fasihi M, Breyer C. *Techno-Economic Analysis of a Decarbonized Shipping Sector: Technology Suggestions for a Fleet in 2030 and 2040*. *Energy Convers Manag*. 2018; 164: 230-241. doi:10.1016/j.enconman.2018.02.098.
42. Breyer C, Fasihi M, Aghahosseini A. *Carbon Dioxide Direct Air Capture for effective Climate Change Mitigation based on Renewable Electricity: A new Type of Energy System Sector Coupling, Mitigation and Adaptation Strategies for Global Change*. Press. 2019.
43. Farfan J, Fasihi M, Breyer C. *Trends in the global cement industry and opportunities for a long-term sustainable CCU potential for Power-to-X*. *J Clean Prod*. 2019; 217: 821-835.
44. Breyer C, Bogdanov D, Aghahosseini A, Gulagi A, Child M, Oyewo AS, Farfan J, Sadovskaia K, Vainikka P. *Solar photovoltaics demand for the global energy transition in the power sector*. *Prog Photovoltaics Res Appl*. 2018; 26: 505-523. doi:10.1002/pip.2950.
45. Bogdanov D, Farfan J, Sadovskaia K, Aghahosseini A, Child M, Gulagi A, Oyewo AS, Barbosa LSNS, Breyer C. *Pathway towards sustainable electricity - Radical transformation via evolutionary steps*. *Nat Commun*. 2019; Press.
46. Ram M, Bogdanov D, Aghahosseini A, Oyewo AS, Gulagi A, Child M, Fell H-J, Breyer C. *Global Energy System Based on 100% Renewable Energy - Power Sector*. Study by Lappeenranta University of Technology and Energy Watch Group. Lappeenranta, Berlin; 2017. <https://goo.gl/NjDbck>.
47. [IEA] - International Energy Agency. *World Energy Outlook 2016*. Paris; 2016. http://www.iea.org/publications/freepublications/publication/WEB_WorldEnergyOutlook2015ExecutiveSummaryEnglishFinal.pdf.
48. Toktorova A, Gruber L, Hlusiak M, Bogdanov D, Breyer C. *Long-term load forecasting in high resolution for all countries globally*. Submitted. 2019.
49. Gao L, Yoshikawa S, Iseri Y, Fujimori S, Kanae S. *An economic assessment of the global potential for seawater desalination to 2050*. *Water (Switzerland)*. 2017; 9(10): 763. doi:10.3390/w9100763.
50. Farfan J, Breyer C. *Structural changes of global power generation capacity towards sustainability and the risk of stranded investments supported by a sustainability indicator*. *J Clean Prod*. 2017; 141: 370-384. doi:10.1016/j.jclepro.2016.09.068.
51. Bogdanov D, Breyer C. *North-East Asian Super Grid for 100% renewable energy supply: Optimal mix of energy technologies for electricity, gas and heat supply options*. *Energy Convers Manag*. 2016; 112: 176-190. doi:10.1016/j.enconman.2016.01.019.
52. Afanasyeva S, Bogdanov D, Breyer C. *Relevance of PV with Single-Axis Tracking for Energy Scenarios*. *Sol Energy*. 2018; 173: 173-191.
53. Verzano K. *Climate Change Impacts on Flood Related Hydrological Processes: Further Development and Application of a Global Scale Hydrological Model*. 2009. doi:10.17617/2.993926.

54. Bunzel K, Zeller V, Buchhorn M, Griem F, Thrän D. *Regionale Und Globale Räumliche Verteilung von Biomassepotenzialen*. Leipzig; 2009.
55. Gulagi A, Choudhary P, Bogdanov D, Breyer C. *Electricity system based on 100% renewable energy for India and SAARC*. PLoS One. 2017; 12: 1-27. doi:10.1371/journal.pone.0180611.
56. Ram M, Keiner D, Gulagi A, Breyer C. *Role of Solar PV Prosumers in Enabling the Energy Transition Towards a Fully Renewables Based Power System for India*. In: 1st International Conference on Large-Scale Grid Integration of Renewable Energy in India.; 2017. <https://goo.gl/cbdASw>.
57. Caldera U, Breyer C. *Assessing the potential for renewable energy powered desalination for the global irrigation sector*. Submitted. 2019.
58. Caldera U, Sadiqa A, Gulagi A, Breyer C. *Irrigation efficiency and renewable energy powered desalination as key components of Pakistan's water management strategy*. Forthcoming. 2019.
59. Ram M, Aghahosseini A, Breyer C. *Job creation during the global energy transition towards 100% renewable power system by 2050*. Technol Forecast Soc Change. 2019; Submitted.
60. Gruber G, Dalheimer B. *Sustainable Jatropha Oil as Liquid Energy Storage Option for a World 100% Renewable Energy Supply Study: Resources, Financial and Technical Aspects*. Study by Vereinigte Werkstätten Für Pflanzenöltechnologie (VWP) and University of Göttingen. Allersberg and Göttingen; 2017.
61. Mohamed A. *Youth Unemployment: A Global Security Challenge*. Harvard International Review.; 2014.
62. Kollewe J. *Global Unemployment to Trigger Further Social Unrest, UN Agency Forecasts*. Business. The Guardian.; 2010. <https://www.theguardian.com/business/2010/oct/01/job-market-recession-social-unrest-ilo>
63. [IMF] - International Monetary Fund. *World Economic Outlook (April 2017) - Real GDP Growth*. Washington, D.C.; 2017. <http://www.imf.org/external/datamapper>.
64. Agora Energiewende, Sandbag. *The European Power Sector in 2017. State of Affairs and Review of Current Developments*. Berlin; 2018.
65. [EC] - European Commission. *A Clean Planet for All A European Strategic Long-Term Vision for a Prosperous, Modern, Competitive and Climate Neutral Economy*. Brussels; 2018. https://ec.europa.eu/clima/sites/clima/files/docs/pages/com_2018_733_en.pdf
66. Ram M, Child M, Aghahosseini A, Bogdanov D, Poleva A, Breyer C. *Comparing Electricity Production Costs of Renewables to Fossil and Nuclear Power Plants in G20 Countries*. Prepared by LUT University for Greenpeace. Hamburg; 2017. <http://bit.ly/2u28u0L>.
67. Pal JS, Eltahir EAB. *Future temperature in southwest Asia projected to exceed a threshold for human adaptability*. Nat Clim Chang. 2015; 6: 197-200. doi:10.1038/nclimate2833.
68. Barasa M, Bogdanov D, Oyewo AS, Breyer C. *A cost optimal resolution for Sub-Saharan Africa powered by 100% renewables in 2030*. Renew Sustain Energy Rev. 2018; 92: 440-457.
69. Brookings. *Foresight Africa: Top Priorities for the Continent in 2017*. Washington D.C.; 2017.
70. Gulagi A, Bogdanov D, Breyer C. *The Demand for Storage Technologies in Energy Transition Pathways Towards 100% Renewable Energy for India*. Energy Procedia. 2017; 135: 37-50. doi:10.1016/j.egypro.2017.09.485.
71. Gulagi A, Bogdanov D, Breyer C. *The role of storage technologies in energy transition pathways towards achieving a fully sustainable energy system for India*. J Energy Storage. 2018; 17: 525-539. doi:10.1016/j.est.2017.11.012.
72. Haysom JE, Jafarieh O, Anis H, Hinzer K, Wright D. *Learning curve analysis of concentrated photovoltaic systems*. Prog Photovoltaics Res Appl. 2015; 23(11): 1678-1686. doi:10.1002/pip.2567.

73. Gulagi A, Bogdanov D, Breyer C. *A Cost Optimized Fully Sustainable Power System for Southeast Asia and the Pacific Rim*. *Energies*. 2017; 10(5): 583. doi:10.3390/en10050583.
74. [AEC] - Australian Energy Council. *Solar Report - January 2018*. Melbourne; 2018.
75. Export. *Canada - Power Generation and Renewable Energy*. *Export.Gov*. Washington D.C.; 2018. <https://www.export.gov/article?id=Canada-Power-Generation-and-Renewable-Energy>.
76. Renewable Cities. *Which Canadian Cities Are Moving towards 100% Renewable Energy? - Renewable Cities*. Vancouver; 2018. <https://www.renewablecities.ca/articles/100-per-cent-renewable-energy-and-canadian-cities>.
77. [IRENA] - International Renewable Energy Agency. *Renewable Energy Prospects: Mexico, REmap 2030 Analysis*. Abu Dhabi; 2015. <https://www.irena.org/publications/2015/May/Renewable-Energy-Prospects-Mexico>.
78. Ferreira J. *United States Unemployment Rate 2018*. Trading Economics. <https://tradingeconomics.com/united-states/unemployment-rate>.
79. Breyer C, Heinonen S, Ruotsalainen J. *New consciousness: A societal and energetic vision for rebalancing humankind within the limits of planet Earth*. *Technol Forecast Soc Change*. 2017; 114: 7-15. doi:10.1016/j.techfore.2016.06.029.
80. Mathiesen BV, Lund H, Karlsson K. *100% Renewable energy systems, climate mitigation and economic growth*. *Appl Energy*. 2011; 88(2): 488-501. doi:10.1016/j.apenergy.2010.03.001.
81. [IRENA] - International Renewable Energy Agency and [CEM] - Clean Energy Ministerial. *The Socio-Economic Benefits of Large-Scale Solar and Wind: An EconValue Report*. Abu Dhabi; 2014. https://www.irena.org/-/media/Files/IRENA/Agency/Publication/2016/Socioeconomic_benefits_solar_wind.pdf?la=en&hash=FCFA4C1C1CDA1E2E2B8BE7E71D8BDB55113DE81A.
82. [IRENA] - International Renewable Energy Agency. *Global Energy Transformation: A Roadmap to 2050*. Abu Dhabi; 2018. <https://irena.org/publications/2018/Apr/Global-Energy-Transition-A-Roadmap-to-2050>
83. Creutzig F, Breyer C, Hilaire J, Minx J, Peters G, Socolow R. *The mutual dependence of negative emission technologies and energy systems*. Submitted. 2019.
84. Fasihi M, Efimova O, Breyer C. *Techno-economic assessment of CO2 direct air capture plants*. Submitted. 2019.
85. Child M, Bogdanov D, Breyer C. *The role of storage technologies for the transition to a 100% renewable energy system in Europe*. *Energy Procedia*. 2018; 155: 44-60. doi:10.1016/j.egypro.2018.11.067.
86. Child M, Kemfert C, Bogdanov D, Breyer C. *Flexible electricity generation, grid exchange and storage for the transition to a 100% renewable energy system in Europe*. Submitted. 2019.
87. Breyer C, Bogdanov D, Gulagi A, Aghahosseini A, Barbosa LSNS, Koskinen O, Barasa M, Caldera U, Afanasyeva S, Child M, et al. *On the role of solar photovoltaics in global energy transition scenarios*. *Prog Photovoltaics Res Appl*. 2017; 25(8): 727-745. doi:10.1002/pip.2885.
88. Caldera U, Breyer C. *The role that battery and water storage play in Saudi Arabia's transition to an integrated 100% renewable energy power system*. *J Energy Storage*. 2018; 17: 299-310.
89. Kilickaplan A, Bogdanov D, Peker O, Caldera U, Aghahosseini A, Breyer C. *An energy transition pathway for Turkey to achieve 100% renewable energy powered electricity, desalination and non-energetic industrial gas demand sectors by 2050*. *Sol Energy*. 2017; 158: 218-235. doi:10.1016/j.solener.2017.09.030.
90. Oyewo AS, Aghahosseini A, Bogdanov D, Breyer C. *Pathways to a fully sustainable electricity supply for Nigeria in the mid-term future*. *Energy Convers Manag*. 2018; 178: 44-64.

91. Oyewo AS, Aghahosseini A, Ram M, Breyer C. *Transition towards decarbonised power systems and its socio-economic impacts in West Africa*. Submitted. 2019.
92. Ghorbani N, Aghahosseini A, Breyer C. *Assessment of a power system fully based on renewable energy for Iran by 2050 – Comparison with the current policy scenario*. Submitted. 2019.
93. Sadiqa A, Gulagi A, Breyer C. *Energy transition roadmap towards 100% renewable energy and role of storage technologies for Pakistan by 2050*. *Energy*. 2018; 147: 518-533. doi:10.1016/j.energy.2018.01.027.
94. Gulagi A, Ram M, Solomon AA. *Embedded Risks of Current Energy Policies and Possible Transition Scenarios adopting Renewable Energy: A Case study for Bangladesh*. Submitted. 2019.
95. Oyewo AS, Aghahosseini A, Ram M, Lohrmann A, Breyer C. *Pathways towards achieving 100% renewable energy powered electricity and seawater desalination sectors by 2050 for South Africa*. Submitted. 2019.
96. Otto A, Robinius M, Grube T, Schiebahn S, Praktiknjo A, Stolten D. *Power-to-steel: Reducing CO₂ through the integration of renewable energy and hydrogen into the German steel industry*. *Energies*. 2017;10(4): 451. doi:10.3390/en10040451.
97. Teske S, Meinshausen M, Dooley K. *State of Research*. In: *Achieving the Paris Climate Agreement Goals*. Cham: Springer International Publishing; 2019: 5-23. doi:10.1007/978-3-030-05843-2_2.
98. Achten W, Maes W, Aerts R, Verchot L, Trabucco A, Mathijs E, Singh V, Muys B. *Jatropha: from global hype to local opportunity*. *J Arid Environ*. 2010; 74(1): 164-165.
99. Nielsen F, Raghavan K, de Jongh J, Huffman D. *Jatropha for Local Development, after the Hype*. Hivos, Den Haag, The Netherlands; 2013.
100. Achten WM, Trabucco A, Maes W, Verchot L, Aerts R, Mathijs E, Vantomme P, Singh V, Muys B. *Global greenhouse gas implications of land conversion to biofuel crop cultivation in arid and semi-arid lands. lessons learned from jatropha*. *J Arid Environ*. 2013; 98: 135-145.
101. Trabucco A, Achten WMJ, Bove C, Aerts R, Orshoven J V., Norgrove L, Muys B. *Global mapping of jatropha curcas yield based on response of tness to present and future climate*. *GCB Bioenergy*. 2010; 2(3): 139-151.
102. Kumar P, Srivastava VC, Jha MK. *Jatropha curcas phytotomy and applications: Development as a potential biofuel plant through biotechnological advancements*. *Renew Sustain Energy Rev*. 2016; 59: 818-838.
103. Koder A, Schwanzer P, Zacherl F, Rabl H-P, Mayer W, Gruber, Dotzer. *Combustion and emission characteristics of a 2.2L common-rail diesel engine fueled with jatropha oil, soybean oil, and diesel fuel at various EGR-rate*. *FUEL*. 2018; 228: 23-29.
104. Lestari D, Zvinavashe E, Sanders JP. *Economic valuation of potential products from Jatropha seed in five selected countries: Zimbabwe, Tanzania, Mali, Indonesia, and The Netherlands*. *Biomass and Bioenergy*. 2015; 74: 84-91.
105. IRENA Coalition for Action. *Towards 100% Renewable Energy: Status, Trends and Lessons Learned*. Abu Dhabi; 2019. https://coalition.irena.org/-/media/Files/IRENA/Coalition-for-Action/IRENA_Coalition_100percentRE_2019.pdf.
106. IRENA Coalition for Action. *Community Energy: Broadening the Ownership of Renewables*. Abu Dhabi; 2018. https://coalition.irena.org/-/media/Files/IRENA/Coalition-for-Action/Publication/Coalition-for-Action_Community-Energy_2018.pdf.
107. Global 100% Renewable Energy. *100% RE Building Blocks. A Practical Toolkit for a Sustainable Transition to 100% Renewable Energy*. Bonn; 2017. <http://www.go100re.net/wp-content/uploads/2017/05/100RE-Building-Blocks.pdf>.

108. Fell H-J. *The Shift from Feed-in-Tariffs to Tenders Is Hindering the Transformation of the Global Energy Supply to Renewable Energies*. Berlin; 2017. http://energywatchgroup.org/wp-content/uploads/2018/01/2017-07-15-Policy_Paper_Feed-in_Tariff_Tenders.pdf.
109. Independent. *HSBC Announces It Will Stop Funding New Coal Power Plants and Other Fossil Fuel Industries*. London; 2018. <https://www.independent.co.uk/news/uk/home-news/hsbc-stop-funding-fossil-fuel-industries-paris-agreement-sustainable-energy-a8315891.html>
110. DivestInvest. *Commitments to DivestInvest*. London; 2019. <https://www.divestinvest.org/commitments/>.
111. McKibben B. *At Last, Divestment Is Hitting the Fossil Fuel Industry Where It Hurts*. The Guardian. London; 2018. <https://www.theguardian.com/commentisfree/2018/dec/16/divestment-fossil-fuel-industry-trillions-dollars-investments-carbon>.
112. [UCLG] – United Cities and Local Governments. *UCLG Policy Paper on Local Finance*. Barcelona; 2008. http://www.uclg-localfinance.org/sites/default/files/UCLG_Policy_Paper_on_Local_Finance_-_EN.pdf.
113. Fell H-J. *Global Cooling. Strategies for Climate Protection*. 1st Edition. London; 2012. doi:<https://doi.org/10.1201/b12520>.
114. Metayer M, Breyer C, Fell H-J. *The projections for the future and quality in the past of the World Energy Outlook for solar PV and other renewable energy technologies*. In: 31st EU PVSEC. Hamburg; 2015. doi:10.4229/31stEUPVSEC2015-7DV.4.61.
115. Breyer C, Fell H-J, Zittel W. *IEA Creates Misleading Future Scenarios for Solar Power Generation*. Berlin; 2015. <http://energywatchgroup.org/iea-creates-misleading-future-scenarios-for-solar-power-generation>.
116. Energy Watch Group. *The International Energy Agency Undermines Global Climate Protection and Energy Security in Its Latest World Energy Outlook*. Berlin; 2016. <http://energywatchgroup.org/the-international-energy-agency-undermines-global-climate-protection-and-energy-security-in-its-latest-world-energy-outlook>.
117. [WEC] - World Energy Council. *Perspective Input into the World Energy Council Scenarios: "Innovating Urban Energy"* London; 2016. https://www.worldenergy.org/wp-content/uploads/2016/10/Perspectives_Paper_World-Energy-Scenarios_Innovating-Urban-Energy.pdf.
118. [UNEP] - United Nations Environment Programme Inquiry / [GIB] - Global Infrastructure Basel Foundation. *Sustainable Infrastructure and Finance. How to Contribute to a Sustainable Future*. Inquiry Working Paper 16/09. Geneva; 2016. http://unepinquiry.org/wp-content/uploads/2016/06/Sustainable_Infrastructure_and_Finance.pdf.
119. Khalili S, Rantanen E, Bogdanov D, Breyer C. *Global view on transportation demand development and impact on energy demand and fossil CO2 emissions*. Submitted. 2019.
120. [ETIP-PV] - European Technology and Innovation Platform Photovoltaics. *The True Competitiveness of Solar PV. A European Case Study*. Munich.; 2017. <https://goo.gl/FBzSjx>.
121. Bolinger, Mark; Seel J. *Utility-Scale Solar 2015: An Empirical Analysis of Project Cost, Performance, and Pricing Trends in the United States*. Lawrence Berkeley National Laboratory. Berkley; 2016. <https://emp.lbl.gov/publications/utility-scale-solar-2015-empirical>.
122. Neij L. *Cost development of future technologies for power generation - A study based on experience curves and complementary bottom-up assessments*. Energy Policy. 2008; 36(6): 2200-2211. doi:10.1016/j.enpol.2008.02.029.
123. European Commission. Joint Research Centre. Institute for Energy and Transport., SERTIS. *Energy Technology Reference Indicator (ETRI) Projections for 2010-2050*. Petten.; 2014. <http://publications.jrc.ec.europa.eu/repository/handle/JRC92496>. Accessed October 25, 2017.

124. Sigfússon B, Uihlein A. *2015 JRC Geothermal Energy Status Report*. European Commission - Joint Research Centre. Petten; 2015. doi:10.2790/959587.
125. [IEA] - International Energy Agency. *World Energy Outlook 2015*. Paris; 2015. www.iea.org/publications/freepublications/publication/WEO2015.pdf.
126. McDonald A, Schratzenholzer L. *Learning rates for energy technologies*. Energy Policy. 2001; 29(4): 255-261. doi:10.1016/S0301-4215(00)00122-1.
127. Koomey J, Hultman NE. *A reactor-level analysis of busbar costs for US nuclear plants, 1970-2005*. Energy Policy. 2007; 35(11): 5630-5642. doi:10.1016/j.enpol.2007.06.005.
128. [IEA] - International Energy Agency and [NEA] - Nuclear Energy Agency. *Projected Costs of Generating Electricity*. Paris; 2015. doi:10.1787/cost_electricity-2015-en.
129. Urban W, Lohmann H, Girod K. *Abschlussbericht für das BMBF-Verbundprojekt Biogaseinspeisung*. Fraunhofer UMSICHT. 2009.
130. Kutscher C, Mehos M, Turchi C, Glatzmaier G, Moss T. *Line-Focus Solar Power Plant Cost Reduction Plan*. National Renewable Energy Laboratory (NREL). Vol NREL/TP-55. Golden; 2010.
131. Agora Energiewende. *Stromspeicher in Der Energiewende*. Berlin; 2014. <https://www.agora-energiewende.de/en/topics/-agothem-/Produkt/produkt/61/Stromspeicher+in+der+Energiewende/>.
132. Breyer C, Tsupari E, Tikka V, Vainikka P. *Power-to-gas as an emerging profitable business through creating an integrated value chain*. Energy Procedia. 2015; 73: 182-189. doi:10.1016/j.egypro.2015.07.668.
133. Hoffmann W. *Importance and evidence for cost effective electricity storage*. In: 29th EU PVSEC. Amsterdam, September 22-26; 2014.
134. Svensson R, Odenberger M, Johnsson F, Ströömberg L. *Transportation systems for CO₂-application to carbon capture and storage*. Energy Convers Manag. 2004; 45: 2343-2353.
135. Michalski J, Bungler U, Crotogino F, Donadei S, Schneider G, Pregger T. *Hydrogen generation by electrolysis and storage in salt caverns: Potentials, economics and systems aspects with regard to the German energy transition*. Int J Hydrogen Energy. 2017;42:13427-13443.
136. Caldera U, Bogdanov D, Afanasyeva S, Breyer C. *Role of Seawater Desalination in the Management of an Integrated Water and 100% Renewable Energy Based Power Sector in Saudi Arabia*. Water. 2018; 10(3).
137. Pleßmann G, Erdmann M, Hlusiak M, Breyer C. *Global energy storage demand for a 100% renewable electricity supply*. Energy Procedia. 2014;46:22-31. doi:10.1016/j.egypro.2014.01.154.
138. [BNEF] - Bloomberg New Energy Finance. *New Energy Outlook 2015 - Long-Term Projections of the Global Energy Sector*. London; 2015. doi:10.1017/CBO9781107415324.004.
139. CSIRO Division of Atmospheric Research. *Lifecycle Emissions and Energy Analysis of LNG, Oil and Coal*. Aspendale; 1996.
140. Environmental Protection Agency. *Annexes to the Inventory of U.S. GHG Emissions and Sinks*. Washington, D.C.; 2013.
141. Dii Desert Energy. *2050 Desert Power - perspectives on a Sustainable Power System for EU-MENA*. Munich; 2012.
142. Rutovitz J, Dominish E, Downes J. *Calculating Global Energy Sector Jobs 2015 Methodology Update 2015*. Prepared for Greenpeace International by the Institute for Sustainable Futures, University of Technology Sydney. Sydney; 2015.
143. Solar Power Europe and E&Y. *Solar Photovoltaics Jobs & Value Added in Europe*. Brussels; 2015. http://www.solarpowereurope.org/fileadmin/user_upload/documents/Media/Jobs___Growth.pdf.

144. The Solar Foundation. *Solar + Storage Jobs*. Washington D.C.; 2016.
145. Arcadis. *Preesall Underground Gas Storage*. <https://www.arcadis.com/en/united-kingdom/what-we-do/our-projects/uk/preesall-underground-gas-storage-facility/>.
146. [GDS] - Government Digital Service. *Preesall underground gas storage facility receives planning consent - GOV.UK*. <https://www.gov.uk/government/news/preesall-underground-gas-storage-facility-receives-planning-consent>. Published 2015.
147. Hart D, Sarkissian A. *Deployment of Grid-Scale Batteries in the United States*. By the Schar School of Policy and Government George Mason University for the US DOE. Washington, D.C.; 2016. <http://davidhart.gmu.edu/wp-content/uploads/2016/11/Grid-Scale-Batteries-GMU-case-study-final-9-19-16.pdf>.
148. The Brattle Group for [WIRES] - Working group for Investment in Reliable and Economic electric Systems. *Employment and Economic Benefits of Transmission Infrastructure Investment in the U.S. and Canada*. Cambridge, Massachusetts; 2011.
149. [GTM] - Green Tech Media Research and [ESA] - Energy Storage Association. *U.S. Energy Storage Monitor: 2015 Year in Review Executive Summary*. Boston; 2016.
150. [RFF] - Resources for the Future. *Decommissioning US Power Plants: Decisions, Costs, and Key Issues*. Washington D.C.; 2017.
151. Evonik. *Study for Decommissioning of Kosovo-A Power Plant*. Prepared for European Commission Liaison Office. Essen; 2010. http://eeas.europa.eu/archives/delegations/kosovo/documents/press_corner/decommissioning_study_kosovo_a_power_plant_en.pdf

9. Appendix

Supplementary Data

The Supplementary Data contains the following data pertaining to global as well as the nine major regions.

Final Energy Demand	This contains the final energy demand for the different energy sectors through the energy transition from 2015-2050
Primary Energy Demand	This contains the primary energy demand for the different energy sectors through the energy transition from 2015-2050
Installed Capacity	This contains the cumulative installed capacities of various energy conversion and storage technologies in five-year intervals through the energy transition from 2015-2050
Generation	This contains the output from various energy conversion and storage technologies in five-year intervals through the energy transition from 2015-2050
New Installed Capacity	This contains the new installed capacities of various energy conversion and storage technologies in five-year intervals through the energy transition from 2015-2050
Investments	This contains the new investments in various energy conversion and storage technologies in five-year intervals through the energy transition from 2015-2050
Energy Costs	This contains the LCOE composition of the different energy sectors and presents in more detail the fuel costs in the transport sector in five-year intervals through the energy transition from 2015-2050

The supplementary data can be found in the following link:

http://energywatchgroup.org/wp-content/uploads/2019/04/EWG_LUT_Global100RE_All-Sectors_Global_Data.xlsx

Supplementary Presentations

There are presentations available explaining in sufficient level of detail the findings of this study for the global results and the nine major regions.

Global results

http://energywatchgroup.org/wp-content/uploads/2019/03/EWG_LUT_Global100RE_All-Sectors_global_results_overview.pdf

Europe

http://energywatchgroup.org/wp-content/uploads/2019/03/EWG_LUT_Global100RE_All-Sectors_Europe_results_overview.pdf

Eurasia

http://energywatchgroup.org/wp-content/uploads/2019/03/EWG_LUT_Global100RE_All-Sectors_Eurasia_results_overview.pdf

MENA

http://energywatchgroup.org/wp-content/uploads/2019/03/EWG_LUT_Global100RE_All-Sectors_MENA_results_overview.pdf

Sub-Saharan Africa

http://energywatchgroup.org/wp-content/uploads/2019/03/EWG_LUT_Global100RE_All-Sectors_SSA_results_overview.pdf

SAARC

http://energywatchgroup.org/wp-content/uploads/2019/03/EWG_LUT_Global100RE_All-Sectors_SAARC_results_overview.pdf

Northeast Asia:

http://energywatchgroup.org/wp-content/uploads/2019/03/EWG_LUT_Global100RE_All-Sectors_NEA_results_overview.pdf

Southeast Asia:

http://energywatchgroup.org/wp-content/uploads/2019/03/EWG_LUT_Global100RE_All-Sectors_SEA_results_overview.pdf

North America:

http://energywatchgroup.org/wp-content/uploads/2019/03/EWG_LUT_Global100RE_All-Sectors_NA_results_overview.pdf

South America:

http://energywatchgroup.org/wp-content/uploads/2019/03/EWG_LUT_Global100RE_All-Sectors_SA_results_overview.pdf

A.1. Methodology

The transition modelling was performed with the LUT Energy System Transition Model, which optimises an energy system under certain constraints and this simulation is applied for five-year intervals from 2015 to 2050. A multi-node approach enables the description of any desired configuration of sub-regions and power transmission interconnections. The main constraint for the optimisation is the matching of total power generation and total power demand values for every hour of the applied year and the optimisation criterion is the minimum of the total annual cost of the system. The hourly resolution of the model significantly increases the computation time. However, it guarantees that for every hour of the year the total supply within a sub-region covers the local demand and enables a more precise system description including synergy effects of different system components. The model is based on linear optimisation and performed on an hourly resolution for an entire year (further details on the working of the model along with the respective mathematical representation of the target functions can be found in section 2). The model ensures high precision computation and reliable results. The costs of the entire system are calculated as a sum of the annualised capital expenditures including the weighted average cost of capital, operational expenditures (including ramping costs), fuel costs and cost for GHG emissions for all available technologies.

Power and Heat Sectors

The LUT model simulates an energy system development under specific given conditions as shown in Figure A1. For every time step the model defines a cost optimal energy system structure and operation mode for the given set of constraints: power demand, heat demand for industry, space and domestic water heating, available generation and storage technologies, financial and technical parameters, and limits on installed capacity for all available technologies. The target of the optimisation is the minimisation of total system cost. Costs of the system are calculated as a sum of the annual capital and operational expenditures (including ramping costs) for all available technologies. The transition simulation was performed for the period from 2015 to 2050 in five-year time intervals.

The distributed generation and self-consumption of residential, commercial, and industrial prosumers are included in the energy system analysis and defined with a special model describing the development of the individual power and heat generation capacities. Prosumers can install their own rooftop PV systems, lithium-ion batteries, buy power from the grid, or sell surplus electricity in order to fulfil their demand. At the same time prosumers can install individual heaters for space and water heating. The target function for prosumers is minimisation of the cost of consumed electricity and heat, calculated as a sum of self-generation equipment annual costs, costs of fuels, and costs of electricity consumed from the grid. The share of consumers that is expected to be interested in self-generation gradually increases from 3% in 2015 to an in-built limit of 20% by 2050.

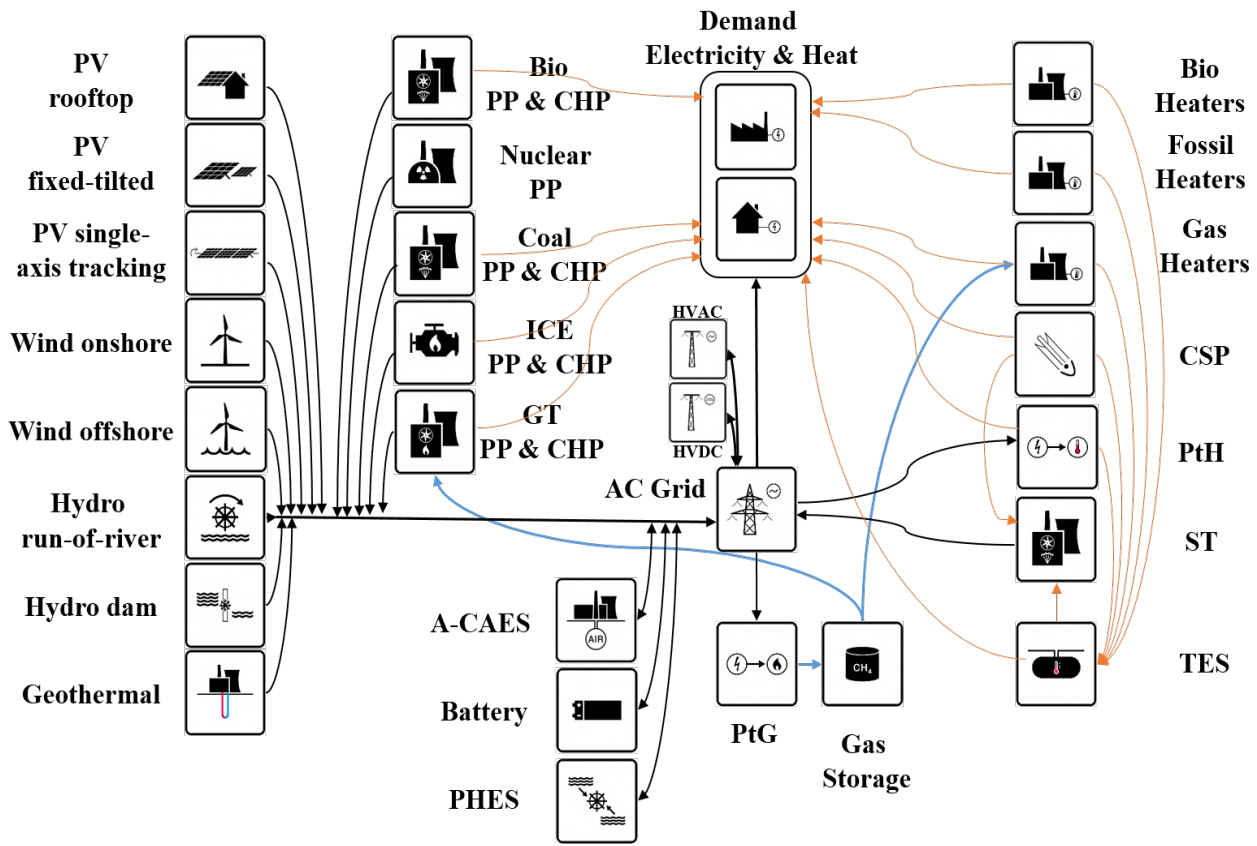

Figure A1: Schematic of the LUT Energy System Transition model comprised of energy converters for power and heat, storage technologies, transmission options, and demand sectors.

The model has integrated all crucial aspects of an energy system. Technologies introduced to the model can be classified into five main categories:

- Electricity generation: fossil, nuclear, and RE technologies
- Heat generation: fossil and RE technologies
- Energy storage
- Energy sector bridging
- Electricity transmission

Fossil electricity generation technologies are coal power plants, combined heat and power (CHP), oil-based internal combustion engine (ICE) and CHP, open cycle (OCGT) and combined cycle gas turbines (CCGT), and gas-based CHP. RE electricity generation technologies are solar PV (optimally fixed-tilted, single-axis north-south tracking, and rooftop), wind turbines, hydropower (run-of-river and reservoir), geothermal, and bio energy (solid biomass, biogas, waste-to-energy power plants, and CHP). Fossil heat generation technologies are coal-based district heating, oil-based district and individual scale boilers, and gas-based district and individual scale boilers. RE-based heat generation technologies are concentrated solar thermal power (CSP) parabolic fields, individual solar thermal water heaters, geothermal district heaters, and bioenergy (solid biomass, biogas district heat, and individual boilers).

Storage technologies can be divided into three main categories: short-term storage – lithium-ion batteries and pumped hydro energy storage (PHEs); medium-term storage – adiabatic compressed air energy storage (A-CAES), and high and medium temperature thermal energy storage (TES) technologies; and long-term gas storage including power-to-gas (PtG) technology, which allows the production of synthetic methane to be utilised in the system.

Bridging technologies are power-to-gas, steam turbines, electrical heaters, district and individual scale heat pumps, and direct electrical heaters. These technologies convert energy from one sector into valuable products for another sector in order to increase total system flexibility, efficiency, and decrease overall costs. A detailed overview can be found in Bogdanov et al ⁴⁵.

Transport Sector

Transportation demand is derived for the modes: road, rail, marine, and aviation for passenger and freight transportation. The road segment is subdivided into passenger LDV, passenger 2W/3W, passenger bus, freight MDV, and freight HDV. The other transportation modes are comprised of demand for freight and passengers. The demand is estimated in passenger kilometres (p-km) for passenger transportation and in (metric) ton kilometres (t-km) for freight transportation. Further information and data for transportation demand along with fuel shares and specific energy demand are provided in Breyer et al. ⁸.

The transportation demand is converted into energy demand by assuming an energy transition from current fuels to fully sustainable fuels by 2050, whereas the following principal fuel types are taken into account and visualised in Figure A2:

- Road: electricity, hydrogen, liquid fuels
- Rail: electricity, liquid fuels
- Marine: electricity, hydrogen, methane, liquid fuels
- Aviation: electricity, hydrogen, liquid fuels

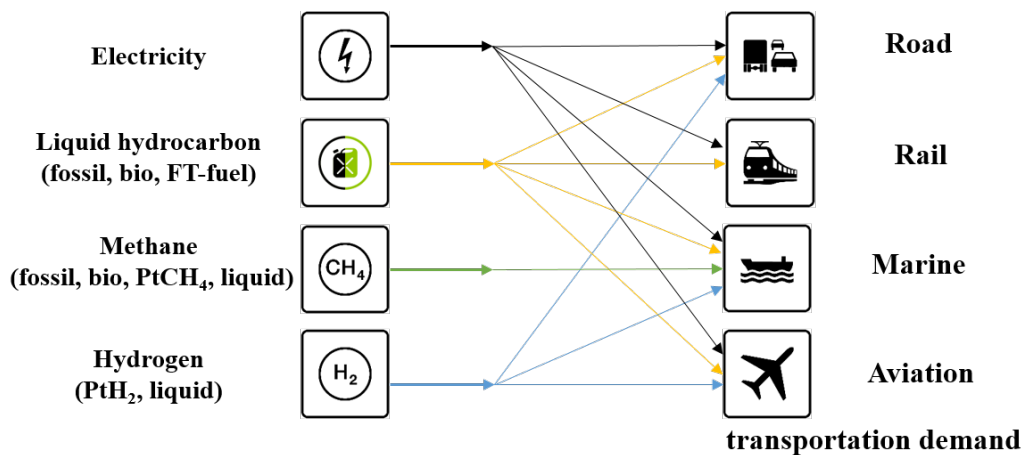

Figure A2: Schematic of the transport modes and corresponding fuels utilised during the energy transition from 2015-2050.

Industry Sector

The model includes the industry sector, which comprises of industrial fuel production, desalination and CO₂ removal. The inclusion of further industry sector, such as Cement, Iron & Steel, Chemicals, Metal refining (in particular Aluminium), Pulp & Paper, and remaining sectors is planned for the future.

Industrial Fuels Production

The energy system can take fossil fuels, as long as it is allowed or affordable, and it can convert biomass to biofuels and produce renewable electricity based synthetic fuels to use all fuels in the sectors Power, Heat or Transport.

Currently hydrogen, methane and liquid hydrocarbons production units are integrated in the model.

Methane can be produced from biogas after its purification/ upgrading, then this biomethane can be used in the gas system, the share of biogas, which can be upgraded is limited by the urbanisation level of the region, but cannot exceed 70% even if the urbanisation level is higher. Second option is synthetic natural gas (SNG) – methane produced with methanation reactors from hydrogen and carbon dioxide. The whole Power-to-Gas (PtG) system includes water electrolysis reactors (assumptions are based on alkaline technology), producing hydrogen from water, CO₂ direct air capturing (DAC) units, collecting CO₂ and water from ambient air, and methanation units. Water electrolyzers and DAC units consume power from the system in order to produce H₂ and CO₂, methanation units converts it to synthetic CH₄.

Liquid hydrocarbons can be produced from biomass by biorefineries, or can be synthesized from H₂ and CO₂ using the Fischer-Tropsch process. PtG with gas storage and gas turbines can be part of storage for the Power sector.

Fossil fuel refineries are not included in the model and existing capacities of refineries are assumed sufficient to satisfy local consumption of fossil fuels.

The fuel conversion process adopted to produce sustainable fuels is shown in Figure A3.

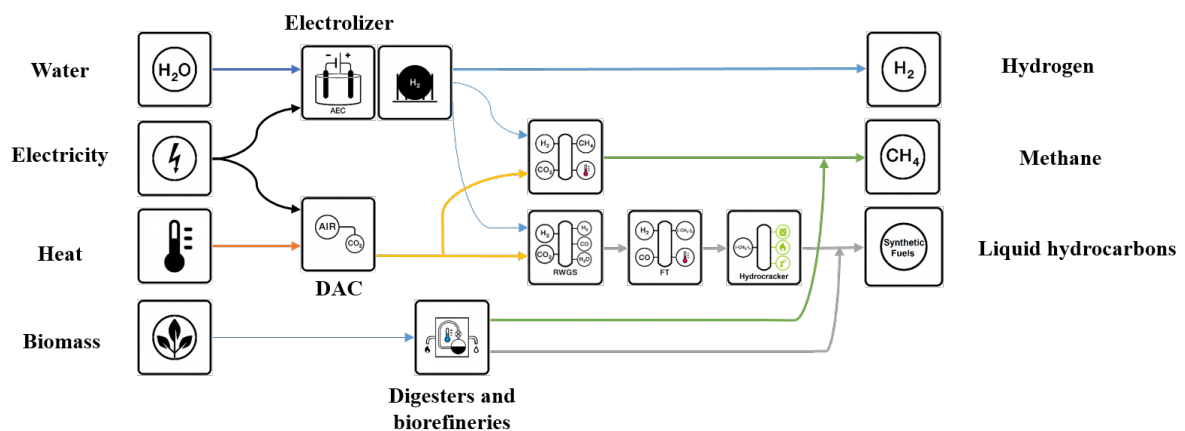

Figure A3: Schematic of the value chain elements in the production of sustainable fuels.

The fuel shares of the transportation modes in the road segment are based directly or indirectly on levelised cost of mobility (LCOM) considerations for newly sold vehicles, which change the stock of vehicles according to the lifetime composition of the existing stock. Vehicle stock and overall demand data are then linked to specific energy demand values to calculate demand of fuels and electricity for the transport sector. A more detailed description of the methodology is provided in Breyer et al. ⁸.

Desalination Sector

The LUT Energy System Transition model is used to identify the lowest cost configuration of 100% RE hybrid power plants to enable a low water production cost. The levelised cost of water includes the water production cost as well as the pumping of water from the coastline to the sites with desalination demand. An hourly simulation is performed as part of the LUT Energy System Transition model as indicated in Figure A4.

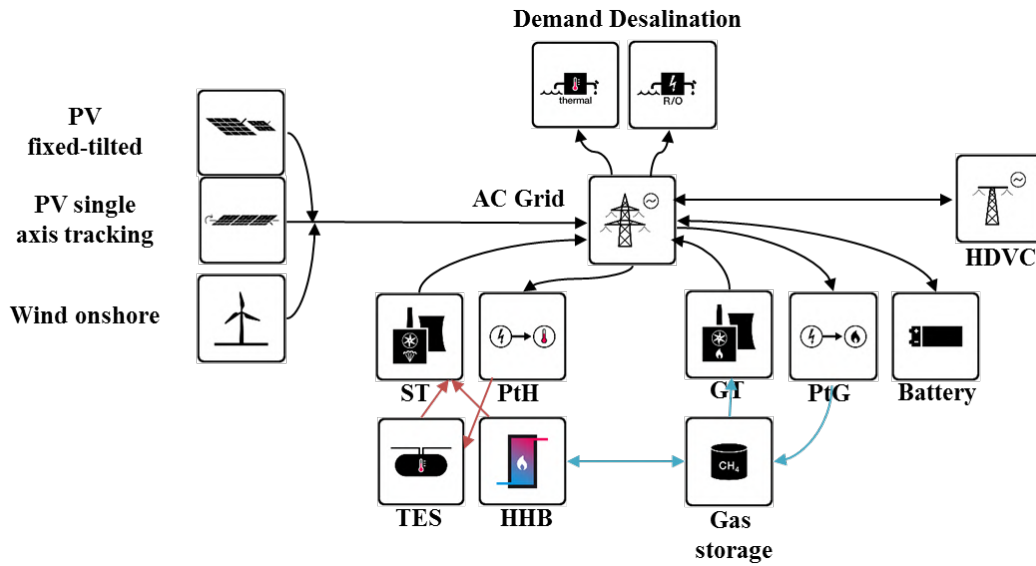

Figure A4: Schematic of the LUT Energy System Transition model to determine the optimal combination of components that meet the hourly electricity demand of SWRO desalination capacities.

The desalination demand is estimated for regions with water stress greater than 40% and is a function of the water stress and total water demand for a specific year. The water stress we refer to is explained in more detail in Caldera et al. ²⁷. The total water demand is the sum of the projected demand from the municipal, industrial and agricultural sectors. Irrigated agriculture accounts for 70% of the global water withdrawals. However, the average global irrigation efficiency is estimated to be as low as 33% and experience a maximum relative growth rate of 0.3% per annum. In Caldera et al. ⁵⁷, a scenario is presented where the irrigation efficiencies are increased using a maximum relative growth rate of 1% per annum. The irrigation efficiency growth rate per annum varies with water stress, based on a logistic expression. It is assumed that irrigation sites with water stress higher than 80% have a maximum growth rate of 1% per annum. The improved irrigation efficiency results in reduction in water demand, water stress and consequently desalination demand for a given year. This methodology, the data and assumptions used, to project the desalination demand from 2015 to 2050, are discussed in Caldera and Breyer ^{57,58}. Therefore, the desalination demand presented in the report addresses the demands of the municipal, industrial and agricultural sector with improved irrigation efficiency.

CO₂ Removal Sector

CO₂ removal demand can be specified for each regions in tones of CO₂ per year. This amount of CO₂ will be captured from atmosphere by DAC units in addition to CO₂ captured for the synthetic fuels production. Heat and electricity needed for the DAC operation will be taken from Heat and Power sectors respectively. The simplified structure of the CO₂ removal sector is presented in Figure A5. A more detailed description of the methodology, data, and assumptions can be found in Breyer et al. ⁴².

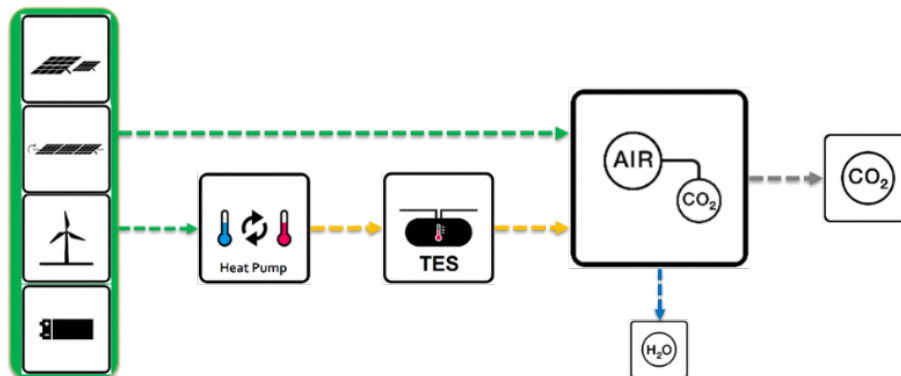

Figure A5: CO₂ removal sector structure

Integrated System

Each sector can be modelled individually or as a whole by coupling power, heat, transport and desalination sectors. The sectors power and heat are preferred to be modelled in a sector coupling way, since CHP plants and PtH technologies, such as heat pumps, couple both sectors very closely. Technologies such as PtG, electrical heating (heating rod, heat pumps), steam turbines, SWRO desalination, FT-fuel production can operate as 'bridging technologies' binding different sectors. Flexible power demand from Heat, Transportation, Industrial fuel production, Desalination and CO₂ removal sectors together with better energy management due to bridging technologies can lead to significant increase in the integrated system efficiency and drop of the total system cost.

A.2. Model Description

The energy system optimisation model is based on a linear optimisation of the system parameters under a set of applied constraints with the assumption of a perfect foresight of RE power generation and power demand. A multi-node approach enables the description of any desired configuration of sub-regions and power transmission interconnections. The main constraints for the optimisation is the matching of all types of generation and demand values for every hour of the applied year and the optimisation criteria is minimum of the total annual cost of the integrated system (or a sector if only a sector is optimised). The hourly resolution of the model significantly increases the required computation time, however it guarantees that for every hour of the year the total supply within a sub-region covers the local demand and enables a more precise system description including synergy effects of different system components or sectors (sector coupling). The optimisation is performed in a third-party solver. Currently, the main option is MOSEK ver. 8, but other solvers (Gurobi, CPLEX, etc.) can also be used. The model is compiled in the Matlab environment in the LP file format, so that the model can be read by most of the available solvers. After the simulation, results are parsed back to the Matlab data structure and post-processed.

Target Function

The target of the system optimisation is the minimisation of the total annual cost of the integrated system (or a sector if only a sector is optimized), calculated as the sum of the annual costs of installed capacities of the different technologies, costs of energy and products generation and production ramping. This target function includes annual costs of the Power, Heat, Transportation, Industrial (Industrial fuels production, Desalination and CO₂ removal) sectors. The target function of the applied energy model for minimising annual costs is presented in Eq. (1) and comprises all hours of a year using the abbreviations: sub-regions (r , reg), generation, storage and transmission technologies (t , $tech$), capital expenditures for technology t ($CAPEX_t$), capital recovery factor for technology t (crf_t), fixed operational expenditures for technology t ($OPEXfix_t$), variable operational expenditures technology t ($OPEXvar_t$), installed capacity in the region r of technology t ($instCap_{t,r}$), annual generation by technology t in region r ($E_{gen,t,r}$), cost of ramping of technology t ($rampCost_t$) and sum of power ramping values during the year for the technology t in the region r ($totRamp_{t,r}$).

$$\min \left(\sum_{r=1}^{reg} \sum_{t=1}^{tech} (CAPEX_t \cdot crf_t + OPEXfix_t) \cdot instCap_{t,r} + OPEXvar_t \cdot E_{gen,t,r} + rampCost_t \cdot totRamp_{t,r} \right) \quad (1)$$

The power prosumers and individual heating users system is realised in an independent sub-model with a slightly different target function. The prosumers system is optimized for each sub-region independently, even if the sub-region is connected to neighbors inside the area. The target function includes annual costs of the prosumers power generation and storage, and heating equipment, the cost of electricity required from the distribution grid and the cost of fuels required for boilers, income of electricity feed-in to the distribution grid is deducted from the total annual cost.

The target function of the applied energy model for minimising annual costs is presented in Eq. (2) and comprises all hours of a year using the abbreviations: generation and storage technologies (t , $tech$), capital expenditures for technology t ($CAPEX_t$), capital recovery factor for technology t (crf_t), fixed operational expenditures for technology t ($OPEXfix_t$), variable operational expenditures technology t ($OPEXvar_t$), installed capacity of technology t ($instCap_t$), annual generation by technology t ($E_{gen,t}$), retail price of electricity ($elCost$), feed-in price of electricity ($elFeedIn$), annual amount of electricity required from the grid (E_{grid}), annual amount of electricity fed-in to the grid (E_{curt}).

$$\min \left(\sum_{t=1}^{tech} (CAPEX_t \cdot crf_t + OPEXfix_t) \cdot instCap_t + OPEXvar_t \cdot E_{gen,t} + elCost \cdot E_{grid} + elFeedIn \cdot E_{curt} \right) \quad (2)$$

Energy Balance Constraints

The main constraint for the Power sector optimisation is the matching of the power generation and demand for every hour of the applied year as shown in Eq. (3), for every hour of the year the total generation within a sub-region and electricity import covers the local electricity demand.

$$\forall h \in [1,8760] \sum_t^{tech} E_{gen,t} + \sum_r^{reg} E_{imp,r} + \sum_t^{stor} E_{stor,disch} = E_{demand} + \sum_r^{reg} E_{exp,r} + \sum_t^{stor} E_{stor,ch} + E_{curt} + E_{other} \quad (3)$$

Eq. (3) describes constraints for the energy flows of a sub-region. Abbreviations: hours (h), technology (t), all modelled power generation technologies ($tech$), sub-region (r), all sub-regions (reg), electricity generation (E_{gen}), electricity import (E_{imp}), storage technologies ($stor$), electricity from discharging storage ($E_{stor,disch}$), electricity demand (E_{demand}), electricity exported (E_{exp}), electricity for charging storage ($E_{stor,ch}$), electricity consumed by other sectors (Heat, Transport, Desalination, Industrial fuels production, CO₂ removal) (E_{other}), curtailed excess energy (E_{curt}). The energy loss in the high voltage direct current (HVDC) and alternating current (HVAC) transmission grids and energy storage technologies are considered in storage discharge and grid import value calculations.

The Heat sector energy balance is defined by 3 equations: for industrial high temperature heat demand, for industrial high and medium temperature heat demand, all centralised heat demand: all industrial demand (high, medium and low temperature heat) and centralized space and water heating demand. High temperature heat can be only generated by fuel-based boilers Eq. (4). Medium temperature heat can be also generated by electrical heating and can be stored in high temperature heat storage and used to produce electricity with steam turbines Eq. (5). Low temperature heat can be also provided by heat pumps, electric heating rods and waste heat from other technologies Eq. (6).

$$\forall h \in [1,8760] \sum_t^{techHH} E_{gen,t} = E_{demandHH} \quad (4)$$

$$\forall h \in [1,8760] \sum_t^{techHH} E_{gen,t} + \sum_t^{techMH} E_{gen,t} + E_{stor,disch} = E_{demandHH} + E_{demandMH} + E_{stor,ch} + E_{other} \quad (5)$$

$$\forall h \in [1,8760] \sum_t^{tech} E_{gen,t} + \sum_t^{stor} E_{stor,disch} = E_{demand} + \sum_t^{stor} E_{stor,ch} + E_{curt} + E_{other} \quad (6)$$

Abbreviations: hours (h), technology (t), high temperature heat generation technologies ($techHH$), medium temperature heat generation technologies ($techMH$), all heat generation technologies ($tech$), industrial high temperature heat demand ($E_{demandHH}$), industrial medium temperature heat demand ($E_{demandMH}$), total centralized heat demand, including industrial, and space heating and water heating demand (E_{demand}).

Power and Heat sector constraints for prosumers have some minor differences. Prosumers can buy electricity from the electricity distribution companies (Eq. 7). Heating of prosumers based on individual heaters includes fuel, RE and electricity based heaters, but there is no individual heat storage option (Eq. 8).

$$\begin{aligned} \forall h \in [1,8760] \quad & \sum_t^{tech} E_{gen,t} + \sum_t^{stor} E_{stor,disch} \\ & = E_{demand} - E_{grid} + \sum_t^{stor} E_{stor,ch} + E_{curt} + E_{other} \end{aligned} \quad (7)$$

$$\forall h \in [1,8760] \quad \sum_t^{tech} E_{gen,t} = E_{demand} + E_{curt} \quad (8)$$

Abbreviations: hours (h), technology (t), all modelled power generation technologies ($tech$), energy generated (E_{gen}), storage technologies ($stor$), energy from discharging storage ($E_{stor,disch}$), energy demand (E_{demand}), electricity energy for charging storage ($E_{stor,ch}$), electricity consumed by heating (E_{other}), excess energy (E_{curt}).

Power and Heat Generation

The renewables based power and heat generation is defined by historical capacity factors for this technology and the optimal installed capacity for this technology Eq. (9).

$$\forall h \in [1,8760] \quad E_{genRE,h} = CF_{genRE,h} \cdot instCap_{genRE} \quad (9)$$

Abbreviations: hour (h), renewables based generation technology ($genRE$), energy generated by renewables based generation technology (E_{genRE}), capacity factor of the technology (CF_{genRE}), installed capacity in the region of the technology ($instCap_{genRE}$).

The fuel-based power and heat generation defined by the optimal installed capacity for this technology Eq. (10), availability factor for this technology Eq. (11), this technology used fuel available Eq. (12), and efficiency of the technology Eq. (13).

$$\forall h \in [1,8760] \quad E_{genFU,h} \leq instCap_{genFU} \quad (10)$$

$$\sum_h^{8760} E_{genFU,h} \leq 8760 \cdot AF_{genFU,h} \cdot instCap_{genFU} \quad (11)$$

$$\sum_h^{8760} FU_{genFU,h} \leq totalFU_{genFU} \quad (12)$$

$$\forall h \in [1,8760] \quad E_{genFU,h} = FU_{genFU,h} \cdot eff_{genFU} \quad (13)$$

Abbreviations: hour (h), fuel based generation technology ($genFU$), energy generated by fuel based generation technology (E_{genFU}), installed capacity in the region of the technology ($instCap_{genFU}$), availability factor of the technology (AF_{genFU}), fuel consumption for the hour h ($FU_{genFU,h}$), annual fuel consumption for the hour h ($totalFU_{genFU,h}$), energy conversion efficiency for technology (eff_{genFU}).

For all technologies, capacity is calculated in output units, for cogeneration the capacity is given in electrical units.

For some types of fuel: Municipal wastes, Industrial biomass wastes, Biogas – all available fuel must be consumed for sustainability reasons. Biogas inflow in the system is constant and biogas can be stored only for 48 hours.

Power and Heat Storage

Storage technologies are described with energy storage capacity and storage interface capacity. Energy storage capacity limits the maximum state of charge (SoC) of the storage, the amount of energy stored Eq. (14), while the storage interface capacity limits the maximum power of charge and discharge Eq. (15), (16). Energy balance constraint for storage technologies is given in Eq. (17).

$$\forall h \in [1,8760] SoC_{stor,h} \leq instCapEn_{stor} \quad (14)$$

$$\forall h \in [1,8760] E_{stor,ch,h} \leq instCapInt_{stor} \quad (15)$$

$$\forall h \in [1,8760] E_{stor,disch,h} \leq instCapInt_{stor} \quad (16)$$

$$\begin{aligned} \forall h \in [1,8760] SoC_{stor,h} &= SoC_{stor,h-1} \cdot selfDisch_{stor} + E_{stor,ch,h} \cdot eff_{stor,ch} \\ &- E_{stor,disch,h} / eff_{stor,disch} \end{aligned} \quad (17)$$

Abbreviations: hour (h), storage technology ($stor$), storage state of charge for an hour h ($SoC_{stor,h}$), installed energy capacity of the storage ($instCapEn_{stor}$), installed power capacity of the storage ($instCapInt_{stor}$), charging energy of the storage for an hour h ($E_{stor,ch,h}$), discharging energy of the storage for an hour h ($E_{stor,disch,h}$), hourly self discharge of the storage ($selfDisch_{stor}$), charge efficiency ($eff_{stor,ch}$), discharge efficiency ($eff_{stor,disch}$).

Power Transmission

Power transmission is presented by HVDC and HVAC grids. Each line of the grid is represented in the model as 2 unidirectional lines: import and export line, capacity of each line is equal to the total capacity of the line, as shown in Eq. (18). Hourly export/import energy for a sub-region is calculated as sum of all import lines multiplied by this line transmission efficiency minus sum of all export line energy flows, as shown in Eq. (19). The efficiency of energy transmission with HVDC lines depends on the distance and AC/DC converters pair efficiency, as shown in Eq. (20), efficiency of energy transmission with HVAC line depends only on distance, as shown in Eq. (21). For both HVDC and HVAC the distance related losses are calculated in a simplified way.

$$\forall h \in [1,8760] \text{ line}_{import,h} \leq instCap_{line} ; \text{ line}_{export,h} \leq instCap_{line} \quad (18)$$

$$\forall h \in [1,8760] E_{exp/imp,h} = \sum_l^{lines} \text{ line}_{import,l,h} \cdot eff_l - \sum_l^{lines} \text{ line}_{export,l,h} \quad (19)$$

$$eff_l = eff_{CS} \cdot (1 - distance \cdot EffLoss) \quad (20)$$

$$eff_l = 1 - distance \cdot EffLoss \quad (21)$$

Abbreviations: hour (h), line (l), energy flow through the power line ($line$), installed capacity of the power line ($instCap_{line}$), exported/imported energy for the region for an hour h ($E_{exp/imp,h}$), total energy import efficiency (eff), converter pair efficiency (eff_{CS}), charge length of the line ($distance$), energy loss in the line ($EffLoss$).

Desalination

In case that in the region exists desalinated water demand, the system has to provide the demanded amount of water every hour. Water storage at supply side provides flexibility to the system. Desalination units are located on the seashore and they can optimize the work in order to decrease the total system cost. Water demand and water storage balance is described in Eqs. (22-23).

Water desalination units produce the water and store it in the water storage, desalinated water production is limited by optimal capacities of enabled desalination plants and storage technologies Eqs. (24-25). Power, heat and gas consumption for desalination units operation as shown in Eqs. (24-26) are included in the power, heat and gas balance equations on demand side. The water pumping electricity demand according to Eq. (27) and cost is calculated based on the pumping capacity of the system, hourly water demand, weighted average length and head of the piping system.

$$\forall h \in [1,8760] \sum_t^{tech} W_{des,t,h} + W_{stor,disch,h} - W_{stor,ch,h} = W_{demand,h} \quad (22)$$

$$\forall h \in [1,8760] SoC_{stor,h} = SoC_{stor,h-1} + W_{stor,ch,h} - W_{stor,disch,h} \quad (23)$$

$$\forall h \in [1,8760] W_{des,t,h} \leq instCapDes_t \quad (24)$$

$$\forall h \in [1,8760] SoC_{stor,h} \leq instCapStor \quad (25)$$

$$\forall h \in [1,8760] E_{heat,h} = \sum_t^{tech} W_{des,t,h} \cdot heatConst_t \quad (24)$$

$$\forall h \in [1,8760] E_{el,h} = \sum_t^{tech} W_{des,t,h} \cdot elConst_t - \sum_t^{tech} W_{des,t,h} \cdot elProd_t \quad (25)$$

$$\forall h \in [1,8760] E_{gas,h} = \sum_t^{tech} W_{des,t,h} \cdot gasConst_t \quad (26)$$

$$\forall h \in [1,8760] E_{elPump,h} = \sum_t^{tech} W_{des,t,h} \times (elConst_{vPump} \cdot alt + elConst_{hPump} \cdot dist) \quad (27)$$

Abbreviations: hour (h), desalination technology (t), desalinated water (W_{des}), water storage discharge ($W_{stor,disch}$), water storage charge ($W_{stor,ch}$), water demand (W_{demand}), installed desalination technology capacity ($instCapDes$), desalination heat demand (E_{heat}), desalination electricity demand (E_{el}), desalination gas demand (E_{gas}), desalination heat consumption ($heatCons$), desalination electricity consumption ($elCons$), desalination electricity production ($elProd$), desalination gas consumption ($gasCons$), water pumping electricity demand (E_{elPump}), horizontal water pumping electricity consumption ($elCons_{hPump}$), vertical water pumping electricity consumption ($elCons_{vPump}$), pumping distance ($dist$), pumping altitude difference (alt), water storage state of charge h (SoC_{stor}), installed capacity of the water storage ($instCapStor$).

CO₂ Removal

The energy system can capture additional amounts of CO₂ from atmosphere for the permanent storage, this CO₂ captured by DAC and stored in CO₂ buffer storage. The system will balance hourly DAC and CO₂ buffer operation in order to balance hourly CO₂ removal demand.

Transport and Fuel Production

Transportation demand is expressed in transportation demand in (metric) ton kilometers (t-km) for freight and passenger kilometers (p-km) for passengers. Power and fuels consumption for a given mix of transportation means operation are included in the Power, Heat and gas (H₂, CH₄) balance equations on the demand side.

Instead of presenting equations, this section is described in a qualitative way, as to how the transport sector is modelled.

The transportation demand for freight and passengers is allocated to the transportation modes road, rail, marine and aviation. For the case of the road mode this transportation demand is further allocated to the segments for light duty vehicles, buses and 2/3-wheeler for passengers and medium and heavy duty vehicles for freight. The thus allocated transportation demand is then allocated to powertrain types to cover the allocated demand. The powertrains are BEV, FCEV, PHEV and ICE for the road mode. The used fuel types for rail are electricity and liquid hydrocarbons, for marine are electricity, LNG, LH₂ and liquid hydrocarbons and for aviation the fuel types are electricity, LH₂ and liquid hydrocarbons.

All such allocated demand to the respective powertrains and fuel types is then linked to efficiency assumptions of the respective conversion technologies for the transition period from 2015 to 2050. This then leads to final energy demand for the fuels: electricity, liquid hydrocarbons, LH₂ and LNG. These fuels are then supplied by respective fuel production which transitions from the current mix of fuels to a fully sustainable fuel mix through the transition. All the applied assumptions are summarised in Breyer et al.⁸ and Khalili et al.¹¹⁹. Furthermore, the fuel shares of the transportation modes in the road segment are based directly or indirectly on levelised cost of mobility (LCOM) considerations for newly sold vehicles, which change the stock of vehicles according to the lifetime composition of the existing stock. Vehicle stock and overall demand data are then linked to specific energy demand values to calculate demand of fuels and electricity for the transport sector.

Fuel Production for Transport

The fuel production comprises electricity and methane, which is also described for the power sector. Methane is converted by a liquefaction unit to LNG. Hydrogen as a fuel is also partly described for the power sector, however for the transport sector in addition steam methane reforming (SMR) is part of the available components. Marine and aviation also requires LH₂, which is represented in the model by a respective liquefaction unit. Liquid hydrocarbons represents fuels such as diesel, gasoline, jetfuel, biofuels, and synthetic fuels. Biofuels are assumed to remain stable by volume as of 2015, whereas the remaining liquid hydrocarbon demand, which cannot be substituted by other fuel options, is covered by fossil fuels in the begin of the transition and indirect electrified synthetic fuels by 2050. This requires components such as fossil fuel refineries to represent the cost for converting crude oil into refined fuels, and for synthetic fuels Fischer-Tropsch units, and feeding CO₂ DAC and water electrolysers, heat recovery and again a supplying electricity system.

Biogas and Biomethane

The energy system can produce GHG neutral methane for needs of the sectors Power, Heat, Transport and Industry. The first option is upgrading the available biogas to biomethane. The amount of upgraded biogas cannot be more than the urbanisation level of the region, but not more than 70% of all biogas. Biomethane can be stored in the gas storage. The second option is power-to-gas. Hydrogen produced with water electrolysis and CO₂ from DAC units is used as raw material for the methanation units. Produced SNG can be also stored in the gas storage.

PV Prosumers

The system also includes distributed generation and self-consumption of residential, commercial and industrial electricity consumers (PV prosumers) by installing respective capacities of rooftop PV systems and batteries. For these prosumers the target function is minimal cost of consumed energy calculated as sum of self-generation, annual cost and cost of electricity consumed from the grid, minus benefits from selling of excess energy.

A.3. Results Preparation and Cost Calculations

All optimisation results are collected and converted from the LP form to the Matlab structure. This structure contains all information about the system: installed capacities of all system elements, its operation modes, energy, fuel and other products flows.

Data on the structure and operations of the energy system in combination with financial and technical assumptions give the full description of the system. Based on these numbers it is possible to calculate annual costs of each component and the whole system, allocate costs to specific sectors, calculate costs of products (electricity, heat, synthetic fuels, water) and different components of this costs (primary generation, storage, transmission, curtailment components of electricity prices etc.).

The total annualised cost of the system is calculated as sum of all sectors costs Eq. (28), which includes annualized capital cost and operational costs of all system elements Eq. (29):

$$\begin{aligned} totalCost_{sys} = & elSysCost + elProsCost + heatSysCost + heatIndCost \\ & + transpSysCost + industrSysCost \end{aligned} \quad (28)$$

$$totalCost_{sys} = \sum_{t=1}^{tech} (CAPEX_t \cdot crf_t + OPEXfix_t) \cdot Cap_t + OPEXvar_t \cdot E_{gen,t} \quad (29)$$

$$crf_t = \frac{WACC \cdot (1 + WACC)^{N_t}}{(1 + WACC)^{N_t} - 1} \quad (30)$$

Abbreviations: total annualised cost of the system ($totalCost_{sys}$), annualised cost of the centralised power sector ($elSysCost$), annualised cost of the electricity prosumers sector ($elProsCost$), annualised cost of the centralised heat sector ($heatSysCost$), annualised cost of the individual heat sector ($heatIndCost$), annualised cost of the transport sector ($transpSysCost$), annualised cost of the industrial sector ($industrSysCost$), all technologies ($tech$), technology (t), capital expenditures (CAPEX), capital recovery factor for technology t (crf_t) Eq. (30), annual fixed operational expenditures ($OPEXfix$), variable operational expenditures ($OPEXvar$), installed capacity of the technology t (Cap_t), annual output for the technology t ($E_{gen,t}$), weighted average cost of capital (WACC), lifetime for technology t (N_t).

Total levelised cost of electricity in the system ($LCOE_{total}$) is calculated as the electricity demand weighted average of the centralised power system LCOE ($LCOE_{sys}$) and prosumers sector LCOE ($LCOE_{pros}$), the formula is presented in Eq. (31). Centralised power system LCOE is comprised of levelised cost of consumed electricity ($LCOE_{prim}$), levelised cost of storage (LCOS), levelised cost of curtailed electricity (LCOC), levelised cost of electricity transition (LCOT) and levelised cost of prosumers feed-in reimbursement (LCOFS), Eq. (32). For the prosumers sector total LCOE comprised of the levelised cost of consumed electricity ($LCOE_{prim}$), levelised cost of storage (LCOS), and levelised cost of prosumers feed-in reimbursement (LCOFS), Eq. (33). Levelised cost of generated electricity is calculated as total annualised cost of the electricity generation system divided by total annual generation Eq. (34), in this calculations operational costs include costs of fuel and GHG emissions cost per unit of the generated electricity, electricity generation systems also include part of fuel production facilities, which are used for fuel production for power system generators. Levelised cost of consumed electricity is calculated based on the cost of the generated electricity ($LCOE_{gen}$), excluding electricity lost due to curtailment, storage and transmission systems losses Eq. (35).

Levelised cost of storage is calculated as annualised cost of storage system equipment and annual cost of electricity losses divided by total electricity consumption Eq. (36), storage systems also include part of fuel production facilities, which are used for fuel production for the storage system generators (e.g. for Power-to-Gas – Gas-to-Power). Levelised cost of curtailment is calculated as annual cost of curtailed electricity divided by total electricity consumption Eq. (37). Levelised cost of transmission is calculated area total annualised cost of power grid equipment and annual cost of electricity losses divided by total electricity consumption, and multiplied by regional grid utilisation weights Eq. (38), where regional grid utilisation weights are average of region shares in total export and import of energy Eq. (39).

$$LCOE_{total,r} = (LCOE_{sys,r} \cdot El_{consSys,r} + LCOE_{pros,r} \cdot El_{consPros,r}) / (El_{consSys,r} + El_{consPros,r}) \quad (31)$$

$$LCOE_{sys,r} = LCOE_{prim,r} + LCOS_r + LCOC_r + LCOT_r + LCOFS_r \quad (32)$$

$$LCOE_{pros,r} = LCOE_{prim,r} + LCOS_r - LCOFS_r \quad (33)$$

$$LCOE_{gen,r} = \frac{\sum_{t=1}^{Gen} (CAPEX_t \cdot crf_t + OPEXfix_t) \cdot Cap_{t,r} + OPEXvar_t \cdot El_{gen,t,r}}{El_{gen,r}} \quad (34)$$

$$LCOE_{prim,r} = \frac{LCOE_{gen,r} \cdot (El_{gen,r} - El_{curt,r} - El_{storLoss,r} - El_{transLoss,r})}{El_{cons,r}} \quad (35)$$

$$LCOS_r = \frac{\sum_{t=1}^{Stor} (CAPEX_t \cdot crf_t + OPEXfix_t) \cdot Cap_{t,r} + OPEXvar_t \cdot E_{out,t,r} + LCOE_{gen,r} \cdot El_{storLoss,r}}{El_{cons,r}} \quad (36)$$

$$LCOC_r = \frac{LCOE_{gen,r} \cdot El_{curt,r}}{El_{cons,r}} \quad (37)$$

$$LCOT_r = RegShare_r \cdot \frac{\sum_r^{Reg} \sum_{t=1}^{trans} (CAPEX_t \cdot crf_t + OPEXfix_t) \cdot Cap_{t,r} + OPEXvar_t \cdot El_{out,t,r} + LCOE_{gen,r} \cdot El_{transLoss,r}}{El_{cons,r}} \quad (38)$$

$$RegShare_r = 0.5 \cdot \frac{Import_r}{\sum_r Import_r} + 0.5 \cdot \frac{Export_r}{\sum_r Export_r} \quad (39)$$

$$LCOFS_r = \frac{feedInTarif_r \cdot El_{prosToGrid,r}}{El_{cons,r}} \quad (40)$$

Abbreviations: region (r), total levelised cost of electricity in the system ($LCOE_{total}$), centralised system levelised cost of electricity ($LCOE_{sys}$), prosumers sector levelised cost of electricity ($LCOE_{pros}$), centralised system electricity consumption ($El_{consSys}$), prosumers sector electricity consumption ($El_{consPros}$), consumed electricity LCOE ($LCOE_{prim}$), levelised cost of stored electricity ($LCOS$), levelised cost of curtailed electricity ($LCOC$), levelised cost of prosumers feed-in reimbursement ($LCOFS$), generated electricity LCOE ($LCOE_{gen}$), power generation technologies (Gen), storage technologies ($Stor$), power transmission technologies ($trans$), technology (t), capital expenditures ($CAPEX$), capital recovery factor for technology t (crf_t), annual fixed operational expenditures ($OPEX_{fix}$), variable operational expenditures ($OPEX_{var}$), installed capacity of the technology t (Cap_t), annual output for the technology t ($El_{gen,t}$), annual electricity generation (El_{gen}), annual electricity curtailment (El_{curt}), annual storage loss ($El_{storLoss}$), annual grid loss ($El_{transLoss}$), annual electricity consumption (El_{cons}), annual output of storage t ($E_{out,t}$), annual export of grid technology t ($El_{out,t}$), electricity exported by region r ($Export$), electricity imported by region r ($Import$), feed-in reimbursement ($feedInTarif$), electricity sold by prosumers to the grid ($EL_{prosToGrid}$).

The levelised cost of heat (LCOH) is calculated as the weighted average of the centralised and individual systems LCOH of heat Eq. (41). The centralised heat system LCOH ($LCOH_{sys}$) and individual heat system LCOH ($LCOH_{ind}$) are calculated as annualised cost of heat system equipment and annual cost of electricity consumption by heating equipment divided by total heat consumption Eq. (42,43). In both formulas, operational expenditures include cost of fuel and GHG emissions per unit of generated heat. The heat systems also include part of fuel production facilities, which are used for fuel production for heat generators. Cogeneration plants costs only included in the power system.

Levelised cost of transportation (LCOM) is calculated as sum of annualised cost of all transport fleet, cost of consumed fuel and electricity, GHG emission cost, divided by transportation demand Eq. (44).

Levelised cost of the industrial sector products (LCOP): levelised cost of Gas (LCOG), liquid fuel (LCOF), water (LCOW), of CO_2 direct air capture (LCOD) are calculated as sum of annualised cost of the equipment and cost of annually consumed heat, electricity divided by total annual consumption of the product Eq. (45).

$$LCOH_{total,r} = (LCOH_{sys,r} \cdot He_{consSys,r} + LCOH_{ind,r} \cdot He_{consInd,r}) / (He_{consSys,r} + He_{consInd,r}) \quad (41)$$

$$LCOH_{sys,r} = \frac{\sum_{t=1}^{heat} (CAPEX_t \cdot crf_t + OPEX_{fix,t}) \cdot Cap_{t,r} + OPEX_{var,t} \cdot He_{out,t,r} + LCOE_{sys,r} \cdot El_{demSysHeat,r}}{He_{consSys,r}} \quad (42)$$

$$LCOH_{ind,r} = \frac{\sum_{t=1}^{heat} (CAPEX_t \cdot crf_t + OPEX_{fix,t}) \cdot Cap_{t,r} + OPEX_{var,t} \cdot He_{out,t,r} + ElPrice_r \cdot El_{demIndHeat,r}}{He_{consInd,r}} \quad (43)$$

$$LCOM_r = \frac{\sum_{t=1}^{Mob} (CAPEX_t \cdot crf_t + OPEX_{fix,t}) \cdot Cap_{t,r} + FuPrice_{t,r} \cdot FuCons_{t,r}}{TR_{dem,r}} \quad (44)$$

$$LCOP_r = \frac{\sum_{t=1}^{tech} (CAPEX_t \cdot crf_t + OPEX_{fix,t}) \cdot Cap_{t,r} + OPEX_{var,t} \cdot Pr_{out,t,r} + LCOE_{sys,r} \cdot El_{cons,t,r} + LCC}{Pr_{cons,r}} \quad (45)$$

Abbreviations: region (r), total levelised cost of heat in the system ($LCOH_{total}$), centralised system levelised cost of heat ($LCOE_{sys}$), individual heat sector levelised cost of heat ($LCOH_{ind}$), centralised system heat consumption ($He_{consSys}$), individual heat sector heat consumption ($He_{consPros}$), heat generation technologies ($heat$), transportation technologies (Mob), industrial sector production technologies ($tech$), technology (t), capital expenditures ($CAPEX$), capital recovery factor for technology t (crf_t), annual fixed operational expenditures ($OPEX_{fix}$), variable operational expenditures ($OPEX_{var}$), installed capacity of the technology t (Cap_t), annual output for the technology t ($He_{out,t}$), centralised system levelised cost of electricity ($LCOE_{sys}$), retail price of electricity ($ElPrice$), electricity consumed by centralised heat system heaters ($El_{demSysHeat}$), electricity consumed by individual heat system heaters ($El_{demIndHeat}$), fuel price for transportation technology t ($FuPrice_t$), fuel consumption for transportation technology t ($FuCons_t$), transportation demand (TR_{dem}), annual product production (Pr_{out}), electricity consumption for the production (El_{cons}), annual heat consumption for the production (He_{cons}), annual product consumption (Pr_{cons}).

Technical and Financial Assumptions

The following tables show the various technical and financial assumptions that were factored into the modelling of the global energy transition.

Table A3: Technical and financial assumptions of energy system technologies used in the energy transition from 2015 to 2050.

Technologies		Units	2015	2020	2025	2030	2035	2040	2045	2050	Ref
PV rooftop - residential	Capex	€/kW _{el}	1360	1169	966	826	725	650	589	537	[120]
	Opex fix	€/(kW _{el} a)	20	17.6	15.7	14.2	12.8	11.7	10.7	9.8	
	Opex var	€/(kWh _{el})	0	0	0	0	0	0	0	0	
	Lifetime	years	30	30	35	35	35	40	40	40	
PV rooftop - commercial	Capex	€/kW _{el}	1360	907	737	623	542	484	437	397	[120]
	Opex fix	€/(kW _{el} a)	20	17.6	15.7	14.2	12.8	11.7	10.7	9.8	
	Opex var	€/(kWh _{el})	0	0	0	0	0	0	0	0	
	Lifetime	years	30	30	35	35	35	40	40	40	
PV rooftop - industrial	Capex	€/kW _{el}	1360	682	548	459	397	353	318	289	[120]
	Opex fix	€/(kW _{el} a)	20	17.6	15.7	14.2	12.8	11.7	10.7	9.8	
	Opex var	€/(kWh _{el})	0	0	0	0	0	0	0	0	
	Lifetime	years	30	30	35	35	35	40	40	40	
PV optimally tilted	Capex	€/kW _{el}	1000	580	466	390	337	300	270	246	[120]
	Opex fix	€/(kW _{el} a)	15	13.2	11.8	10.6	9.6	8.8	8	7.4	
	Opex var	€/(kWh _{el})	0	0	0	0	0	0	0	0	
	Lifetime	years	30	30	35	35	35	40	40	40	
PV single-axis tracking	Capex	€/kW _{el}	1150	638	513	429	371	330	297	271	[120, 121]
	Opex fix	€/(kW _{el} a)	17.25	15	13	12	11	10	9	8	
	Opex var	€/(kWh _{el})	0	0	0	0	0	0	0	0	
	Lifetime	years	30	30	35	35	35	40	40	40	
Wind onshore	Capex	€/kW _{el}	1250	1150	1060	1000	965	940	915	900	[122]
	Opex fix	€/(kW _{el} a)	25	23	21	20	19	19	18	18	
	Opex var	€/(kWh _{el})	0	0	0	0	0	0	0	0	
	Lifetime	years	25	25	25	25	25	25	25	25	
Wind offshore	Capex	€/kW _{el}	3220	2880	2700	2580	2460	2380	2320	2280	[122]
	Opex fix	€/(kW _{el} a)	112.7	92.16	83.7	77.4	71.34	66.64	58	52.44	
	Opex var	€/(kWh _{el})	0	0	0	0	0	0	0	0	
	Lifetime	years	20	25	25	25	25	25	25	25	
Hydro Reservoir/ Dam	Capex	€/kW _{el}	1650	1650	1650	1650	1650	1650	1650	1650	[123]
	Opex fix	€/(kW _{el} a)	49.5	49.5	49.5	49.5	49.5	49.5	49.5	49.5	
	Opex var	€/(kWh _{el})	0.003	0.003	0.003	0.003	0.003	0.003	0.003	0.003	
	Lifetime	years	50	50	50	50	50	50	50	50	
Hydro Run-of-River	Capex	€/kW _{el}	2560	2560	2560	2560	2560	2560	2560	2560	[123]
	Opex fix	€/(kW _{el} a)	76.8	76.8	76.8	76.8	76.8	76.8	76.8	76.8	
	Opex var	€/(kWh _{el})	0.005	0.005	0.005	0.005	0.005	0.005	0.005	0.005	
	Lifetime	years	50	50	50	50	50	50	50	50	
Geothermal power	Capex	€/kW _{el}	5250	4970	4720	4470	4245	4020	3815	3610	[123, 124]
	Opex fix	€/(kW _{el} a)	80	80	80	80	80	80	80	80	
	Opex var	€/(kWh _{el})	0	0	0	0	0	0	0	0	
	Lifetime	years	40	40	40	40	40	40	40	40	
Coal PP	Capex	€/kW _{el}	1500	1500	1500	1500	1500	1500	1500	1500	[125, 126]
	Opex fix	€/(kW _{el} a)	20	20	20	20	20	20	20	20	
	Opex var	€/(kWh)	0.001	0.001	0.001	0.001	0.001	0.001	0.001	0.001	
	Lifetime	years	40	40	40	40	40	40	40	40	
Nuclear PP	Capex	€/kW _{el}	6210	6003	6003	5658	5658	5244	5244	5175	[125, 127, 128]
	Opex fix	€/(kW _{el} a)	162	157	157	137	137	116	116	109	
	Opex var	€/(kWh _{el})	0.003	0.003	0.003	0.003	0.003	0.003	0.003	0.003	
	Lifetime	years	40	40	40	40	40	40	40	40	
CCGT	Capex	€/kW _{el}	775	775	775	775	775	775	775	775	[125]
	Opex fix	€/(kW _{el} a)	19.4	19.4	19.4	19.4	19.4	19.4	19.4	19.4	
	Opex var	€/(kWh _{el})	0	0	0	0	0	0	0	0	
	Lifetime	years	35	35	35	35	35	35	35	35	
OCGT	Capex	€/kW _{el}	475	475	475	475	475	475	475	475	[129]
	Opex fix	€/(kW _{el} a)	14.25	14.25	14.25	14.25	14.25	14.25	14.25	14.25	
	Opex var	€/(kWh _{el})	0	0	0	0	0	0	0	0	
	Lifetime	years	35	35	35	35	35	35	35	35	

Steam turbine (CSP)	Capex	€/kW _{el}	760	740	720	700	670	640	615	600	
	Opex fix	€/(kW _{el} a)	15.2	14.8	14.4	14	13.4	12.8	12.3	12	
	Opex var	€/(kWh _{el})	0	0	0	0	0	0	0	0	
	Lifetime	years	25	25	25	25	30	30	30	30	
CHP NG Heating	Capex	€/kW _{el}	880	880	880	880	880	880	880	880	
	Opex fix	€/(kW _{el} a)	74.8	74.8	74.8	74.8	74.8	74.8	74.8	74.8	
	Opex var	€/(kWh _{el})	0.002	0.002	0.002	0.002	0.002	0.002	0.002	0.002	
	Lifetime	years	30	30	30	30	30	30	30	30	
CHP Oil Heating	Capex	€/kW _{el}	880	880	880	880	880	880	880	880	
	Opex fix	€/(kW _{el} a)	74.8	74.8	74.8	74.8	74.8	74.8	74.8	74.8	
	Opex var	€/(kWh _{el})	0.002	0.002	0.002	0.002	0.002	0.002	0.002	0.002	
	Lifetime	years	30	30	30	30	30	30	30	30	
CHP Coal Heating	Capex	€/kW _{el}	2030	2030	2030	2030	2030	2030	2030	2030	
	Opex fix	€/(kW _{el} a)	46.7	46.7	46.7	46.7	46.7	46.7	46.7	46.7	
	Opex var	€/(kWh _{el})	0.005	0.005	0.005	0.005	0.005	0.005	0.005	0.005	
	Lifetime	years	40	40	40	40	40	40	40	40	
CHP Biomass Heating	Capex	€/kW _{el}	3560	3300	3145	2990	2870	2750	2645	2540	
	Opex fix	€/(kW _{el} a)	81.9	75.9	72.3	68.8	66	63.3	60.8	58.4	
	Opex var	€/(kWh _{el})	0.003	0.003	0.003	0.003	0.003	0.003	0.003	0.003	
	Lifetime	years	25	25	25	25	25	25	25	25	
CHP Biogas	Capex	€/kW _{el}	503	429	400	370	340	326	311	296	
	Opex fix	€/(kW _{el} a)	20.1	17.2	16	14.8	13.6	13	12.4	11.8	
	Opex var	€/(kWh _{el})	0.001	0.001	0.001	0.001	0.001	0.001	0.001	0.001	
	Lifetime	years	30	30	30	30	30	30	30	30	
Waste incinerator	Capex	€/kW _{el}	5940	5630	5440	5240	5030	4870	4690	4540	
	Opex fix	€/(kW _{el} a)	267.3	253.4	244.8	235.8	226.4	219.2	211.1	204.3	
	Opex var	€/(kWh _{el})	0.007	0.007	0.007	0.007	0.007	0.007	0.007	0.007	
	Lifetime	years	30	30	30	30	30	30	30	30	
Biogas digester	Capex	€/kW _{th}	771	731	706	680	653	632	609	589	
	Opex fix	€/(kW _{th} a)	30.8	29.2	28.2	27.2	26.1	25.3	24.3	23.6	
	Opex var	€/(kWh _{th})	0	0	0	0	0	0	0	0	
	Lifetime	years	20	20	20	20	25	25	25	25	
Biogas upgrade	Capex	€/kW _{th}	340	290	270	250	230	220	210	200	
	Opex fix	€/(kW _{th} a)	27.2	23.2	21.6	20	18.4	17.6	16.8	16	[130]
	Opex var	€/(kWh _{th})	0	0	0	0	0	0	0	0	
	Lifetime	years	20	20	20	20	25	25	25	25	
CSP (solar field, parabolic trough)	Capex	€/kW _{th}	438.3	344.5	303.6	274.7	251.1	230.2	211.9	196	
	Opex fix	€/(kW _{th} a)	10.1	7.9	7	6.3	5.8	5.3	4.9	4.5	[72,131]
	Opex var	€/(kWh _{th})	0	0	0	0	0	0	0	0	
	Lifetime	years	25	25	25	25	25	25	25	25	
Residential Solar Heat Collectors - space heating	Capex	€/kW _{th}	1286	1214	1179	1143	1071	1000	929	857	
	Opex fix	€/(kW _{th} a)	14.8	14.8	14.8	14.8	14.8	14.8	14.8	14.8	
	Opex var	€/(kWh _{th})	0	0	0	0	0	0	0	0	
	Lifetime	years	20	25	25	30	30	30	30	30	
Residential Solar Heat Collectors - hot water	Capex	€/kW _{th}	485	485	485	485	485	485	485	485	
	Opex fix	€/(kW _{th} a)	4.85	4.85	4.85	4.85	4.85	4.85	4.85	4.85	
	Opex var	€/(kWh _{th})	0	0	0	0	0	0	0	0	
	Lifetime	years	15	15	15	15	15	15	15	15	
DH Rod Heating	Capex	€/kW _{th}	100	100	100	75	75	75	75	75	
	Opex fix	€/(kW _{th} a)	1.47	1.47	1.47	1.47	1.47	1.47	1.47	1.47	
	Opex var	€/(kWh _{th})	0.001	0.001	0.001	0.001	0.001	0.001	0.001	0.001	
	Lifetime	years	35	35	35	35	35	35	35	35	
DH Heat Pump	Capex	€/kW _{th}	700	660	618	590	568	554	540	530	
	Opex fix	€/(kW _{th} a)	2	2	2	2	2	2	2	2	
	Opex var	€/(kWh _{th})	0.002	0.002	0.002	0.002	0.002	0.002	0.002	0.002	
	Lifetime	years	25	25	25	25	25	25	25	25	
DH Natural gas Heating	Capex	€/kW _{th}	75	75	75	100	100	100	100	100	
	Opex fix	€/(kW _{th} a)	2.775	2.775	2.775	3.7	3.7	3.7	3.7	3.7	
	Opex var	€/(kWh _{th})	0.0002	0.0002	0.0002	0.0002	0.0002	0.0002	0.0002	0.0002	
	Lifetime	years	35	35	35	35	35	35	35	35	
DH Oil Heating	Capex	€/kW _{th}	75	75	75	100	100	100	100	100	
	Opex fix	€/(kW _{th} a)	2.775	2.775	2.775	3.7	3.7	3.7	3.7	3.7	
	Opex var	€/(kWh _{th})	0.0002	0.0002	0.0002	0.0002	0.0002	0.0002	0.0002	0.0002	
	Lifetime	years	35	35	35	35	35	35	35	35	
DH Coal Heating	Capex	€/kW _{th}	75	75	75	100	100	100	100	100	
	Opex fix	€/(kW _{th} a)	2.775	2.775	2.775	3.7	3.7	3.7	3.7	3.7	
	Opex var	€/(kWh _{th})	0.0002	0.0002	0.0002	0.0002	0.0002	0.0002	0.0002	0.0002	
	Lifetime	years	35	35	35	35	35	35	35	35	
DH Biomass	Capex	€/kW _{th}	75	75	75	100	100	100	100	100	

Heating	Opex fix	€/kW _{th} a)	2.8	2.8	2.8	3.7	3.7	3.7	3.7	3.7	
	Opex var	€/kWh _{th})	0.0002	0.0002	0.0002	0.0002	0.0002	0.0002	0.0002	0.0002	
	Lifetime	years	35	35	35	35	35	35	35	35	
DH Geothermal heat	Capex	€/kW _{th}	3936	3642	3384	3200	3180	3160	3150	3146	
	Opex fix	€/kW _{th} a)	144	133	124	117	116	115	115	115	
	Opex var	€/kWh _{th})	0	0	0	0	0	0	0	0	
Local Rod Heating	Lifetime	years	22	22	22	22	22	22	22	22	
	Capex	€/kW _{th}	800	800	800	800	800	800	800	800	
	Opex fix	€/kW _{th} a)	10	10	10	10	10	10	10	10	
Local Heat Pump	Opex var	€/kWh _{th})	0	0	0	0	0	0	0	0	
	Lifetime	years	30	30	30	30	30	30	30	30	
	Capex	€/kW _{th}	800	780	750	730	706	690	666	650	
Local Natural gas heating	Opex fix	€/kW _{th} a)	16	15.6	15	7.3	7.1	6.9	6.7	6.5	
	Opex var	€/kWh _{th})	0	0	0	0	0	0	0	0	
	Lifetime	years	20	20	20	20	20	20	20	20	
Local Oil Heating	Capex	€/kW _{th}	800	800	800	800	800	800	800	800	
	Opex fix	€/kW _{th} a)	27	27	27	27	27	27	27	27	
	Opex var	€/kWh _{th})	0	0	0	0	0	0	0	0	
Local Coal Heating	Lifetime	years	22	22	22	22	22	22	22	22	
	Capex	€/kW _{th}	440	440	440	440	440	440	440	440	
	Opex fix	€/kW _{th} a)	18	18	18	18	18	18	18	18	
Local Biomass Heating	Opex var	€/kWh _{th})	0	0	0	0	0	0	0	0	
	Lifetime	years	20	20	20	20	20	20	20	20	
	Capex	€/kW _{th}	500	500	500	500	500	500	500	500	
Local Biogas Heating	Opex fix	€/kW _{th} a)	10	10	10	10	10	10	10	10	
	Opex var	€/kWh _{th})	0	0	0	0	0	0	0	0	
	Lifetime	years	15	15	15	15	15	15	15	15	
Water electrolysis	Capex	€/kW _{H2}	675	675	675	750	750	750	750	675	
	Opex fix	€/kW _{H2} a)	2	2	2	3	3	3	3	2	
	Opex var	€/kWh _{H2})	0	0	0	0	0	0	0	0	
Methanation	Lifetime	years	20	20	20	20	20	20	20	20	
	Capex	€/kW _{H2}	800	800	800	800	800	800	800	800	
	Opex fix	€/kW _{H2} a)	27	27	27	27	27	27	27	27	
CO ₂ direct air capture	Opex var	€/kWh _{H2})	0	0	0	0	0	0	0	0	
	Lifetime	years	22	22	22	22	22	22	22	22	
	Capex	€/kW _{H2}	800	685	500	363	325	296	267	248	[132,133]
Fischer-Tropsch unit	Opex fix	€/kW _{H2} a)	32	27	20	12.7	11.4	10.4	9.4	8.7	
	Opex var	€/kWh _{H2})	0.001	0.001	0.001	0.001	0.001	0.001	0.001	0.001	
	Lifetime	years	30	30	30	30	30	30	30	30	
Battery storage	Capex	€/kW _{CH4}	547	502	368	278	247	226	204	190	
	Opex fix	€/kW _{CH4} a)	25.16	23.09	16.93	12.79	11.36	10.4	9.38	8.74	[132,133]
	Opex var	€/kWh _{CH4})	0.002	0.002	0.002	0.002	0.002	0.002	0.002	0.002	
Battery interface	Lifetime	years	30	30	30	30	30	30	30	30	
	Capex	€/tCO ₂ a)	1000	730	493	335	274.4	234	210.6	195	
	Opex fix	€/tCO ₂ a)	40	29.2	19.7	13.4	11	9.4	8.4	7.8	
Fischer-Tropsch unit	Opex var	€/tCO ₂ a)	0	0	0	0	0	0	0	0	
	Lifetime	years	20	20	30	25	30	30	30	30	
	Capex	€/kW _{FTLi}	947	947	947	947	947	852.3	852.3	852.3	
Battery storage	Opex fix	€/kW _{FTLi}	28.41	28.41	28.41	28.41	28.41	25.57	25.57	25.57	
	Opex var	€/kW _{FTLi}	0	0	0	0	0	0	0	0	
	Lifetime	years	30	30	30	30	30	30	30	30	
Battery storage	Capex	€/kW _{el}	400	270	182	134	108	92	78	70	
	Opex fix	€/kW _{el} a)	24	9	5	3.75	3	2.5	2.125	1.875	[134]
	Opex var	€/kWh _{el})	0	0	0	0	0	0	0	0	
Battery interface	Lifetime	years	15	20	20	20	20	20	20	20	
	Capex	€/kW _{el}	200	135	91	67	54	46	39	35	
	Opex fix	€/kW _{el} a)	0	0	0	0	0	0	0	0	
Battery interface	Opex var	€/kWh _{el})	0	0	0	0	0	0	0	0	
	Lifetime	years	15	20	20	20	20	20	20	20	

Battery PV prosumer - residential storage	Capex	€/kWh _{el}	603	407	280	209	170	146	124	111
	Opex fix	€/(kWh _{el} a)	36.2	13.6	7.7	5.8	4.7	4	3.4	3
	Opex var	€/(kWh _{el})	0	0	0	0	0	0	0	0
	Lifetime	years	15	20	20	20	20	20	20	20
Battery PV prosumer - residential interface	Capex	€/kW _{el}	302	204	140	104	85	73	62	56
	Opex fix	€/(kW _{el} a)	0	0	0	0	0	0	0	0
	Opex var	€/(kWh _{el})	0	0	0	0	0	0	0	0
	Lifetime	years	15	20	20	20	20	20	20	20
Battery PV prosumer - commercial storage	Capex	€/kWh _{el}	513	346	235	174	141	120	102	91
	Opex fix	€/(kWh _{el} a)	30.8	11.5	6.5	4.9	3.9	3.3	2.8	2.5
	Opex var	€/(kWh _{el})	0	0	0	0	0	0	0	0
	Lifetime	years	15	20	20	20	20	20	20	20
Battery PV prosumer - commercial interface	Capex	€/kW _{el}	256	173	117	87	70	60	51	46
	Opex fix	€/(kW _{el} a)	0	0	0	0	0	0	0	0
	Opex var	€/(kWh _{el})	0	0	0	0	0	0	0	0
	Lifetime	years	15	20	20	20	20	20	20	20
Battery PV prosumer - industrial storage	Capex	€/kWh _{el}	435	294	198	146	118	100	85	76
	Opex fix	€/(kWh _{el} a)	26.1	9.8	5.4	4.1	3.3	2.7	2.3	2
	Opex var	€/(kWh _{el})	0	0	0	0	0	0	0	0
	Lifetime	years	15	20	20	20	20	20	20	20
Battery PV prosumer - industrial interface	Capex	€/kW _{el}	218	147	99	73	59	50	42	38
	Opex fix	€/(kW _{el} a)	0	0	0	0	0	0	0	0
	Opex var	€/(kWh _{el})	0	0	0	0	0	0	0	0
	Lifetime	years	15	20	20	20	20	20	20	20
PHES	Capex	€/kWh _{el}	7.7	7.7	7.7	7.7	7.7	7.7	7.7	7.7
	Opex fix	€/(kWh _{el} a)	1.335	1.335	1.335	1.335	1.335	1.335	1.335	1.335
	Opex var	€/(kWh _{el})	0	0	0	0	0	0	0	0
	Lifetime	years	50	50	50	50	50	50	50	50
PHES interface	Capex	€/kW _{el}	650	650	650	650	650	650	650	650
	Opex fix	€/(kW _{el} a)	0	0	0	0	0	0	0	0
	Opex var	€/(kWh _{el})	0	0	0	0	0	0	0	0
	Lifetime	years	50	50	50	50	50	50	50	50
A-CAES	Capex	€/kWh _{el}	35	35	32.6	31.1	30.3	29.8	27.7	26.3
	Opex fix	€/(kWh _{el} a)	0.53	0.53	0.50	0.47	0.46	0.45	0.42	0.40
	Opex var	€/(kWh _{el})	0	0	0	0	0	0	0	0
	Lifetime	years	40	55	55	55	55	55	55	55
A-CAES interface	Capex	€/kW _{el}	600	600	558	530	518	510	474	450
	Opex fix	€/(kW _{el} a)	0	0	0	0	0	0	0	0
	Opex var	€/(kWh _{el})	0	0	0	0	0	0	0	0
	Lifetime	years	40	55	55	55	55	55	55	55
Gas Storage	Capex	€/kWh _{el}	0.05	0.05	0.05	0.05	0.05	0.05	0.05	0.05
	Opex fix	€/(kWh _{el} a)	0.001	0.001	0.001	0.001	0.001	0.001	0.001	0.001
	Opex var	€/(kWh _{el})	0	0	0	0	0	0	0	0
	Lifetime	years	50	50	50	50	50	50	50	50
Gas Storage interface	Capex	€/kW _{th}	25.8	25.8	25.8	25.8	25.8	25.8	25.8	25.8
	Opex fix	€/(kW _{th} a)	31	31	31	31	31	31	31	31
	Opex var	€/(kWh _{th})	36.2	36.2	36.2	36.2	36.2	36.2	36.2	36.2
	Lifetime	years	41.4	41.4	41.4	41.4	41.4	41.4	41.4	41.4
Hot Heat Storage	Capex	€/kWh _{th}	50.8	41.8	32.7	26.8	23.3	21	19.3	17.5
	Opex fix	€/(kWh _{th} a)	0.76	0.63	0.49	0.4	0.35	0.32	0.29	0.26
	Opex var	€/(kWh _{th})	0	0	0	0	0	0	0	0
	Lifetime	years	25	25	25	25	30	30	30	30
District Heat Storage	Capex	€/kWh _{th}	50	40	30	30	25	20	20	20
	Opex fix	€/(kWh _{th} a)	0.8	0.6	0.5	0.5	0.4	0.3	0.3	0.3
	Opex var	€/(kWh _{th})	0	0	0	0	0	0	0	0
	Lifetime	years	25	25	25	25	30	30	30	30
Hydrogen Storage	Capex	€/kWh _{th}	0.24	0.24	0.24	0.24	0.24	0.24	0.24	0.24
	Opex fix	€/(kWh _{th} a)	0.01	0.01	0.01	0.01	0.01	0.01	0.01	0.01
	Opex var	€/(kWh _{th})	0	0	0	0	0	0	0	0
	Lifetime	years	15	15	15	15	15	15	15	15
Hydrogen	Capex	€/kW _{th}	255.9	255.9	255.9	255.9	255.9	255.9	255.9	255.9

[135]

Storage interface	Opex fix	€/kW _{th} a)	10.23	10.23	10.23	10.23	10.23	10.23	10.23	10.23	[135]
	Opex var	€/kW _{th} .th)	0	0	0	0	0	0	0	0	
	Lifetime	years	15	15	15	15	15	15	15	15	
CO₂ Storage	Capex	€/ton	142	142	142	142	142	142	142	142	[136]
	Opex fix	€/(ton a)	9.94	9.94	9.94	9.94	9.94	9.94	9.94	9.94	
	Opex var	€/ton	0	0	0	0	0	0	0	0	
Reverse Osmosis Seawater Desalination	Capex	€/(m ³ /day)	1150	960	835	725	630	550	480	415	[137]
	Opex fix	€/(m ³ /day a)	46	38.4	33.4	29	25.2	22	19.2	16.6	
	Consumption	kWh _{th} /m ³	0	0	0	0	0	0	0	0	
	Lifetime	years	25	25	30	30	30	30	30	30	
	Consumption	kWh _{el} /m ³	4.1	3.6	3.35	3.15	3	2.85	2.7	2.6	
Multi Stage Flash Standalone	Capex	€/(m ³ /day)	2000	2000	2000	2000	2000	2000	2000	2000	[137]
	Opex fix	€/(m ³ /day a)	100	100	100	100	100	100	100	100	
	Consumption	kWh _{th} /m ³	85	85	85	85	85	85	85	85	
	Lifetime	years	25	25	25	25	25	25	25	25	
Multi Stage Flash Cogeneration	Capex	€/(m ³ /day)	3069	3069	3069	3069	3069	3069	3069	3069	[137]
	Opex fix	€/(m ³ /day a)	121.4	121.4	121.4	121.4	121.4	121.4	121.4	121.4	
	Consumption	kWh _{th} /m ³	202.5	202.5	202.5	202.5	202.5	202.5	202.5	202.5	
	Lifetime	years	25	25	25	25	25	25	25	25	
Multi Effect Distillation Standalone	Capex	€/(m ³ /day)	1438	1200	1044	906.3	787.5	687.5	600	518.8	[137]
	Opex fix	€/(m ³ /day a)	47.44	39.60	34.44	29.91	25.99	22.69	19.80	17.12	
	Consumption	kWh _{th} /m ³	68	51	44	38	32	28	28	28	
	Lifetime	years	25	25	25	25	25	25	25	25	
Multi Effect Distillation Cogeneration	Capex	€/(m ³ /day)	2150	2150	2150	2150	2150	2150	2150	2150	[137]
	Opex fix	€/(m ³ /day a)	61.69	61.69	61.69	61.69	61.69	61.69	61.69	68.81	
	Consumption	kWh _{th} /m ³	168	168	168	168	168	168	168	168	
	Lifetime	years	25	25	25	25	25	25	25	25	
Water Storage	Capex	€/m ³	64.59	64.59	64.59	64.59	64.59	64.59	64.59	64.59	[137]
	Opex fix	€/(m ³ a)	1.3	1.3	1.3	1.3	1.3	1.3	1.3	1.3	
	Opex var	€/m ³	0	0	0	0	0	0	0	0	
	Lifetime	years	50	50	50	50	50	50	50	50	

Table A4: Energy to power ratio and self-discharge rates of storage technologies.

Technology	Efficiency [%]	Energy/Power Ratio [h]	Self-Discharge [%/h]	Ref.
Battery	90	6	0	[138]
PHES	85	8	0	[123]
A-CAES	70	100	0.1	[123]
TES	90	8	0.2	[138]
Gas storage	100	80 24	0	[138]

Table A5: Financial assumptions for the fossil-nuclear fuel prices and GHG emission cost. The referenced values are all till 2040 and are kept stable for later periods (fuels) or are assumed to further increase for matching the Paris Agreement (GHG emissions).

Component	Unit	2015	2020	2025	2030	2035	2040	2045	2050	Ref.
Coal	€/MWh _{th}	7.7	7.7	8.4	9.2	10.2	11.1	11.1	11.1	[139]
Fuel oil	€/MWh _{th}	52.5	35.2	39.8	44.4	43.9	43.5	43.5	43.5	[129]
Fossil gas	€/MWh _{th}	21.8	22.2	30.0	32.7	36.1	40.2	40.2	40.2	[139]
Uranium	€/MWh _{th}	2.6	2.6	2.6	2.6	2.6	2.6	2.6	2.6	[128]
GHG emissions	€/tCO _{2eq}	9	28	52	61	68	75	100	150	[139]
GHG emissions by fuel type tCO _{2eq} /MWh _{th}										
Coal [140]		Oil [140]			Fossil gas [141]					
0.34		0.25			0.21					

Table A6: Efficiency assumptions for HVDC transmission lines [142].

Component	Power losses
HVDC line	1.6 % / 1000 km
HVDC converter pair	1.4%

Table A7: Power, heat, desalination and transportation demand for all major regions from 2015 to 2050

Region	Energy service demand by sectors	Unit	2015	2020	2025	2030	2035	2040	2045	2050
Europe	Power demand	[TWh _{el}]	3414	3595	3783	3979	4225	4542	4825	5112
	Heat demand	[TWh _{th}]	6598	6922	7187	7453	7697	7923	8184	8437
	Industrial heat demand	[TWh _{th}]	2385	2619	2933	3022	3199	3426	3572	3730
	Space heating heat demand	[TWh _{th}]	3795	3871	3809	3973	4029	4018	4126	4216
	Domestic water heating heat demand	[TWh _{th}]	417	432	446	459	470	479	486	491
	Biomass cooking heat demand	[TWh _{th}]	0	0	0	0	0	0	0	0
	Desalination demand	[m ³ /day]	4,549,392	10,102,200	23,324,136	55,245,744	120,805,920	207,250,200	250,752,096	263,730,792
	Transport demand									
	Road passenger	mil p-km	6,897,867	7,538,821	8,154,800	8,851,861	9,630,968	10,489,803	11,425,990	12,427,847
	Road freight	mil t-km	2,989,269	3,222,309	3,455,112	3,722,241	4,019,653	4,356,588	4,730,842	5,148,414
	Rail passenger	mil p-km	637,931	678,848	715,378	753,927	793,306	831,826	867,239	896,577
	Rail freight	mil t-km	639,257	657,836	675,631	698,398	733,931	775,782	829,324	889,228
	Marine passenger	mil p-km	45,973	51,988	59,227	68,074	78,974	92,424	108,976	129,241
	Marine freight	mil t-km	15612931	16541075	17,497,969	18,590,112	19,864,731	21,365,710	23,180,867	25,430,672
	Aviation passenger	mil p-km	1,427,534	1,703,643	2,038,913	2,497,776	2,989,426	3,739,331	4,578,753	5,458,807
Aviation freight	mil t-km	38,686	46,520	55,821	67,036	80,536	98,495	118,810	140,581	

Region	Energy service demand by sectors	Unit	2015	2020	2025	2030	2035	2040	2045	2050
Eurasia	Power demand	[TWh _{el}]	1033	1063	1094	1125	1158	1194	1231	1274
	Heat demand	[TWh _{th}]	3628	3832	4057	4300	4520	4757	5041	5333
	Industrial heat demand	[TWh _{th}]	1582	1766	2052	2026	2117	2222	2253	2332
	Space heating heat demand	[TWh _{th}]	1912	1925	1858	2120	2243	2371	2618	2827
	Domestic water heating heat demand	[TWh _{th}]	134	141	148	154	160	165	170	174
	Biomass cooking heat demand	[TWh _{th}]	0	0	0	0	0	0	0	0
	Desalination demand	[m ³ /day]	263,520	985,056	4,102,896	1,7015,928	59,751,264	163,526,328	343,258,056	392,054,304
	Transport demand									
	Road passenger	mil p-km	1,619,960	1,958,805	23,03,608	2,695,155	3,116,935	3,545,536	3,955,497	4,324,676
	Road freight	mil t-km	331,467	359,731	388,542	422,295	461,312	505,391	554,025	606,816
	Rail passenger	mil p-km	306,399	372,672	439,643	513,815	590,703	664,820	730,302	781,447
	Rail freight	mil t-km	2,056,606	2,152,698	2,253,836	2,372,584	2,507,093	2,654,071	2,809,145	2,966,581
	Marine passenger	mil p-km	969	1090	1232	1398	1592	1819	2081	2375
	Marine freight	mil t-km	2,917,032	2,997,836	3,087,380	3,219,801	3,424,558	3,730,130	4,159,702	4,730,529
	Aviation passenger	mil p-km	256,818	333,948	431,388	569,587	731,739	980,756	1,280,701	1,620,986
Aviation freight	mil t-km	8307	100,99	12,389	15,425	19,507	25,402	32,728	41,178	

Region	Energy service demand by sectors	Unit	2015	2020	2025	2030	2035	2040	2045	2050
MENA	Power demand	[TWh _{el}]	1103	1257	1431	1627	1853	2110	2408	2753
	Heat demand	[TWh _{th}]	1654	1866	2077	2306	2549	2775	2925	3074
	Industrial heat demand	[TWh _{th}]	1080	1246	1385	1514	1660	1792	1875	1975
	Space heating heat demand	[TWh _{th}]	310	327	368	440	508	572	612	635
	Domestic water heating heat demand	[TWh _{th}]	263	292	322	352	381	411	439	464
	Biomass cooking heat demand	[TWh _{th}]	2	2	1	1	1	0	0	0
	Desalination demand	[m ³ /day]	27,686,952	49,360,440	9,1705,776	17,2078,560	305,814,192	434,471,520	492,200,832	512,754,072
	Transport demand									
	Road passenger	mil p-km	1,657,368	1,979,321	2,348,754	2,815,534	3,406,197	4,151,369	5,082,919	6,231,021
	Road freight	mil t-km	441,341.8	537,877.2	647,502.8	784,903.4	958,506.8	1,178,570.2	1,456,928.7	1,807,114.7
	Rail passenger	mil p-km	24,066	28,254	32,929	38,629	45,557	53,879	63,653	74,750
	Rail freight	mil t-km	75,624	86,608	99,232	114,854	134,861	161,129	196,279	244,213
	Marine passenger	mil p-km	13,710	15,368	17,095	19008	21,291	24,119	27,586	31,696
	Marine freight	mil t-km	8,090,308	9,049,353	1,020,1705	11,732,820	13,747,902	16,266,301	19,290,108	22,913,051
	Aviation passenger	mil p-km	235,387	296,163	372,434	480,982	599,013	802,624	1,039,595	1294203
Aviation freight	mil t-km	18,344	23,283	29,787	38,765	51,135	68,873	90,874	116466	

Region	Energy service demand by sectors	Unit	2015	2020	2025	2030	2035	2040	2045	2050
SSA	Power demand	[TWh _{el}]	290	354	434	536	668	844	1090	1470
	Heat demand	[TWh _{th}]	773	870	989	1231	1388	1590	1865	2166
	Industrial heat demand	[TWh _{th}]	396	479	552	746	825	930	1094	1267
	Space heating heat demand	[TWh _{th}]	58	62	65	58	63	64	61	57
	Domestic water heating heat demand	[TWh _{th}]	218	246	313	392	484	590	709	842
	Biomass cooking heat demand	[TWh _{th}]	101	83	59	34	17	7	2	0
	Desalination demand	[m ³ /day]	331,848	629,472	1,444,944	3,191,880	5,426,568	6,898,632	7,483,296	7,742,736
	Transport demand									
	Road passenger	mil p-km	1,281,726	1,406,881	1,515,989	1,644,183	1,794,673	1,970,947	2,177,167	2,418,725
	Road freight	mil t-km	354,855	400,057	439,916	486,179	539,775	601,660	672,914	754,914
	Rail passenger	mil p-km	20,030	21,876	23,523	25,447	27,693	30,307	33,346	36,878
	Rail freight	mil t-km	123,083	133,221	144,233	156,416	169,857	184,597	200,613	217,870
	Marine passenger	mil p-km	4973	5862	7066	8689	10823	13538	16890	20924
	Marine freight	mil t-km	2,461,574	3,316,292	4,684,665	6,925,491	10,530,005	16,060,420	24,066,023	35,113,283
	Aviation passenger	mil p-km	116,590	145,538	186,613	252,822	330,308	448,708	586,943	737,459
Aviation freight	mil t-km	7305	11,200	18,035	30,404	52,599	92,376	155,661	247,320	

Region	Energy service demand by sectors	Unit	2015	2020	2025	2030	2035	2040	2045	2050
SAARC	Power demand	[TWh _{el}]	1357	1681	2078	2546	3153	3961	5014	6370
	Heat demand	[TWh _{th}]	4202	3929	3881	4128	4603	5189	5776	6394
	Industrial heat demand	[TWh _{th}]	1697	2199	2642	3027	3469	3946	4401	4893
	Space heating heat demand	[TWh _{th}]	464	543	537	582	627	684	749	799
	Domestic water heating heat demand	[TWh _{th}]	268	286	347	412	481	553	625	702
	Biomass cooking heat demand	[TWh _{th}]	1774	901	356	107	26	5	1	0
	Desalination demand	[m ³ /day]	1,231,200	4,136,640	16,023,912	63,231,168	217,281,408	494,832,336	658,630,464	701,757,120
	Transport demand									
	Road passenger	mil p-km	6,489,481	8,907,851	10,922,531	13,111,955	14,819,715	17,449,674	21,440,817	27,276,144
	Road freight	mil t-km	1,727,557	2,597,860	3,428,729	4,382,347	5,425,446	6,815,491	8,311,830	9,851,592
	Rail passenger	mil p-km	1,249,993	1,701,121	2,045,299	2,381,451	2,571,078	2,861,134	3,282,552	3,841,647
	Rail freight	mil t-km	1,160,978	1,482,860	1,708,943	1,899,698	2,055,932	2,289,321	2,555,638	2,911,701
	Marine passenger	mil p-km	15,384	21,845	31,517	45,383	64,117	87,757	115,668	146,653
	Marine freight	mil t-km	7,454,370	10,135,544	13,782,704	18,678,313	25,109,314	33,357,125	43,753,643	56,690,673
	Aviation passenger	mil p-km	301,607	407,200	569,530	826,467	1,147,888	1,710,832	2,440,801	3,315,743
Aviation freight	mil t-km	17,024	26,253	40,507	62,136	94,124	142,599	208,677	292,719	

Region	Energy service demand by sectors	Unit	2015	2020	2025	2030	2035	2040	2045	2050
NE-Asia	Power demand	[TWh _{el}]	6677	7210	7818	8502	9299	10198	11250	12462
	Heat demand	[TWh _{th}]	12,509	13,712	14,119	14,551	14,621	14,704	14,740	14,773
	Industrial heat demand	[TWh _{th}]	7543	8590	8724	8971	8760	8664	8526	8252
	Space heating heat demand	[TWh _{th}]	4066	4184	4400	4541	4789	4949	5112	5419
	Domestic water heating heat demand	[TWh _{th}]	854	931	992	1038	1071	1092	1102	1102
	Biomass cooking heat demand	[TWh _{th}]	46	7	3	2	1	0	0	0
	Desalination demand	[m ³ /day]	2,804,160	7,994,736	26,097,216	87,598,296	254,715,960	474,856,968	578,242,680	608,991,456
	Transport demand									
	Road passenger	mil p-km	12,719,889	15,785,196	18,260,566	21,370,205	25,095,862	29,288,535	33,602,591	37,499,194
	Road freight	mil t-km	2,551,885	3,007,456	3,352,744	3,779,917	4,294,221	4,887,873	5,529,287	6,156,459
	Rail passenger	mil p-km	1,302,825	1,465,258	1,585,160	1,721,203	1,860,785	1,981,209	2,050,153	2,033,683
	Rail freight	mil t-km	3,096,026	3,573,924	3,988,521	4,535,166	5,236,731	6,110,567	7,158,883	8,357,961
	Marine passenger	mil p-km	12,687	17,269	22,824	29,033	35,533	42,014	48,243	54,050
	Marine freight	mil t-km	18,623,695	23,932,757	29,394,320	34,667,517	39,677,215	44,583,749	49,708,508	55,455,655
	Aviation passenger	mil p-km	967,417	1,236,941	1,564,480	2,051,461	2,571,491	3,456,119	4,448,853	5,465,858
Aviation freight	mil t-km	42,286	61,666	85,958	114,730	147,844	189,142	234,678	282,541	

Region	Energy service demand by sectors	Unit	2015	2020	2025	2030	2035	2040	2045	2050
SE-Asia	Power demand	[TWh _{el}]	1162	1415	1710	2081	2439	2879	3422	4092
	Heat demand	[TWh _{th}]	2160	1827	1837	1947	2150	2311	2411	2518
	Industrial heat demand	[TWh _{th}]	1109	1294	1524	1708	1928	2086	2173	2264
	Space heating heat demand	[TWh _{th}]	58	62	68	76	80	86	96	109
	Domestic water heating heat demand	[TWh _{th}]	105	114	120	126	131	136	141	145
	Biomass cooking heat demand	[TWh _{th}]	888	358	124	37	10	3	0	0
	Desalination demand	[m ³ /day]	2,779,128	7,369,944	19,355,256	44,838,000	79,880,592	104,899,272	114,905,208	119,128,752
	Transport demand									
	Road passenger	mil p-km	3,276,773	3,668,606	4,031,159	4,481,577	5,036,396	5,719,296	6,566,857	7,632,732
	Road freight	mil t-km	581,696	665,214	740,927	834,004	947,087	1,083,544	1,248,632	1,450,351
	Rail passenger	mil p-km	190,801	210,391	229,883	254,465	284,849	321,433	364,310	413,403
	Rail freight	mil t-km	828,155	882,341	933,999	997,173	1,074,294	1,168,017	1,281,632	1,420,313
	Marine passenger	mil p-km	12,304	14,822	17,883	21,504	25,681	30,399	35,653	41,480
	Marine freight	mil t-km	5,801,632	7,254,658	9,087,397	11,379,054	14,170,403	17,475,187	21,328,721	25,830,601
	Aviation passenger	mil p-km	243,623	301,537	385,739	507,004	629,355	826,884	1,029,071	1,214,026
Aviation freight	mil t-km	13,221	18,773	26,706	37,868	53,126	74,635	101,428	132,630	

Region	Energy service demand by sectors	Unit	2015	2020	2025	2030	2035	2040	2045	2050
N-Am	Power demand	[TWh _{el}]	4660	4839	5026	5198	5388	5624	5874	6114
	Heat demand	[TWh _{th}]	5427	5796	5973	6157	6342	6540	6766	6986
	Industrial heat demand	[TWh _{th}]	2440	2723	2811	2906	2947	3049	3166	3279
	Space heating heat demand	[TWh _{th}]	2093	2127	2165	2205	2304	2357	2429	2502
	Domestic water heating heat demand	[TWh _{th}]	868	925	983	1039	1089	1133	1172	1205
	Biomass cooking heat demand	[TWh _{th}]	26	21	15	7	2	0	0	0
	Desalination demand	[m ³ /day]	719,640	2,170,920	8,078,952	34,477,848	132,354,024	302,608,680	392,081,760	416,196,456
	Transport demand									
	Road passenger	mil p-km	8,998,312	9,924,421	10,817,045	11,757,741	12,735,186	13,734,546	14,738,666	15,733,916
	Road freight	mil t-km	2,663,045	2,851,410	3,039,130	3,246,432	3,473,596	3,719,855	3,983,327	4,261,601
	Rail passenger	mil p-km	63,918	67,628	70,763	73,313	75,099	75,983	75,868	74,760
	Rail freight	mil t-km	2,766,188	2,943,269	3,121,590	3,314,898	3,521,833	3,740,352	3,967,978	4,202,277
	Marine passenger	mil p-km	6,882	8,324	10,182	12,465	15,110	18,029	21,139	24,351
	Marine freight	mil t-km	16,838,886	18,636,719	20,510,152	22,376,789	24,181,180	25,989,187	27,975,635	30,386,311
	Aviation passenger	mil p-km	1,586,821	2,104,660	2,463,538	2,931,992	3,447,950	4,159,368	4,966,043	5,837,770
Aviation freight	mil t-km	38,180	47,950	59,886	73,933	89,942	110,040	131,791	154,452	

Region	Energy service demand by sectors	Unit	2015	2020	2025	2030	2035	2040	2045	2050
S-Am	Power demand	[TWh _{el}]	648	714	787	865	957	1069	1196	1339
	Heat demand	[TWh _{th}]	1669	1802	1949	2139	2331	2539	2679	2820
	Industrial heat demand	[TWh _{th}]	1100	1268	1388	1549	1670	1809	1890	1969
	Space heating heat demand	[TWh _{th}]	174	196	248	283	346	402	445	491
	Domestic water heating heat demand	[TWh _{th}]	219	240	262	284	306	326	344	359
	Biomass cooking heat demand	[TWh _{th}]	176	98	52	24	9	2	0	0
	Desalination demand	[m ³ /day]	449,016	1,210,848	3,237,672	7,506,912	13,793,832	19,138,944	21,396,168	22,251,072
	Transport demand									
	Road passenger	mil p-km	3,162,527	3,542,610	3,919,806	4,371,557	4,909,597	5,548,799	6,306,022	7,194,284
	Road freight	mil t-km	1,065,615	1,189,755	1,290,424	1,408,179	1,545,837	1,707,181	1,896,860	2,119,157
	Rail passenger	mil p-km	8,733	9,630	10,481	11,462	12,586	13,874	15,360	17,068
	Rail freight	mil t-km	333,752	326,014	341,617	363,316	392,989	433,207	487,446	560,239
	Marine passenger	mil p-km	29,884	36,442	44,444	53,674	63,585	74,296	85,057	95,621
	Marine freight	mil t-km	5,316,820	6,171,848	7,260,775	8,659,529	10,414,325	12,540,522	15,055,772	18,011,018
	Aviation passenger	mil p-km	236,649	295,889	375,725	491,452	619,224	817,526	1,046,302	1,293,573
Aviation freight	mil t-km	12,287	16,199	21,654	29,279	39,737	54,625	73,184	94,735	

Region	Energy service demand by sectors	Unit	2015	2020	2025	2030	2035	2040	2045	2050
Global	Power demand	[TWh _{el}]	20,342	22,129	24,161	26,459	29,140	32,420	36,311	40,986
	Heat demand	[TWh _{th}]	38,620	40,559	42,070	44,215	46,202	48,329	50,389	52,502
	Industrial heat demand	[TWh _{th}]	19,332	22,185	24,011	25,469	26,574	27,923	28,948	29,961
	Space heating heat demand	[TWh _{th}]	12,929	13,296	13,517	14,278	14,988	15,503	16,249	17,055
	Domestic water heating heat demand	[TWh _{th}]	3347	3608	3933	4256	4573	4885	5188	5486
	Biomass cooking heat demand	[TWh _{th}]	3013	1471	609	213	66	18	4	0
	Desalination demand	[m ³ /day]	40,814,856	83,960,256	193,370,760	485,184,336	1,189,823,760	2,208,482,880	2,858,950,560	3,044,606,760
	Transport demand									
	Road passenger	mil p-km	46,103,903	54,712,512	62,274,258	71,099,767	80,545,530	91,898,505	105,296,525	120,738,540
	Road freight	mil t-km	12,706,730	14,831,669	16,783,028	19,066,497	21,665,434	24,856,152	28,384,647	32,156,417
	Rail passenger	mil p-km	3,804,580	4,555,556	5,152,935	5,773,588	6,261,529	6,834,339	7,482,654	8,170,083
	Rail freight	mil t-km	11,078,955	12,238,031	13,266,844	14,451,731	15,826,740	17,516,254	19,486,147	21,769,585
	Marine passenger	mil p-km	142,734	172,979	211,440	259,200	316,679	384,371	461,272	546,378
	Marine freight	mil t-km	83,098,579	98,015,187	115,484,134	136,204,485	161,092,564	191,338,835	228,486,519	274,525,504
	Aviation passenger	mil p-km	5,371,771	6,824,821	8,387,667	10,608,857	13,065,763	16,941,540	21,416,486	26,237,875
Aviation freight	mil t-km	195,597	261,889	350,675	469,493	628,450	856,062	1,147,679	1,502,438	

Table A8: Employment factors used in the estimation of jobs created during the energy transition from 2015 to 2050. (Abbreviations: C&I – Construction and Installation, O&M – Operation and Maintenance)

Technologies	Manufacturing [Job-yrs/MW]	C&I [Job-yrs/MW]	O&M [Jobs/MW]	Fuel [Jobs/PJ]	Decommissioning [Job-yrs/MW]	Ref.
Wind onshore	4.70	3.20	0.30		0.72	[143]
Wind offshore	15.60	8.00	0.20		2.99	[143]
PV Utility-scale	6.70	13.00	0.70		0.80	[143]
PV Rooftop	6.70	26.00	1.40		1.21	[144,145]
Biomass	2.90	14.00	1.50	29.90	0.32	[143]
Hydro Dam	3.50	7.40	0.20		2.22	[143]
Hydro RoR	8.75	18.50	0.50		5.55	[143]
Geothermal	3.90	6.80	0.40		0.21	[143]
CSP	4.00	8.00	0.60		1.33	[143]
Biogas PP	2.90	14.00	2.25	29.90	0.32	[143]
Waste-to-energy	2.90	14.00	2.25	29.90	0.32	[143]
Methanation	2.90	14.00	2.25		0.32	[143]
Coal PP (Hard Coal)	5.40	11.20	0.14	39.70	1.65	[143]
Nuclear PP	1.30	11.80	0.60	0.001 (Jobs/GWh)	0.95 (Jobs/MW)	[143]
OCGT	0.93	1.30	0.14	15.10	0.21	[143]
CCGT	0.93	1.30	0.14	15.10	0.21	[143]
Steam Turbine	0.93	1.30	0.14		0.21	[143]
PtH	1.86	2.60	0.28		0.21	[143]
ICE	0.93	1.30	0.21	15.10	0.44	[143]
Gas Storage	0.00	0.12	0.01		0.11	[146,147]
PtG	1.86	2.60	0.28		0.21	[146,147]
Battery Utility-scale	16.90	10.80	0.40		0.80	[148]
Battery prosumer	16.90	21.60	0.80		1.21	[148]
PHES	7.00	14.80	0.40		4.44	[143]
A-CAES	8.45	10.80	0.40		0.40	[143]
Transmission	Employment factor with regard to investments – 5045 jobs/b€					[149]

The decommissioning employment factors are derived from [150-152].